



Coahuila
Gobierno del Estado
Secretaría de Educación
y Cultura



On the Road to
EXCELLENCE
An EFL-Teacher's Handbook



Resource Materials
Volume II

ACKNOWLEDGMENTS

EDITORIAL DIRECTOR: ELSA PATRICIA JIMÉNEZ FLORES

COMPILED BY: ELSA PATRICIA JIMÉNEZ FLORES
MÓNICA CANTÚ MALTOS

CONSULTING REVIEWER: GRACIELA VALDEZ GONZÁLEZ

GRAPHIC DESIGN: LILIANA PATRICIA HERNÁNDEZ ELIZONDO
ELSA PATRICIA MORELOS JIMÉNEZ

Your comments and suggestions are very important in providing all teachers with the best quality in educational guidance. Please send all comments and suggestions to:

Secretaría de Educación y Cultura
Coordinación de Inglés
Blvd. Fco. Coss y Ave. Magisterio s/n
C.P. 25000 Saltillo, Coahuila, México

Copyright ©
First Edition 2009
Saltillo, Coahuila, México

PRESENTATION

To Our Esteemed English Teachers,

The Secretariat of Education and Culture of the State of Coahuila through the Sub Secretariat of Basic Education committed to increasing the level of excellence in teaching and in support of its English teachers has designed a series of manuals entitled "On the Road to Excellence". We would like to present our new title within this series: "Resource Materials".

The Resource Materials Manual contains a vast variety of activities, each with its instructions as well as patterns, when necessary, and a picture of the finished product. For this reason, it was necessary to divide it into two volumes.

Volume I includes art, bookmarks, book patterns, molds, borders, cards, costumes, crafts, foamy animals, and dolls.

Volume II includes festivities, games, masks, puppets, toys, mobiles, and paper tube activities.

This manual has the objective of strengthening the work of the teacher in the preschool, primary, and secondary levels. Besides reinforcing the five basic skills, students will have fun while learning through more dynamic and pleasant classes. The activities are the same for the three levels; the teacher will only have to adapt it to fit the needs of his/her students.

As always we wish you the best of luck and hope that this manual helps you to plan, organize, and direct more successful classes which will reflect in a higher achievement of all our students.

State English Coordination

ACTIVITY

PAGE

FESTIVITIES

CHILDREN'S DAY

| | |
|---------------------|---|
| BINOCULARS | 3 |
| MINI PURSE | 4 |
| PAPER TUBE BRACELET | 6 |
| WIND BOATS | 7 |

CHRISTMAS

| | |
|---------------------|----|
| CHRISTMAS BELLS | 9 |
| CHRISTMAS CRACKERS | 10 |
| CHRISTMAS REINDEER | 12 |
| CHRISTMAS STAR | 14 |
| CHRISTMAS STOCKINGS | 16 |
| GIFT BOXES | 19 |
| MINI CHRISTMAS TREE | 22 |
| MITTEN CARD | 23 |
| PAPER PLATE SNOWMAN | 26 |
| SNOWMAN 1 | 27 |
| SNOWMAN 2 | 29 |
| SODA CAN SNOWMAN | 31 |
| STAND UP ANGEL | 33 |

DAY OF THE DEAD

| | |
|----------------------|----|
| HOMEMADE SUGAR SKULL | 35 |
| PASTA SKELETON | 36 |
| SKELETON PUPPET | 38 |

EARTH DAY

| | |
|-------------------------|----|
| GRASS HEAD | 42 |
| MILK CARTON BIRD FEEDER | 43 |
| PINECONE PHOTO HOLDER | 44 |
| TWIG TRIVET | 45 |

FATHER'S DAY

| | |
|-------------------|----|
| #1 DAD ROSETTE | 46 |
| CAR PICTURE FRAME | 47 |
| HANGING DADS | 49 |
| T-SHIRT CARD | 51 |



ACTIVITY

PAGE

MOTHER'S DAY

| | |
|------------------------|----|
| HANGING HAND PLAQUE | 53 |
| READY TO BLOOM BOUQUET | 54 |
| WOVEN YARN BASKET | 55 |

VALENTINE'S DAY

| | |
|---------------------|----|
| 3-D HEART BANNER | 57 |
| CHOCOLATE MICE | 59 |
| FUN HEARTS BRACELET | 60 |
| POPCORN WREATH | 61 |
| TISSUE PAPER HEART | 62 |

GAMES

| | |
|-----------------------|----|
| BASKETBALL TOSS | 65 |
| BUTTON FLIP GAME | 66 |
| CHILDREN'S HORSESHOES | 68 |
| CRAFT STICK PUZZLE | 69 |
| FOOD MEMORY GAME | 70 |
| FRISBEE | 73 |
| GO DINOSAUR GO! | 74 |
| GO FISH | 76 |
| MATH TOSS MADNESS | 78 |
| POM-POM BASKETBALL | 81 |
| PUZZLES | 84 |
| SNAILS | 86 |
| TIC TAC TOE | 88 |

MASKS

| | |
|-----------|-----|
| BUTTERFLY | 95 |
| CAT 1 | 97 |
| CAT 2 | 99 |
| COW | 101 |
| DOG | 103 |
| ELEPHANT | 105 |
| GIRAFFE | 107 |
| LION | 109 |
| MONKEY | 111 |
| PIG | 113 |
| RABBIT | 114 |
| SHEEP | 116 |
| TIGER | 117 |
| ZEBRA | 119 |

ACTIVITY

PAGE

MOBILES

| | |
|----------------------------------|-----|
| BALLOON MOBILE | 123 |
| BREAKFAST MOBILE | 126 |
| BUTTERFLY MOBILE | 129 |
| CHRISTMAS MOBILE | 131 |
| COSMICALLY COOL MOBILE | 133 |
| DENTAL HEALTH MOBILE | 136 |
| EGG CARTON BUGGY MOBILE | 139 |
| FALL LEAVES MOBILE | 141 |
| FLOATING HOT-AIR BALLOONS MOBILE | 143 |
| GEOMETRY MOBILE | 145 |
| SEA MOBILE | 146 |
| SNAKE MOBILE | |

PAPER TUBE

| | |
|--------------|-----|
| BAT | 154 |
| BEAR | 155 |
| BEAVER | 156 |
| BEE | 157 |
| BUTTERFLY | 158 |
| CAT | 159 |
| CROCODILE | 160 |
| COW | 161 |
| DOG | 162 |
| DUCK | 163 |
| ELEPHANT | 164 |
| FOX | 165 |
| FROG | 166 |
| GOAT | 167 |
| HEN | 168 |
| HIPPOPOTAMUS | 169 |
| HORSE | 170 |
| KANGAROO | 172 |
| KOALA | 174 |
| LION | 175 |
| MONKEY | 176 |
| MOUSE | 177 |
| OCTOPUS | 178 |
| OWL | 179 |
| PANDA | 180 |
| PENGUIN | 181 |

ACTIVITY

PAGE

| | |
|----------|-----|
| PIG | 182 |
| RABBIT | 183 |
| SHEEP | 184 |
| SNAKE | 185 |
| SKUNK | 186 |
| SQUIRREL | 187 |
| TOUCAN | 189 |
| TURKEY | 190 |
| WALRUS | 191 |

PUPPETS

| | |
|-----------------------|-----|
| ALIEN PUPPETS | 195 |
| CHINESE DRAGON PUPPET | 197 |
| CLOTHESPIN PUPPETS | 198 |
| EGG CARTON CHARACTERS | 200 |
| ELEPHANT PUPPET | 201 |
| FINGER PUPPETS | 203 |
| MARIONETTE | 204 |
| PEANUT PUPPETS | 206 |
| PIE PLATE FISH | 207 |
| PUPPET GLOVE | 209 |
| SHADOW PUPPETS | 210 |
| SILLY SPOON PUPPETS | 214 |
| STAGE NECKLACE | 215 |
| STICK PUPPETS | 216 |

FOLDED PAPER PUPPETS

| | |
|-------------|-----|
| BASE PUPPET | 218 |
| BILLY GOAT | 219 |
| BLUEBIRD | 221 |
| BUMBLEBEE | 223 |
| COW | 225 |
| DRAGON | 227 |
| FROG | 229 |
| HIPPO | 231 |
| JACKRABBIT | 233 |

ACTIVITY

PAGE

PAPER MITT PUPPETS

| | |
|-------------|-----|
| BASE PUPPET | 235 |
| ALIEN | 236 |
| ASTRONAUT | 238 |
| BEAR | 240 |
| BEAVER | 242 |
| CAT | 244 |
| DOG | 246 |
| ELEPHANT | 248 |
| HEN | 250 |
| KNIGHT | 252 |
| LAMB | 254 |
| LION | 256 |
| MONKEY | 258 |
| MOUSE | 260 |
| OCTOPUS | 262 |
| PIG | 264 |
| PRINCESS | 266 |
| RACCOON | 268 |
| ROBOT | 270 |
| SNAIL | 272 |
| TORTOISE | 274 |
| WALRUS | 276 |
| WHALE | 278 |

TOYS

| | |
|------------------------------|-----|
| AMBULANCE | 283 |
| BULLDOZER | 284 |
| CEREAL BOX BRIDGE | 286 |
| CEREAL BOX SUITCASE | 287 |
| CHUBBY TURTLES | 288 |
| FIRE ENGINE | 290 |
| FIREWORKS AND MUSIC PINWHEEL | 292 |
| FISHING BOAT | 294 |
| FLYING SAUCER | 295 |
| HIGH SPEED TRAIN | 296 |
| HOW HIGH CAN YOU FLY? | 297 |
| INDOOR TENNIS RACKET | 298 |
| JAPANESE CARP KITE | 299 |
| JET PLANE | 300 |
| MILK CARTON TRAFFIC LIGHT | 302 |
| MINI GOLF | 303 |

ACTIVITY

PAGE

| | |
|----------------------------|-----|
| MINI VAN | 305 |
| MOON BUGGY | 306 |
| PAPER PINE TREES | 307 |
| POLICE VAN | 309 |
| PRETZEL LOG CABIN | 310 |
| ROCKING HORSE | 311 |
| ROWBOAT | 313 |
| SAILBOAT | 314 |
| SHOE BOX GARAGE | 315 |
| SPACE SHUTTLE | 316 |
| STEAM ROLLER | 317 |
| SUBMARINE | 319 |
| POPSICLE STICK TRAIN TRACK | 320 |

FESTIVITIES

BINOCULARS

MATERIALS

- 2 paper tubes (toilet paper tubes are fine)
- crayons, markers, paint
- yarn or string
- colored or clear cellophane
- 2 rubber bands
- scissors
- glue

INSTRUCTIONS

1. Color and decorate the paper tubes.
2. Attach a piece of cellophane to one end of each paper tube and secure with a rubber band.
3. Glue both paper tubes together.
4. Glue or tie yarn or string to the other end of the paper tubes (see example).

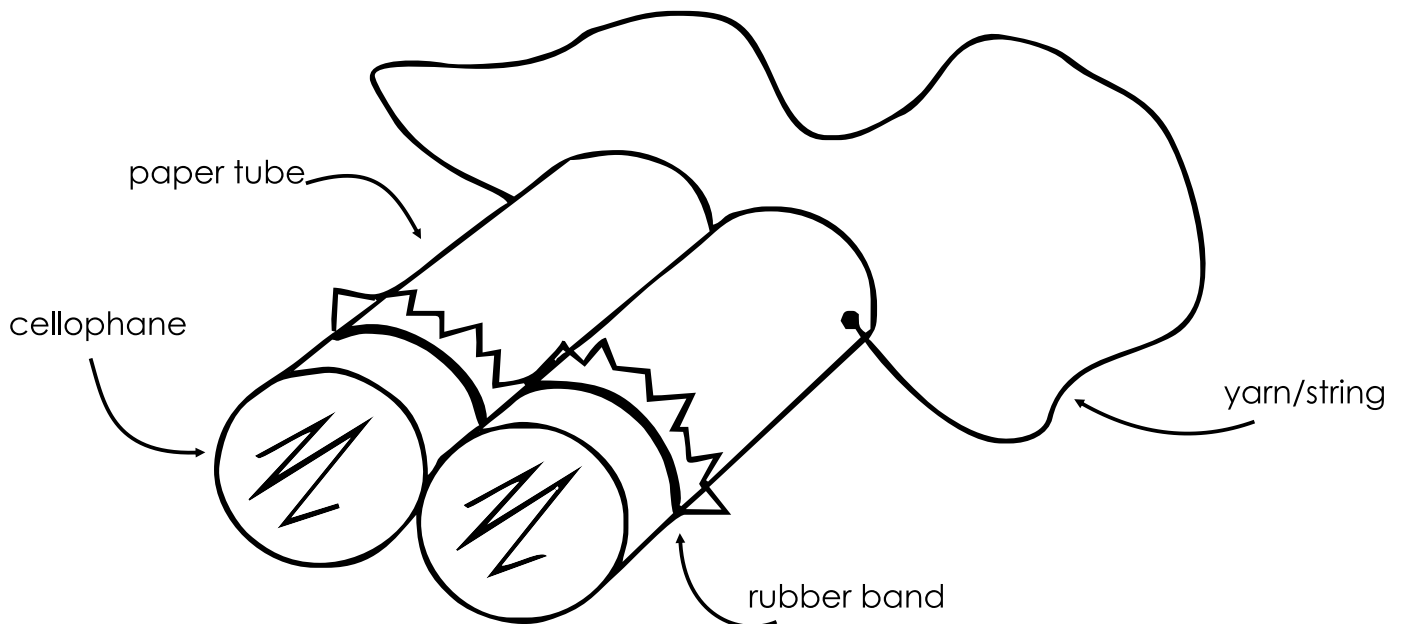

MINI PURSE

MATERIALS

- foamie sheet (letter size)
- 1 mt. yarn
- pattern (p. 5)
- scissors
- glue
- 1 cm. velcro piece
- hole punch
- optional material: buttons, stickers, glitter, etc.



INSTRUCTIONS

1. Trace the pattern onto the foamie sheet and cut out.
2. Fold the bottom flap upward and glue the sides. (see fig. 1) Let dry.
3. Punch two holes on the top flap. Thread yarn through to make the purse strap. (see fig. 2)
4. Glue the velcro piece to make the purse's clasp. (see fig. 3)
5. Use optional material to decorate your purse. (see example)

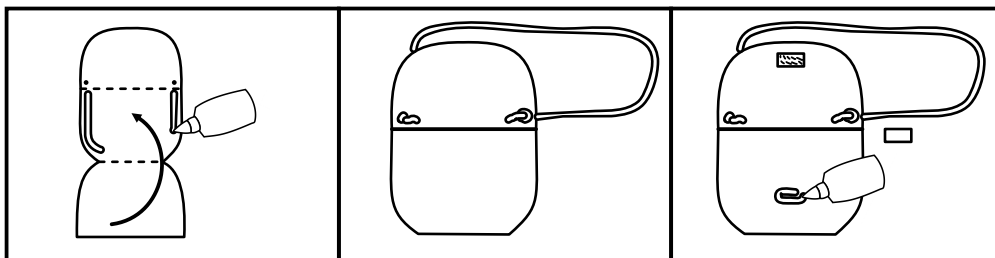
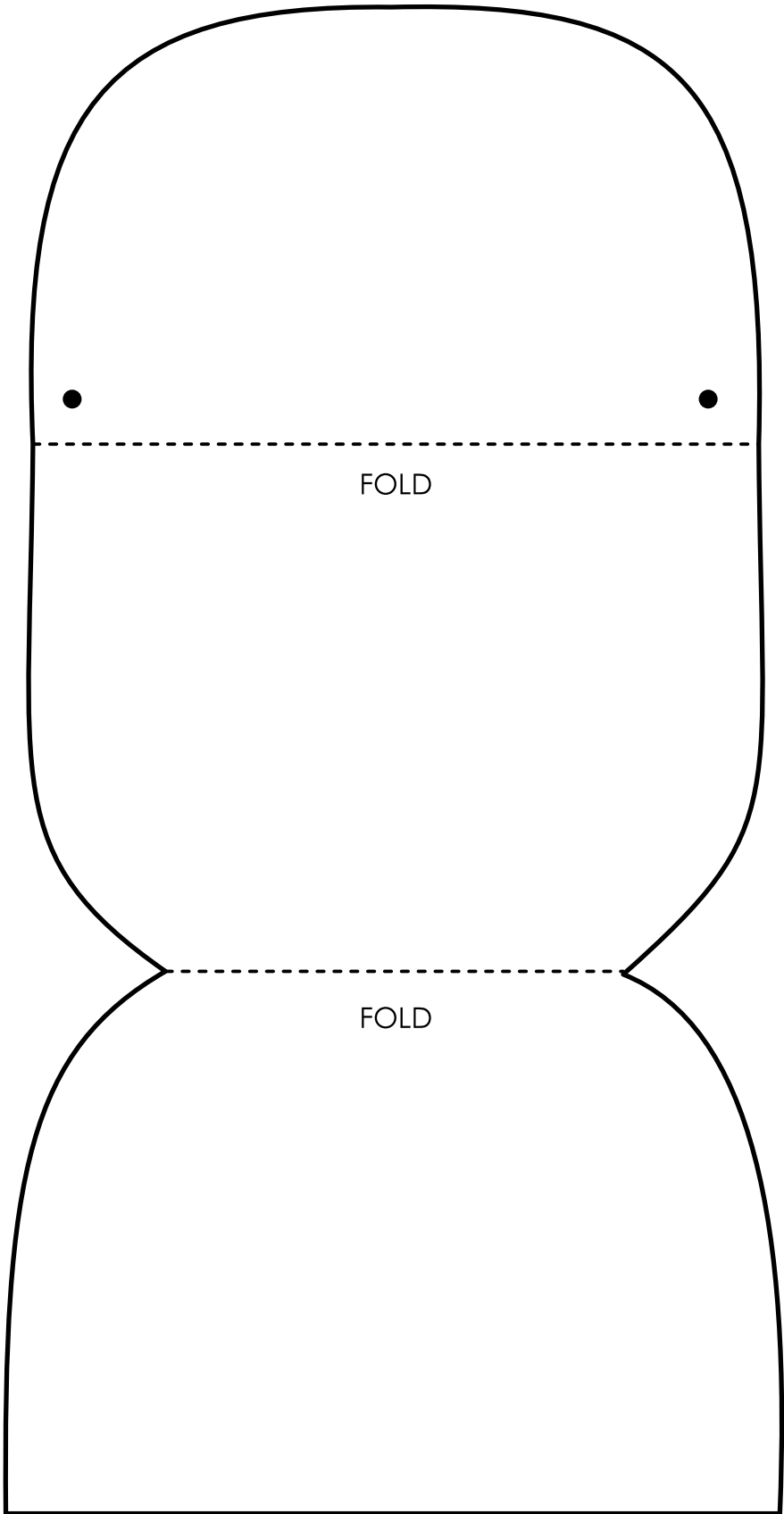

FIG. 1

FIG. 2

FIG. 3



PAPER TUBE BRACELET

MATERIALS

- paper tubes (girl's hand must fit through)
- decorations (glitter, buttons, beads, etc.)
- glue
- scissors

INSTRUCTIONS

1. Cut the paper tube any size you want. (1/4 tube is ok)
2. Glue on the decorations any way you like. Be creative.

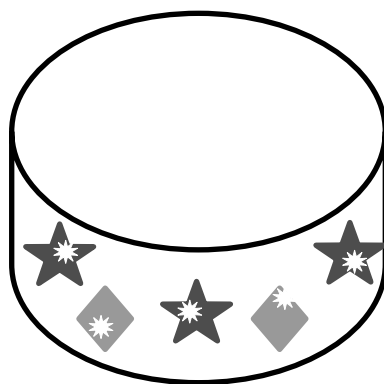

WIND BOATS

MATERIALS

- patterns (p. 8)
- scissors
- glue

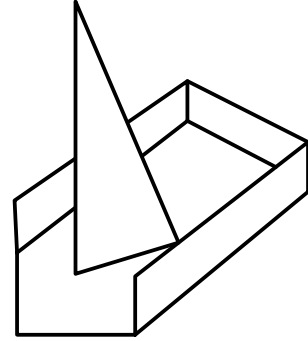

INSTRUCTIONS

1. Cut out the pattern pieces.
2. Fold the pieces along the dotted lines, and glue where indicated.
3. Place your boat on a table, and gently blow on the sail to make it move.

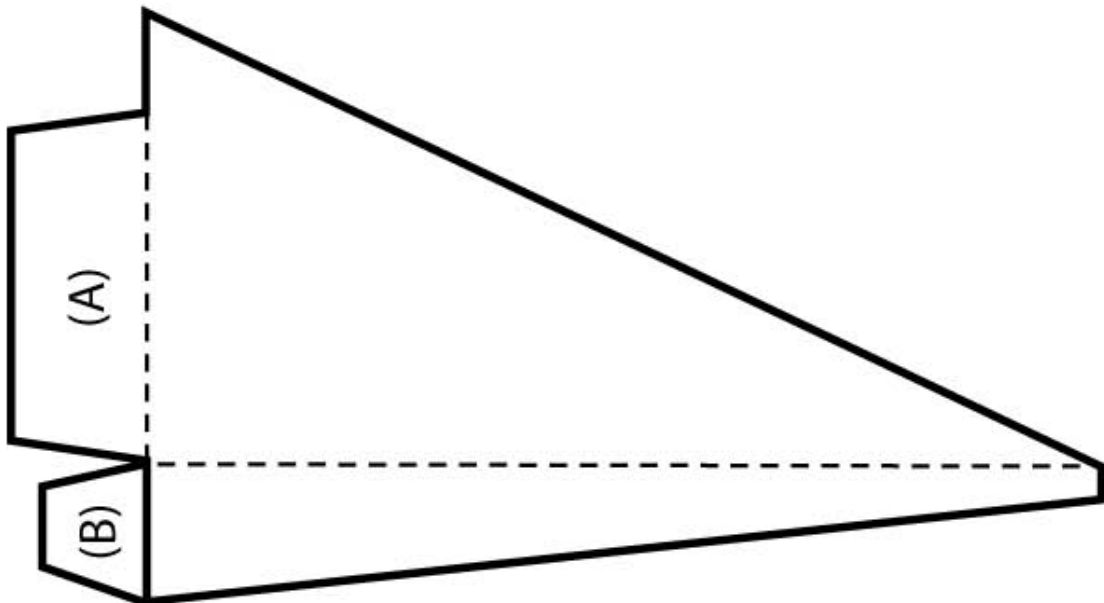
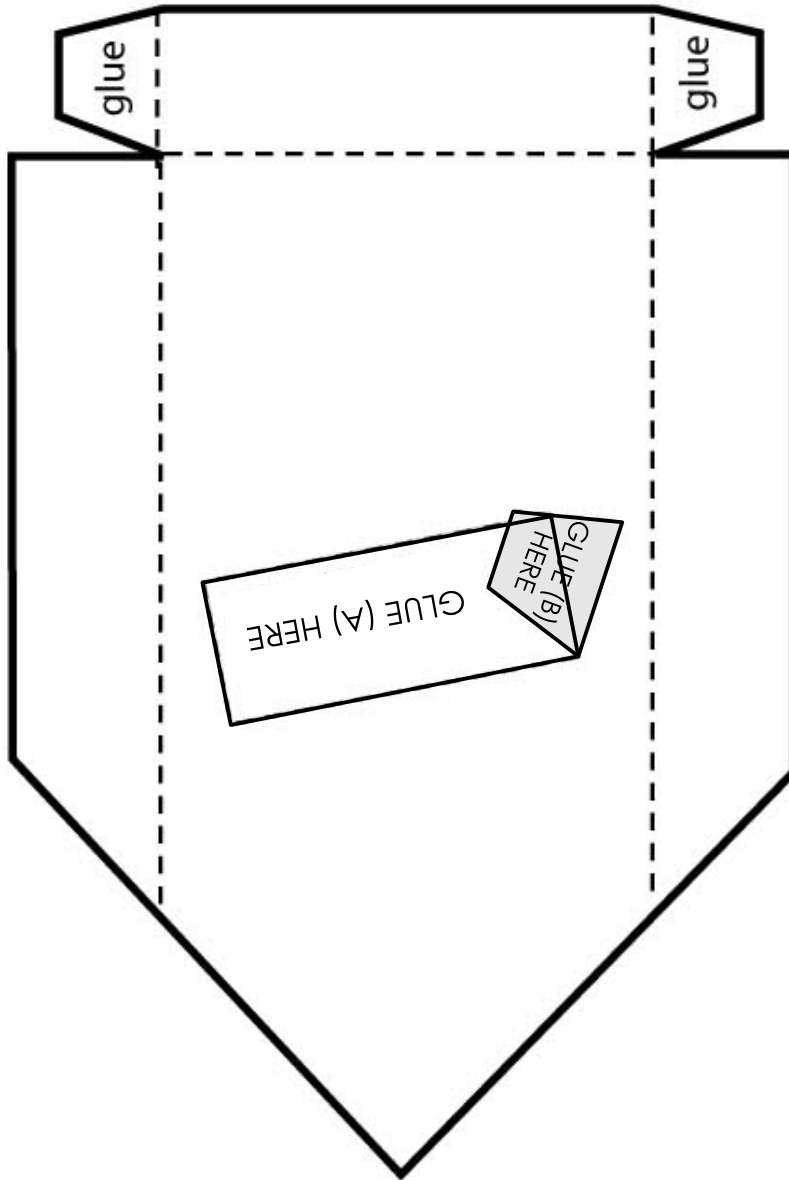

CHRISTMAS BELLS

MATERIALS

- egg carton
- scissors
- yarn or string
- small bells
- glue
- glitter
- paint (assorted colors)
- paintbrush
- sharp pencil

INSTRUCTIONS

1. Cut the egg carton into cups.
2. With the tip of the sharp pencil, poke a hole in the bottom of each cup.
3. Paint each cup in any way you like. Mix glitter into the paints for a quick sparkle effect.
4. Cut a piece of yarn or string 30 cms. long for each cup.
5. Tie a small bell to the end of each yarn piece.
6. Tie a small knot 2.5 cms. above the small bell. (see fig. 1)
7. Thread the yarn through the hole in the egg cup. Pull it all the way until the knot hits the inside of the cup. (see fig. 2)
8. Tie the remaining yarn into a loop, to hang from the tree. (see example)

* You can tie several bells to the bottom of a hanger. Decorate the rest of the hanger with ribbons or whatever you fancy and hang it from a door to hear jingle bells every time the door opens!

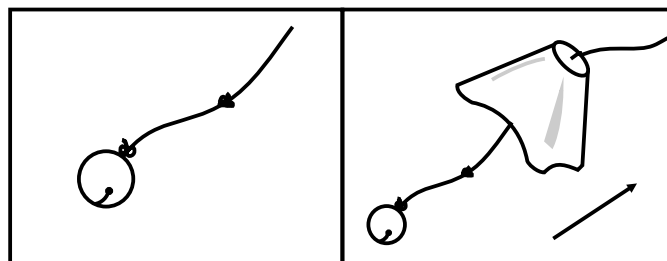
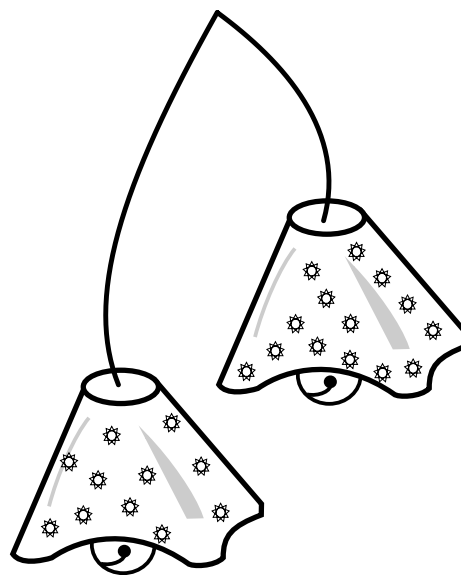

FIG. 1

FIG. 2

CHRISTMAS CRACKERS

MATERIALS

(for each tube)

- 1 cardboard tube, 10 cms. long and 4 cms. diameter (toilet paper tubes are ideal)
- 1 cardboard tube of the same size cut in half
- crêpe or gift wrapping paper for the outside cover
- string
- scissors
- ruler
- pencil
- clear glue
- decorations: stickers, ribbon, artificial flowers, dry flowers and leaves, magazine cut outs, beads, glitter, sequins, etc.
- small gifts to put inside the tube

INSTRUCTIONS

1. On crêpe or gift wrapping paper cut out a rectangle that is 14 cms. X 25 cms. long.
2. Place the toilet paper tube on the center of the rectangle, and the 2 half tubes at the sides. (see fig. 1)
3. Put glue at the top edge of the rectangle and roll with the paper tubes in to glue in place. (see fig. 1)



4. Cut two lengths of string 20 cms. long. Tie one at the space between the toilet paper tube and one half tube (don't tie too tight) .(see fig. 2)
5. Put in the small gift(s) through the open end of the tube.
6. Tie the second string between the toilet paper tube and the other half tube to close. (see fig. 2)
7. Decorate the tube as you like, using the materials available. (see figs. 2, 3, 4, and 5)
8. Pull out the two half tubes from the cylinder to let out all the surprises.

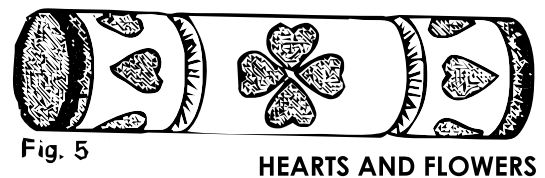
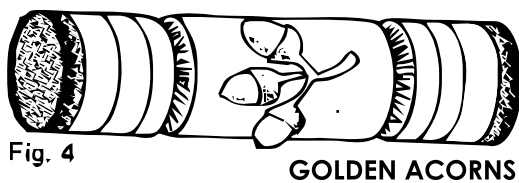
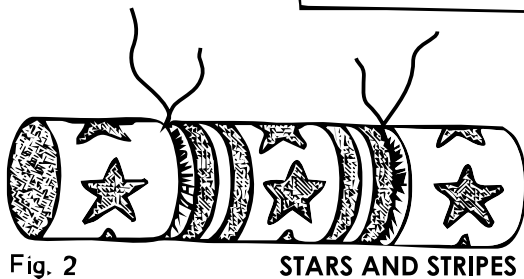
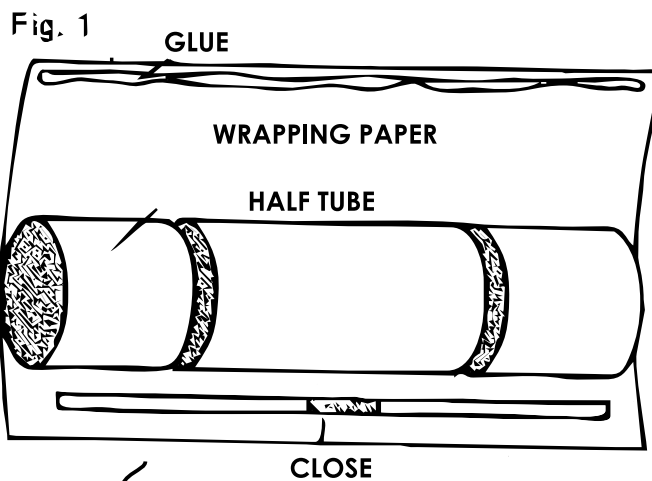

CHRISTMAS REINDEER

MATERIALS

- 1 dark brown and 1 light brown sheets of construction paper (letter size)
- colors, crayons, markers
- reindeer patterns (p. 13)
- glue
- scissors
- cardboard (folder, cereal box)

INSTRUCTIONS

1. Have each student trace the outline of his/her foot on the sheet of light brown construction paper.
2. Let them cut out the shape. This will be the reindeer's head.
3. Cut out and trace the antler patterns onto the dark brown construction paper and cut out.
4. Glue the antlers on the back at the top of the reindeer's head.
5. Color the rest of the patterns and glue onto the cardboard.
6. Cut out the patterns and glue on to make the reindeer's face.

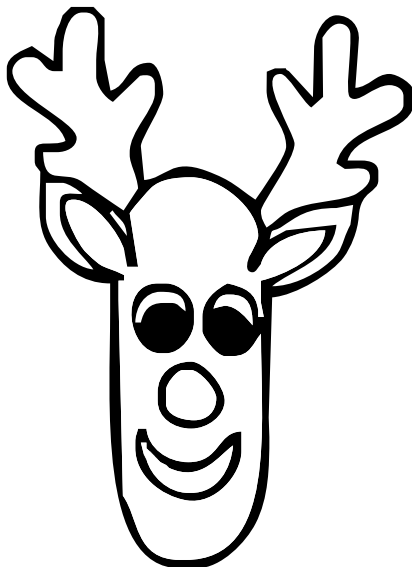

CHRISTMAS REINDEER PATTERNS

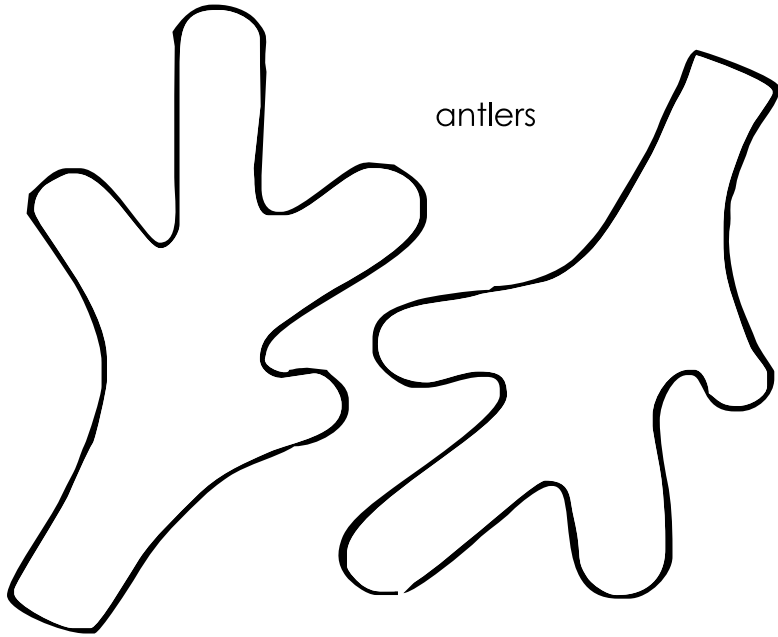

antlers

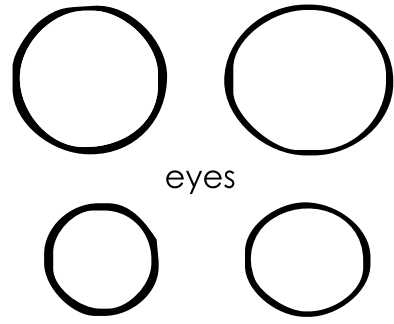

eyes

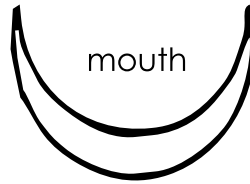

mouth

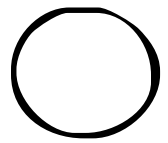

nose

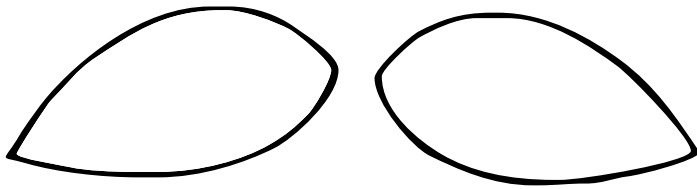

ears

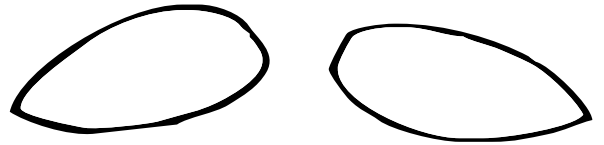

CHRISTMAS STAR

MATERIALS

- star patterns (p. 15)
- colored cardboard
- scissors
- yarn or string
- hole punch

optional materials:

- glue
- glitter
- sequins
- gift wrapping paper, etc.

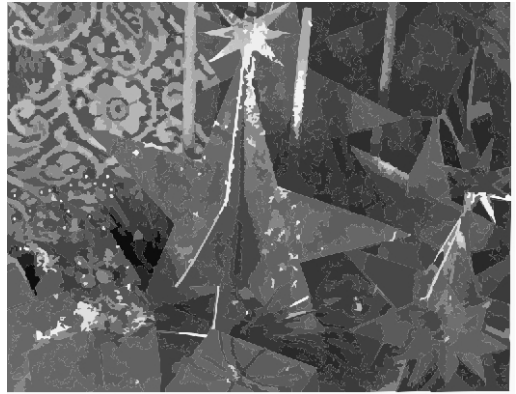

INSTRUCTIONS

1. Cut out along the solid line, and trace the star patterns onto the colored cardboard.
2. Cut along the center lines.
3. Interlock both stars at the center cuts to make a 3-D star.
4. Punch a hole at the top and tie some yarn to hang.
5. Use optional material to decorate the stars.

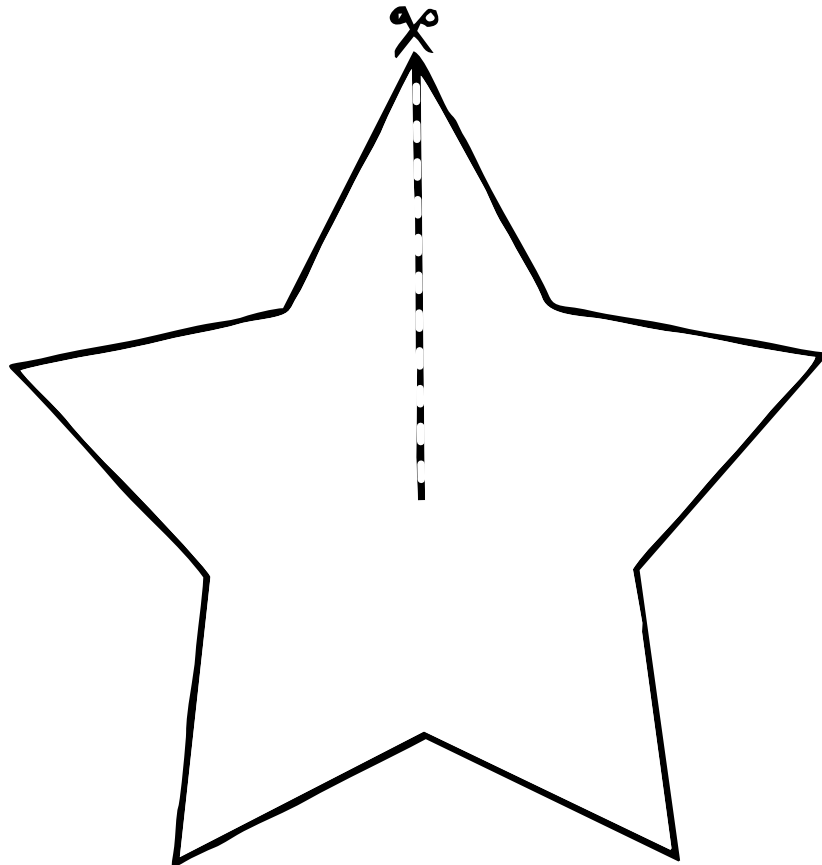
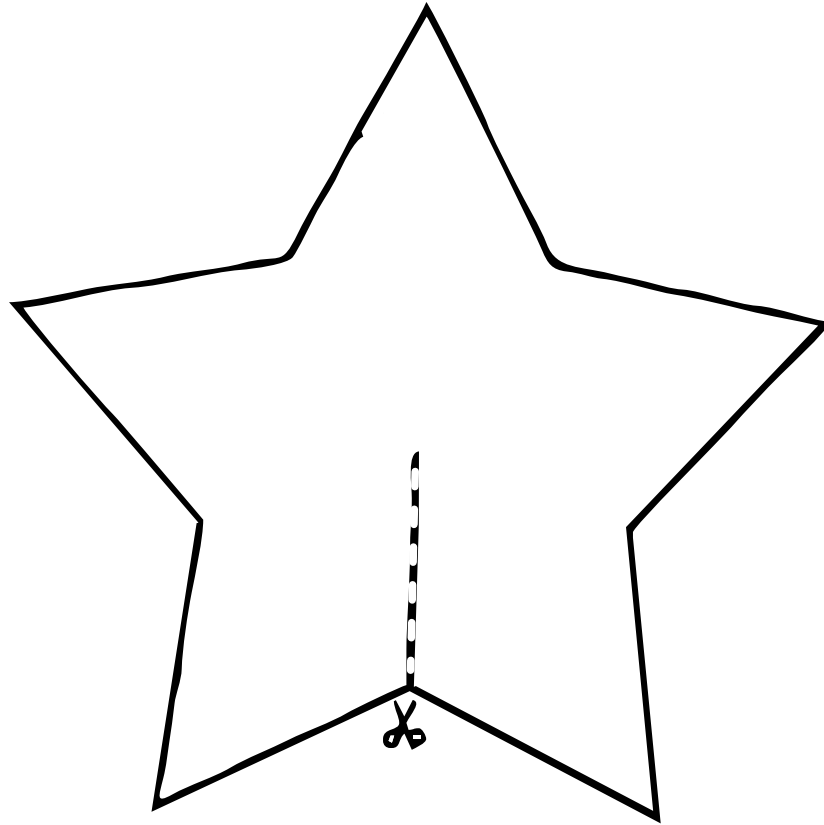

CHRISTMAS STOCKINGS

MATERIALS

- patterns (pp. 17, 18)
- material of your choice: felt, foamy, or construction paper (in assorted colors)
- scissors
- glue / glue gun
- pen
- decorating material: ribbon, glitter, sequins, jingle bells, etc.

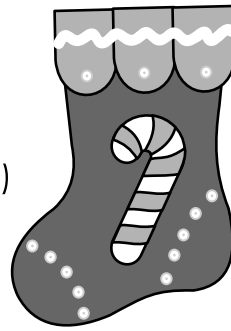

INSTRUCTIONS

1. Cut out the pattern pieces and trace them onto your chosen material. (Remember to trace two boot shapes for each stocking.) Cut out.
2. Put glue around the edge of one boot shape, except for the top. (see fig. 1) Put the second boot shape on top and press to glue in place.
3. Use the rest of the patterns and/or decorating material to finish your Christmas stocking. (see example)

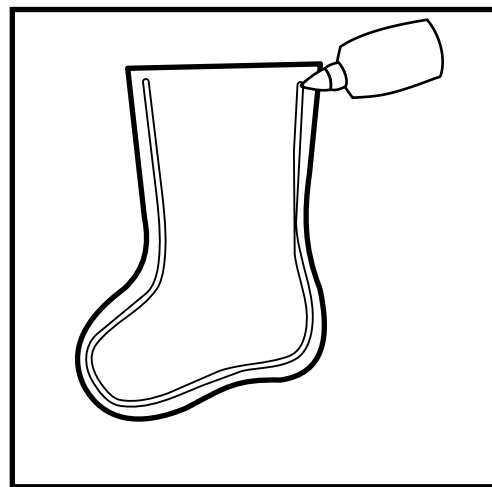
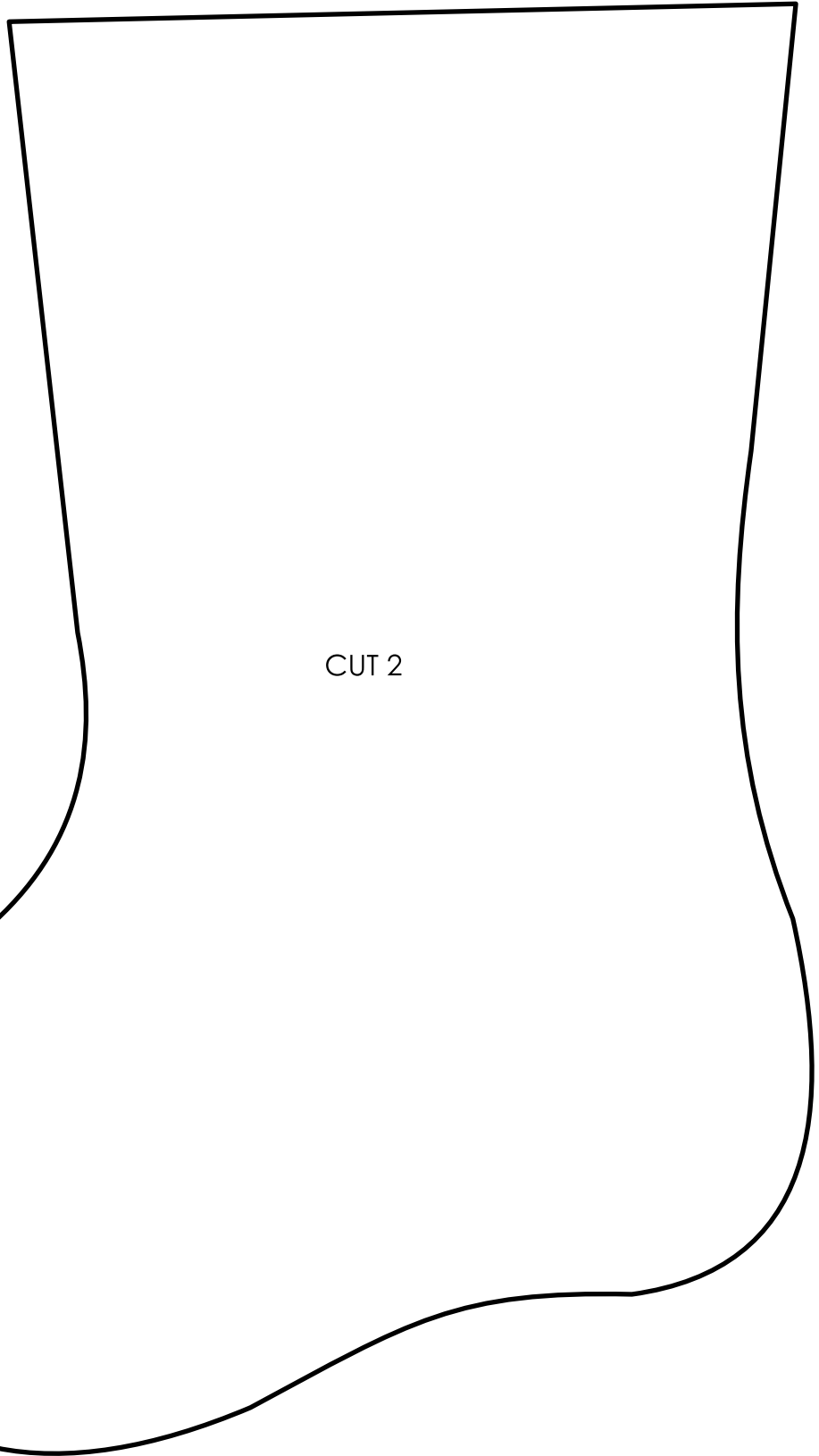
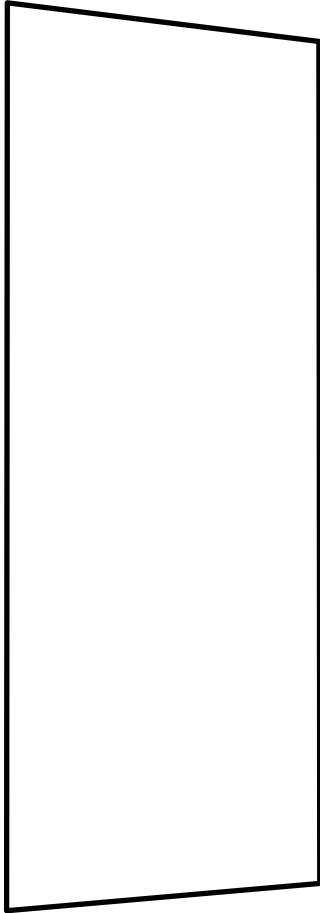

FIGURE 1

CHRISTMAS STOCKINGS PATTERNS



CUT 2

CHRISTMAS STOCKINGS PATTERNS

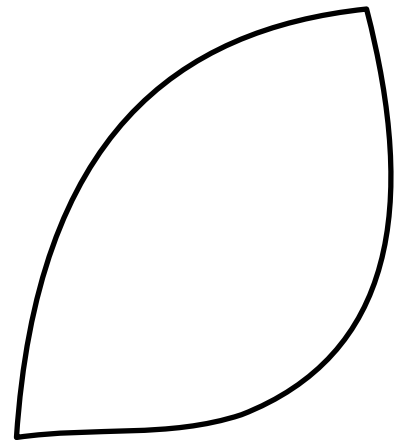
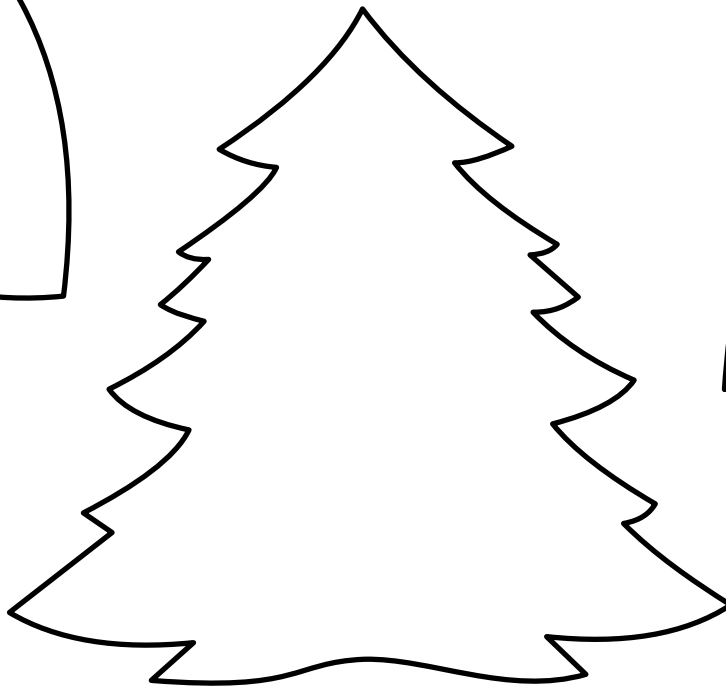
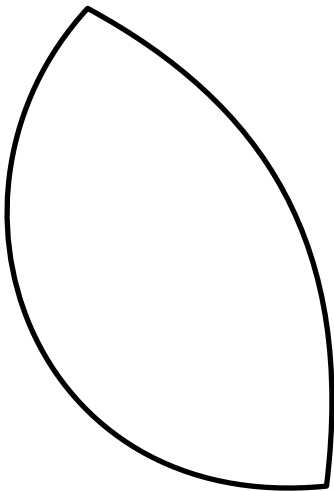
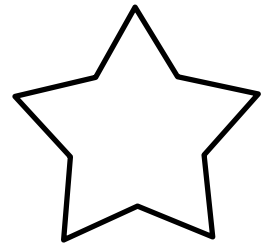
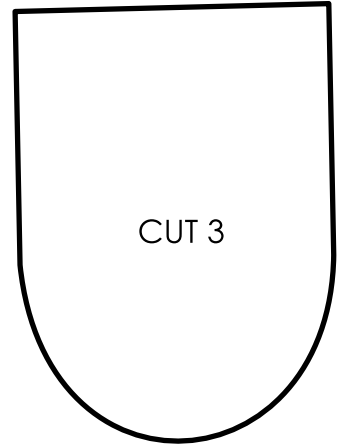
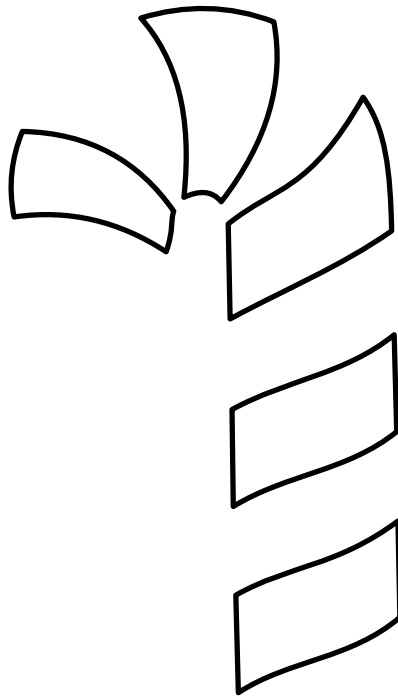
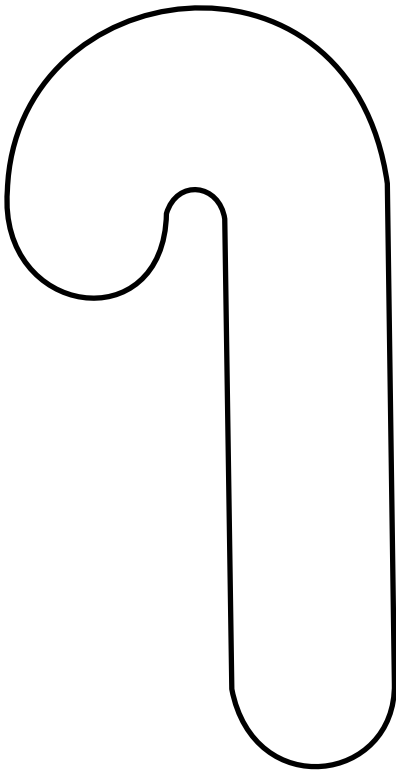

GIFT BOXES

MATERIALS

- colored cardboard
- scissors
- glue
- box patterns (pp. 20, 21)
- yarn or ribbon
- hole punch
- gift wrapping paper

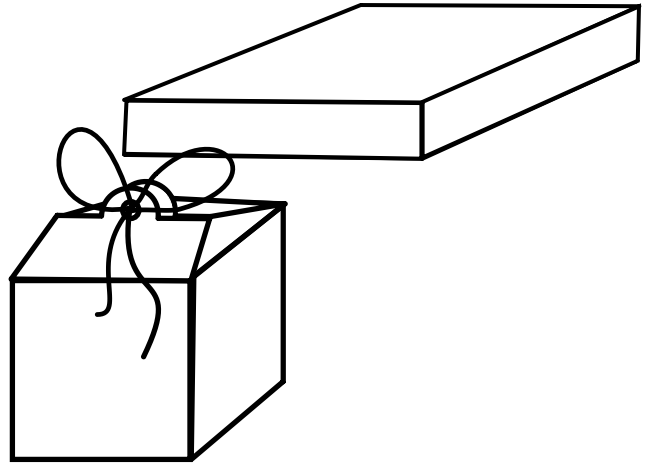

INSTRUCTIONS

1. Trace the pattern(s) onto colored cardboard and cut out.
2. Glue onto gift wrapping paper if you wish a different design and cut out.
3. Fold along the dotted lines to assemble.
4. For pattern #1, glue **a** and **b** on top of **A** and **B**.
5. For pattern #2, glue the shaded areas to the sides, punch a hole at the hole marks and tie closed with a ribbon.

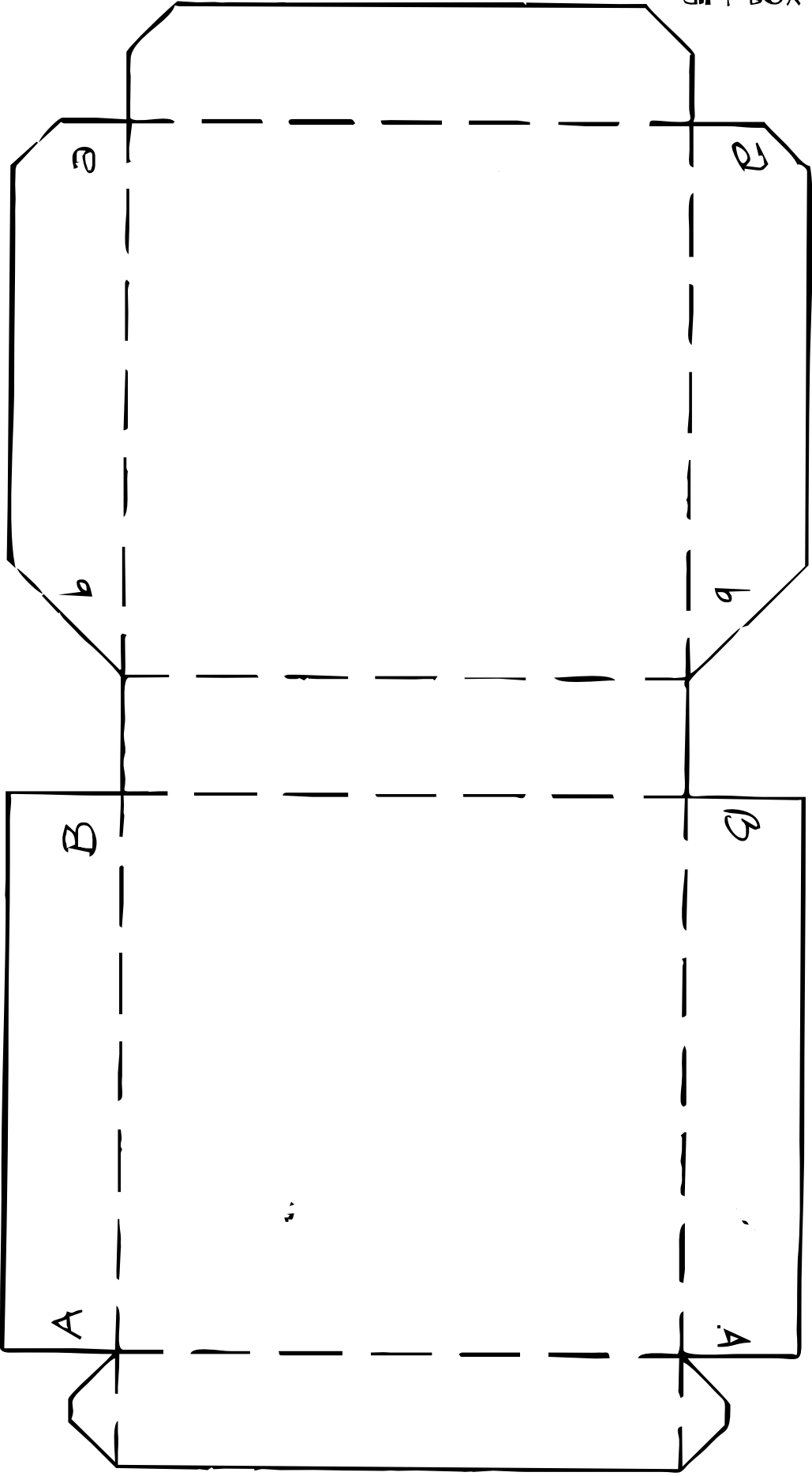

GIFT BOX PATTERN

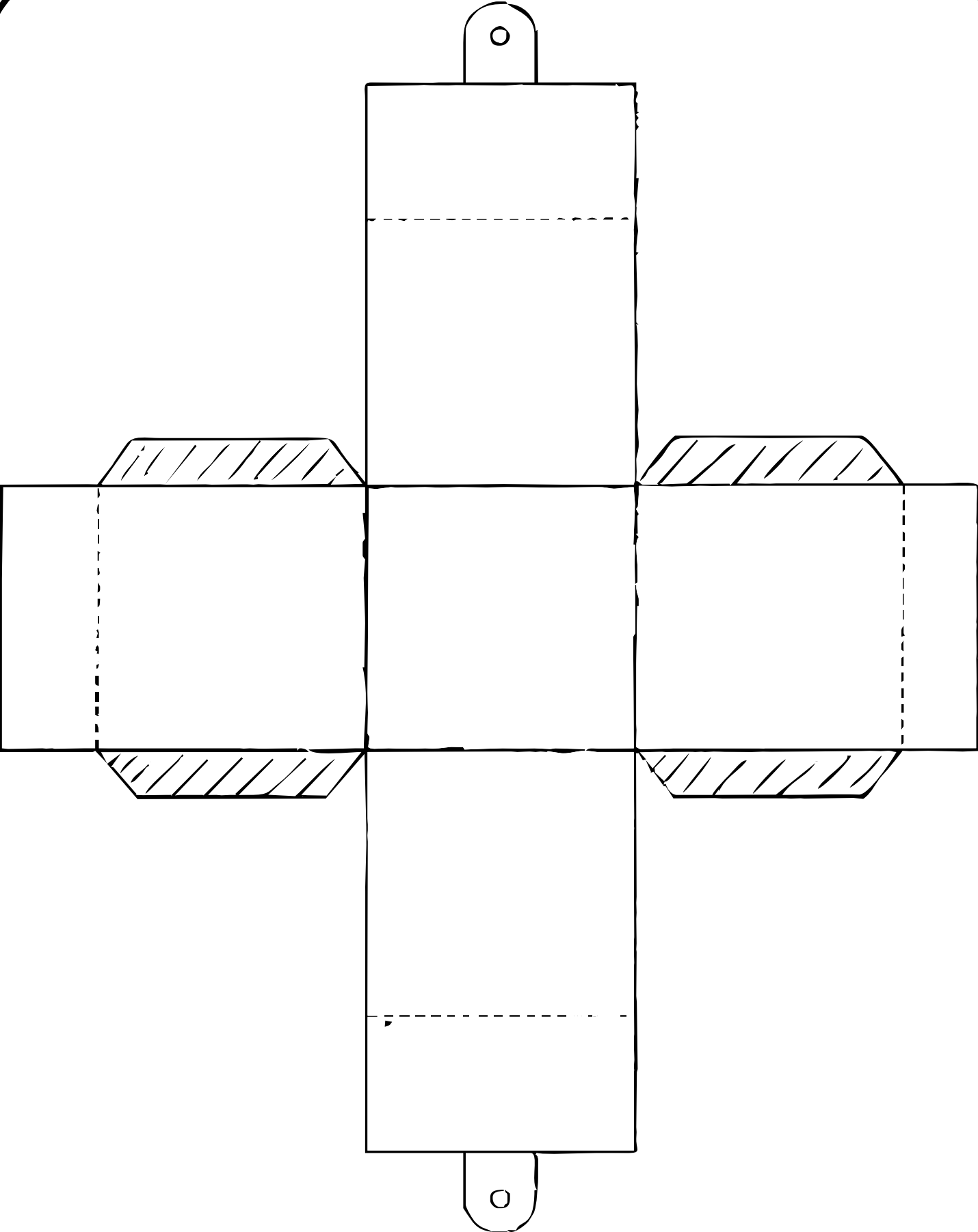

MINI CHRISTMAS TREE

MATERIALS

- newspaper (to cover work area)
- pine cone
- green spray paint
- glue
- glitter

INSTRUCTIONS

1. Spread out the newspaper to cover your work area (in a well ventilated room).
2. Put the pine cone on the newspaper and cover it with green spray paint; let it dry.
3. Drizzle some glue over the top of the pine cone.
4. Sprinkle glitter on the wet glue and allow it to dry.

Extra ideas

- * Punch out or buy colored confetti and glue it on as tiny decorations.
- * Make a mini star to glue on top of your mini Christmas tree.



MITTEN CARD

MATERIALS

- patterns (p. 25)
- red, white, green, and yellow construction paper
- glue
- ruler
- scissors
- pencil
- fine marker
- OPTIONAL: large hole punch, small hole punch, glitter, sequins, etc.

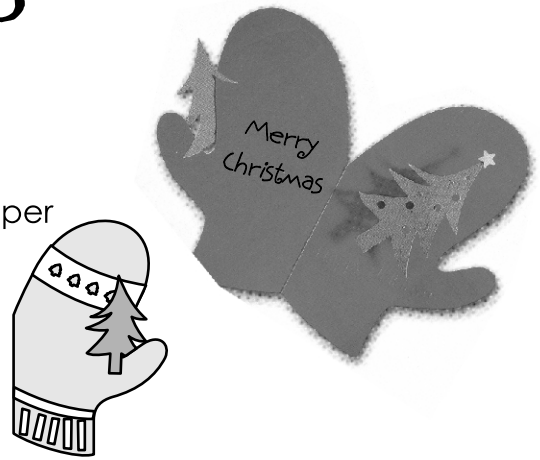

INSTRUCTIONS

1. Cut out the pattern pieces and trace onto indicated construction paper color. Trace four small red trees. Cut out.
2. Decorate the front of the card gluing the pattern pieces in place. (see example) Place the small green tree between the thumb and the body of the mitten, tucking some branches to the back of the card front. Glue in place.
3. Cut two 15 x 1.5 cm strips of red paper. Glue the end of one strip to the end of the other strip. (see fig. 1)
4. Fold the paper strips as shown on figs. 2 - 4 until you reach the end to make a spring.
5. Glue one end of the spring to the back of the large green tree. Glue the other end to the inside of the card.
6. Use the hole punches to punch holes in the large tree for ornaments, or decorate with glitter, sequins, etc. Glue the yellow star to the top of the tree.
7. Use the fine marker to write a Christmas message in your card.

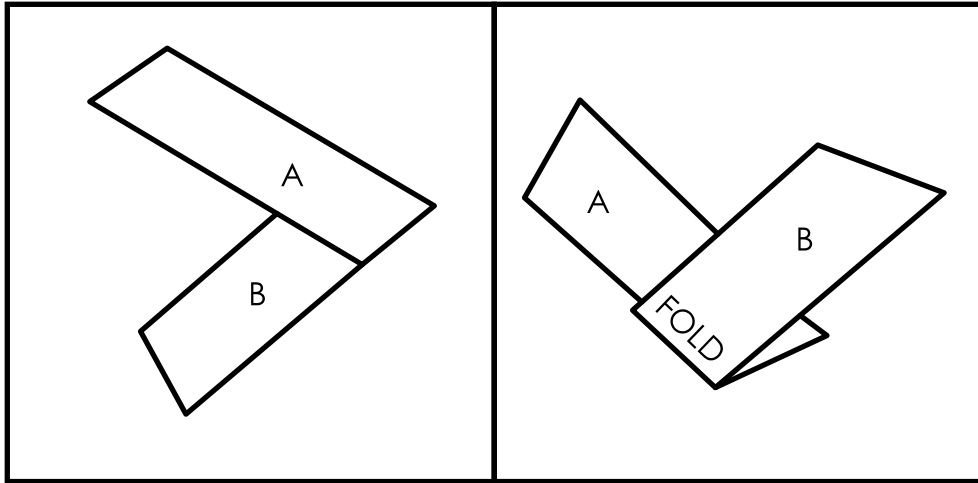

FIGURE 1

FIGURE 2

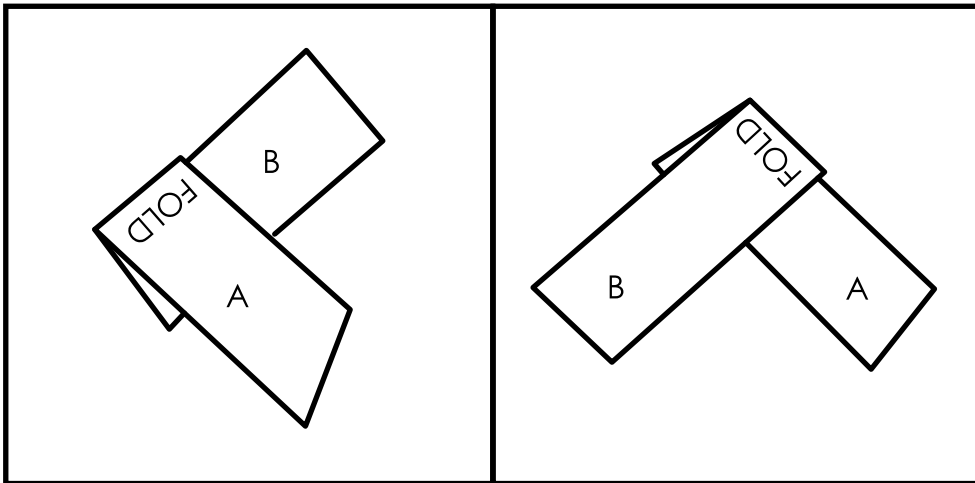
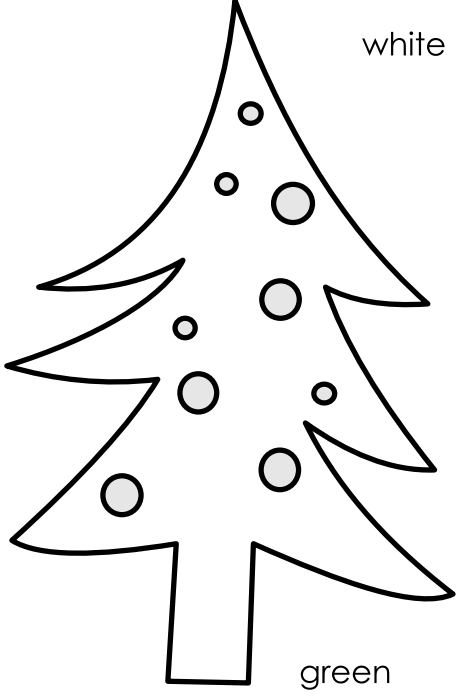
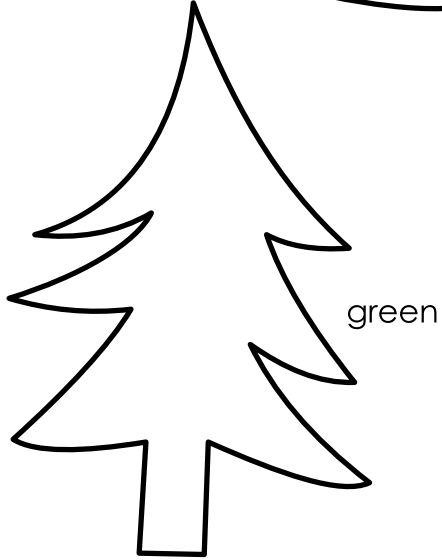
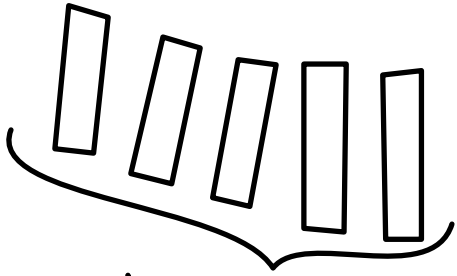
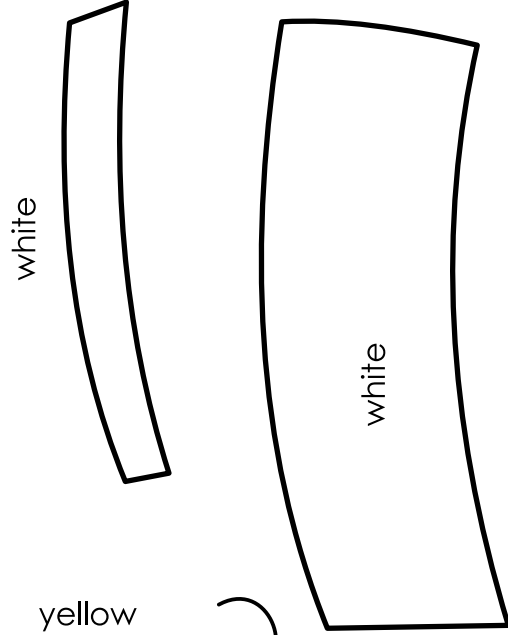
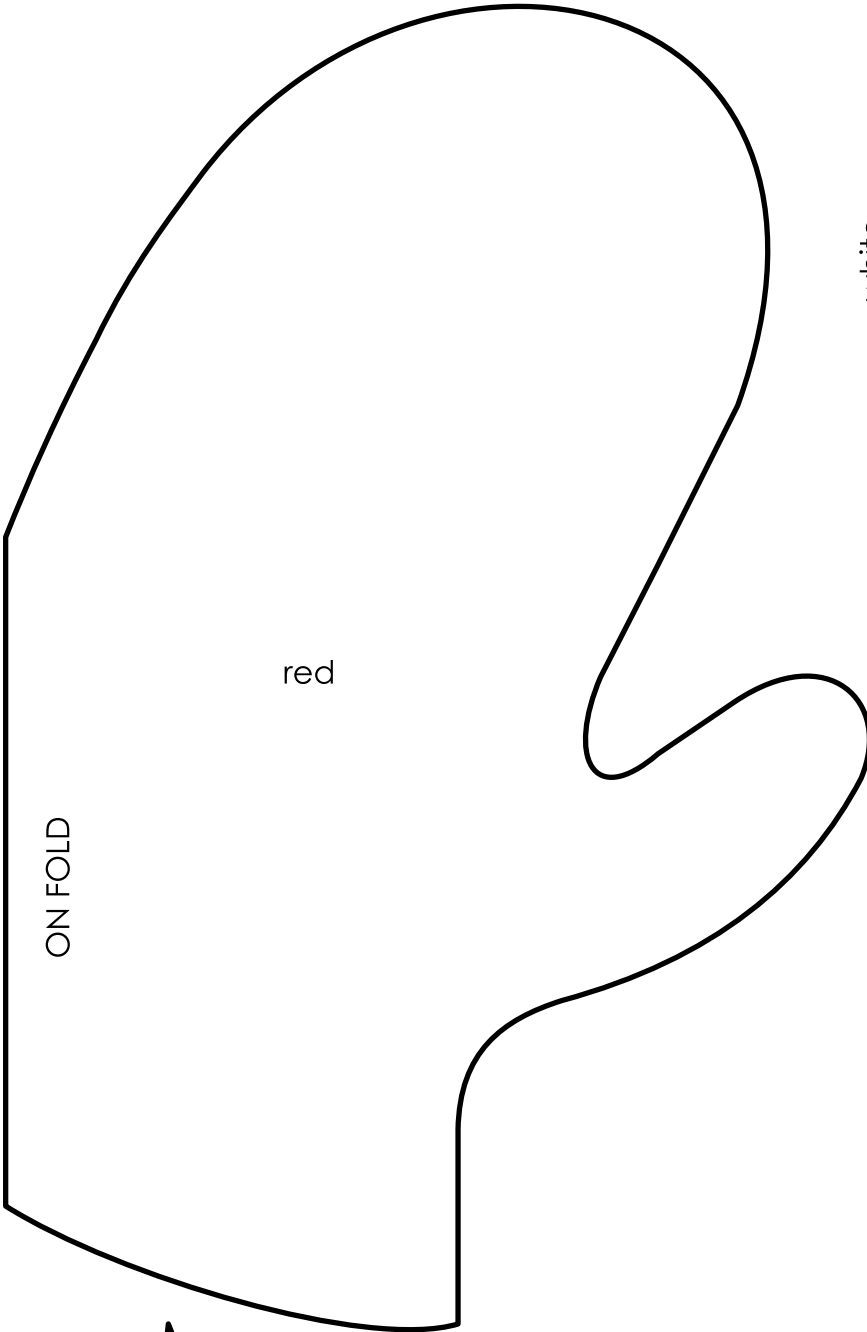

FIGURE 3

FIGURE 4

MITTEN CARD PATTERNS



PAPER PLATE SNOWMAN

MATERIALS

- 2 white paper plates
- construction paper (black, red)
- 1 orange pipe cleaner
- yarn or ribbon
- scissors
- glue

optional materials:

- googly eyes
- buttons



INSTRUCTIONS

1. Cut around one paper plate to make a smaller circle.
2. Glue both paper plates together, in a snowman's shape.
3. Draw a hat, mittens and boots on the construction paper.
4. Cut them out and glue onto the snowman shape.
5. Cut and glue a piece of orange pipe cleaner to make a nose.
6. Make a bow with the yarn or ribbon and glue onto the snowman's neck.
7. Draw or glue on eyes and buttons.

SNOWMAN # 1

MATERIALS

- 2 liter plastic soda bottle
- white and black acrylic paint
- sponge brush
- fine grain sandpaper
- red and black felt
- pipe cleaners in Christmas colors
- craft glue (Uhu) or hot glue gun
- plastic spray can cap
- plastic container lid (butter tub or similar size)
- pebbles, sand or dirt (to fill bottle halfway)
- scissors
- cutter
- black marker

INSTRUCTIONS

1. Sand the soda bottle, the spray can cap and the tub lid.
2. Paint the spray can cap and the tub lid black and let dry.
3. Paint the soda bottle white and let dry.
4. Cover the top and the sides of the spray can cap and the top of the tub lid with black felt and glue in place.
5. Center and glue the spray can cap to the tub lid to make the snowman's hat.
6. Turn the hat over and cut a hole in the bottom with the cutter. Make the hole a bit smaller than the circumference of the spray can cap.
7. Fill the bottle halfway with pebbles, sand or dirt.
8. Cut a strip of red felt about 60 cms. long and 5 cms. wide. This will be the snowman's scarf.

9. Tie the scarf around the bottle at about 15 cms. from the top. Glue in place.
10. Use 3 pipe cleaners to make the snowman's earmuffs. Coil 2 of them and attach each one to an end of the remaining pipe cleaner.
11. Glue the earmuffs in place, draping them across the back/top of the bottle.
12. Glue the hat to the top of the bottle. Decorate the hat with pipe cleaners.
13. Draw a face using a black marker or black paint.
14. Draw buttons beneath the scarf or glue on black felt circles.



SNOWMAN # 2

MATERIALS

- 1 liter plastic soda bottle
- sand, dirt or pebbles (to fill bottle halfway)
- styrofoam ball (7 cms. diameter, approx.)
- white and black acrylic paint
- paintbrush
- fine grain sandpaper
- black felt
- black buttons
- Christmas ribbon (1 mt. approx.)
- hot glue gun
- plastic spray can cap (hairspray)
- 1 lt. plastic container lid
- scissors

INSTRUCTIONS

1. Sand the soda bottle, spray can cap and plastic lid.
2. Paint the spray can cap and the plastic lid black and let dry.
3. Paint the soda bottle white and let dry.
4. Cover the top and the sides of the spray can cap and the top of the plastic lid with black felt and glue in place.
5. Center and glue the spray can cap onto the plastic lid to make the snowman's hat.
6. Remove the lid from the soda bottle and fill halfway with the pebbles or sand.
7. Squeeze or push the styrofoam ball down into the top of the soda bottle. If you need to, you can carve out a hole in the ball using the scissors.
8. Glue the head in place.

9. Tie a long piece of ribbon around the snowman's neck.
10. Tie a second piece of the same ribbon around the snowman's hat.
11. Glue the hat onto the snowman's head.
12. Glue the buttons onto the styrofoam ball to make the snowman's face.
13. Cut small circles of black felt and glue them onto the snowman's belly.



SODA CAN SNOWMAN

MATERIALS

- 1 clean, dried aluminum can
- white construction paper
- 1 full sheet (2 – fold) of newspaper
- masking tape
- white and black paint
- paintbrush
- fiberfill or quilt batting
- cloth fabric 50 cms. x 2.5 cms.
- 1 spray can cap
- 1 orange pom-pom (medium)
- 2 googly eyes
- hot glue gun
- scissors



INSTRUCTIONS

1. Wrap the entire can with white construction paper and glue in place.
2. Use the full sheet of newspaper and scrunch it into a ball shape.
3. Tape it to the top of the can (this will be the head).
4. Cover the newspaper ball in masking tape.
5. Paint the taped newspaper ball with the white paint and let it dry.
6. Glue the fiberfill onto the body of the snowman (can).
7. Draw a circle that is bigger than your spray can cap and glue it onto the cap to make a hat's brim.
8. Paint the hat with the black paint.

9. Glue the googly eyes and the orange pom-pom onto the snowman's head to make a face.
10. Glue the hat on top of the head.
11. Use your cloth fabric to tie a scarf around the snowman's neck. Trim if necessary.

STAND UP ANGEL

MATERIALS

- angel pattern (p. 34)
- cardboard (folder, cereal box)
- colors, crayons, markers
- glue or tape
- scissors
- a drinking straw

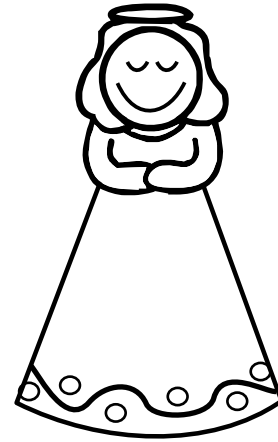

INSTRUCTIONS

1. Color and decorate the angel patterns (draw a face).
2. Glue the patterns onto the cardboard and cut out along the solid line.
3. Make a cone shape with the angel's dress, joining flap **a** with side **b** and glue or tape in place.
4. Cut the drinking straw in half and glue or tape one half to the back of the angel's body, leaving a segment sticking out.
5. Slide the part of the straw that sticks out of the angel's body through the top of the angel's dress.

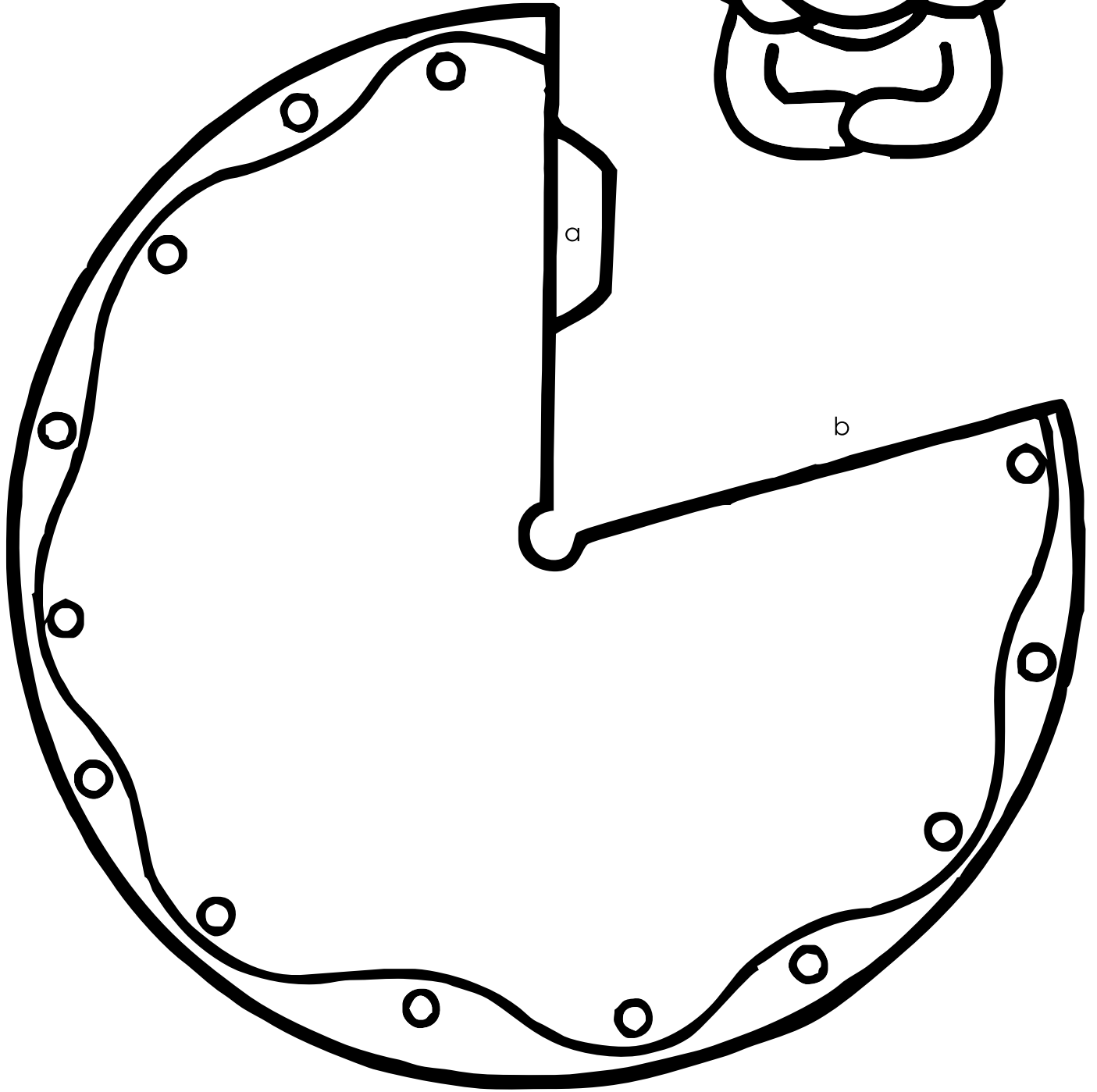
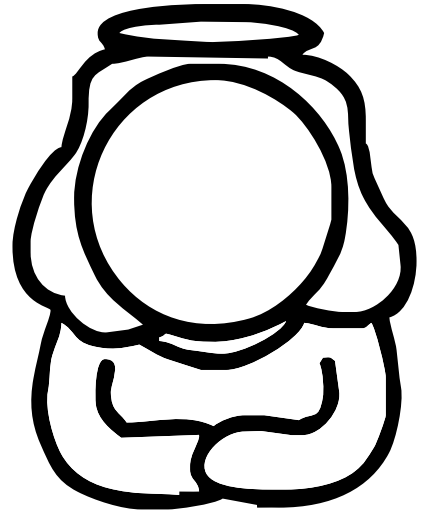

HOMEMADE SUGAR SKULLS

MATERIALS

- 2 cups powdered sugar
- 1 egg white
- 1 tbs. corn syrup
- ½ tsp. vanilla
- 1/3 cup cornstarch
- colored icing
- small clear plastic bags (sandwich size, one for each icing color)
- plastic bowl
- wooden spoon
- scissors



INSTRUCTIONS

1. In the bowl, mix vanilla, egg white, and corn syrup.
2. Add the powdered sugar with the wooden spoon. When the ingredients are almost incorporated, start kneading with the tip of your fingers.
3. Dust your work surface with the cornstarch, and keep kneading until you have a smooth dough.
4. Roll the dough into a ball, and give it a skull shape. Let dry until hard. (This will take about 2-3 days.)
5. Place the colored icing inside the plastic bags, and carefully cut off the tip of a corner, so that when you squeeze the bags, you can use the icing to decorate your skull.

PASTA SKELETON

MATERIALS

- construction paper
- different types of pasta and dried beans
- glue
- skeleton pattern (p. 37)

INSTRUCTIONS

1. Glue the pattern onto the construction paper.
 2. Glue different shapes of pasta on top to form the skeleton.
- * Suggest using spaghetti pieces for fingers and toes, tiny tubes or lentils for vertebrae, macaroni for collar bones, arms and legs, white beans for knees, wrists and ankles, two dried lima beans or big shells for hips.

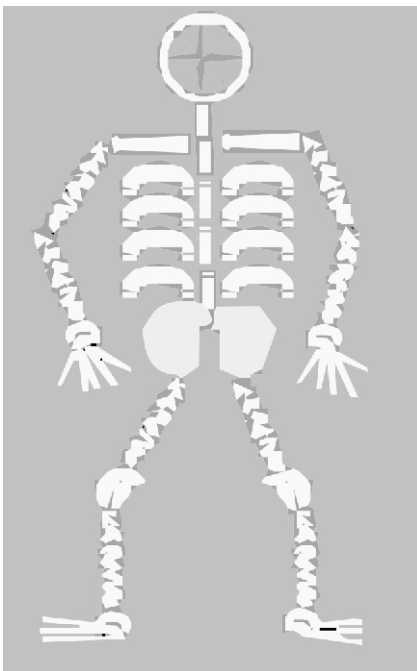

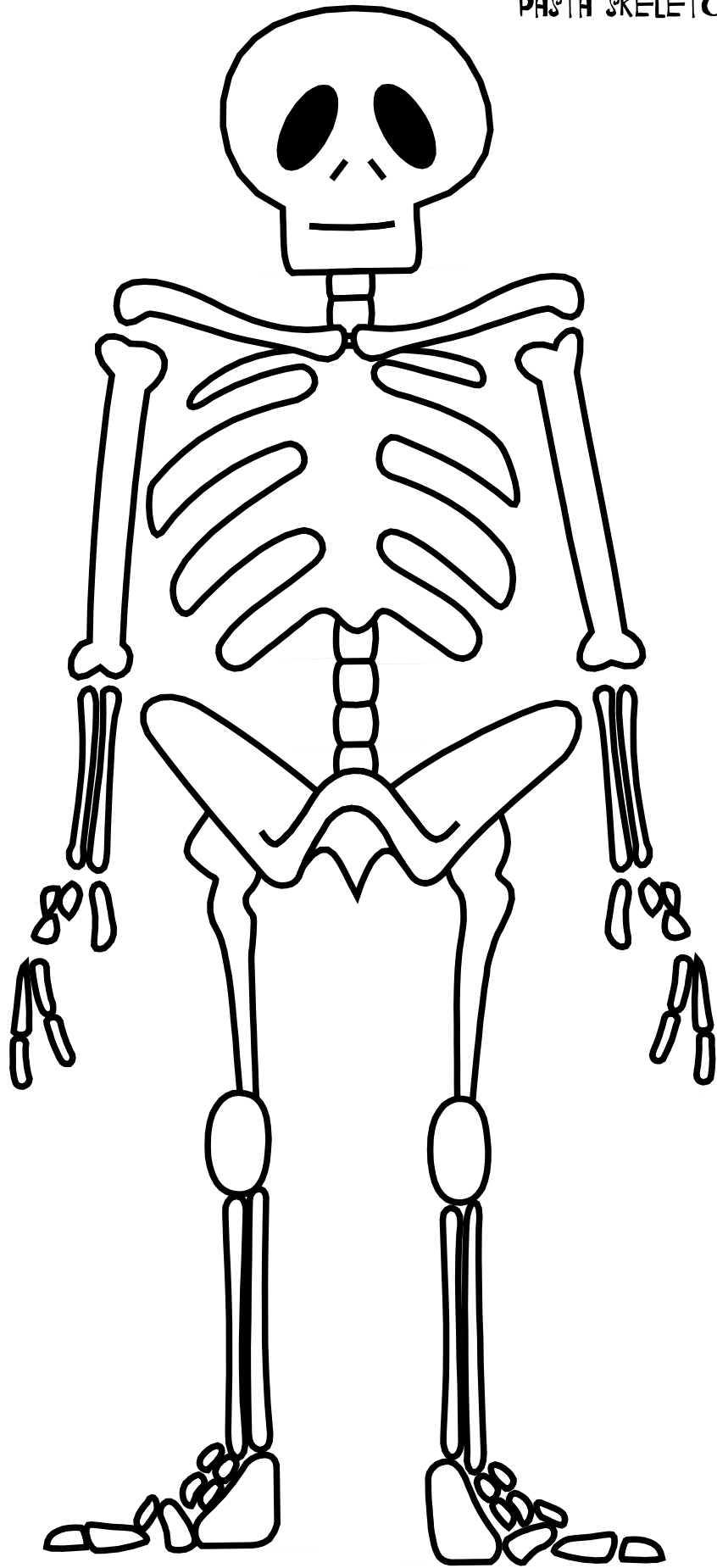

SKELETON PUPPET

MATERIALS

- patterns (pp. 40, 41)
- thin cardboard (folder, cereal box)
- glue and/or tape
- scissors
- needle
- thread



INSTRUCTIONS

1. Glue the patterns onto the cardboard and cut out the pieces along the outline.
2. Make the arm and leg pieces by folding along the grey lines, and gluing the tabs to make rectangle shapes.
3. Fold the hand and feet pieces along the gray line and glue to keep in place. Cut out along the solid black outline of the hands and feet.
4. Glue the hands to the lower arm parts. (see fig. 1)
5. Glue the feet to the lower leg parts. (see fig. 2)
6. Using the needle, run the thread through the white dots at the rounded ends of a piece (ex. upper left ARM) and attach it to its corresponding part (ex. lower left ARM). (see fig. 3) Assemble arms and legs.
7. Make the torso, folding along the grey lines, and gluing the tab.
8. Locate the white dot at the flat end of the upper arms and attach it with the thread to the corresponding side of the torso. (see fig. 4)
9. Attach the legs to their corresponding side at the bottom of the torso. (see fig. 5)
10. Cut along the white dotted lines on the head piece, fold along the gray lines, and glue to make the head shape. (see fig. 6)
11. To make the control handle, fold the pieces along the gray lines and glue

the tabs to make triangle shapes. Glue the dark gray square on the ARM stick to the dark gray square in the handle. Glue the light gray square on the LEG stick to the light gray square in the handle. (see fig. 7)

12. Run a length of thread through both white dots at the top of the head and make a knot. Do not cut the thread. (see fig. 8)

13. Run the thread through the two white dots on the handle, leave thread approx. 20 cms. long, and tie a knot. (see fig. 9) Glue head to torso.

14. Run a new length of thread through the white dot at the knee of the right leg, and through the white dot and the open end of the right side of the LEG stick. Leave thread long enough so that the knee bends a little. (see fig. 10) Repeat with left leg.

15. Run a new length of thread through the white dot on the right "wrist", and through the white dot and open end of the right side of the ARM stick. Leave thread long enough so that the hand hangs at chest level. (see fig. 10) Repeat with left arm.

16. Hold the control handle firmly, and make your skeleton dance!

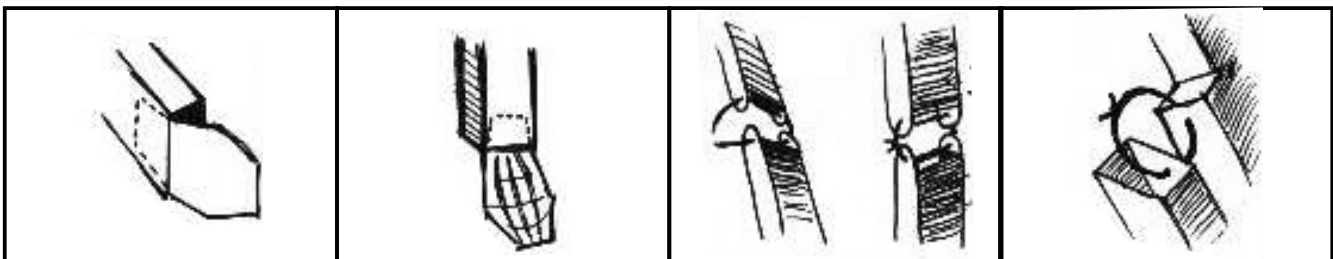

FIG. 1

FIG. 2

FIG. 3

FIG. 4

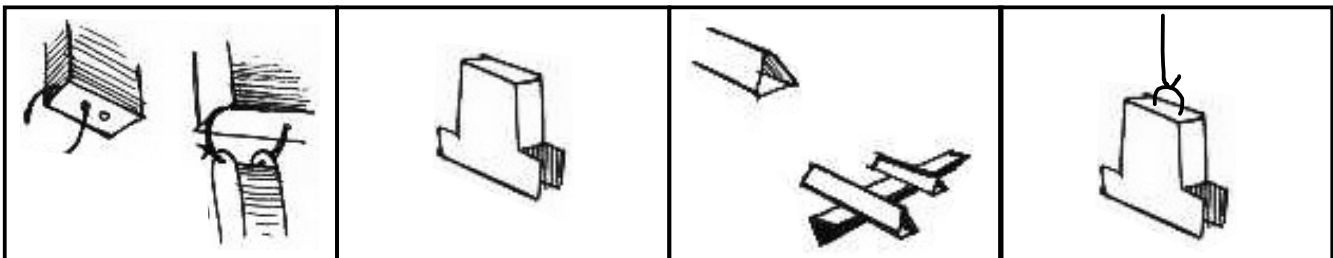

FIG. 5

FIG. 6

FIG. 7

FIG. 8

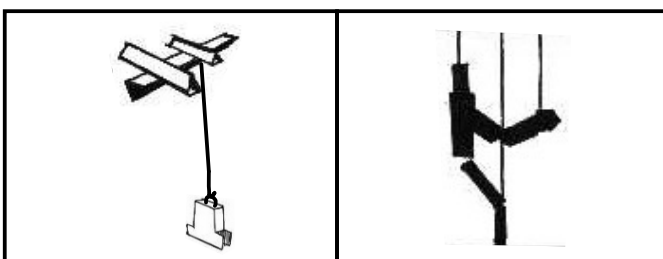
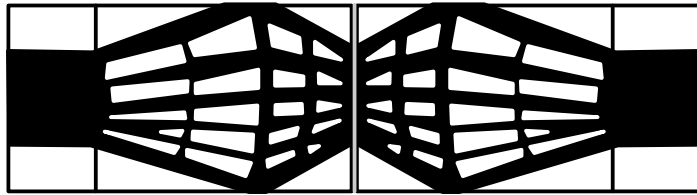
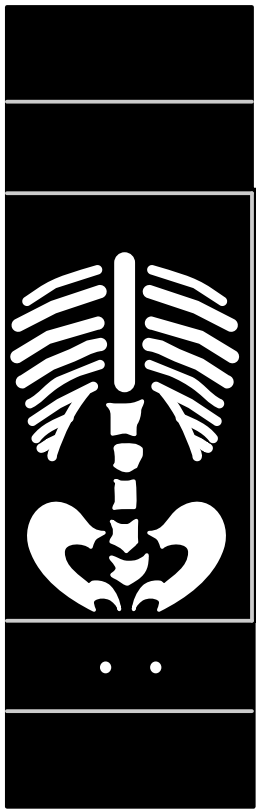

FIG. 9

FIG. 10

SKELETON PUPPET PATTERNS



FEET

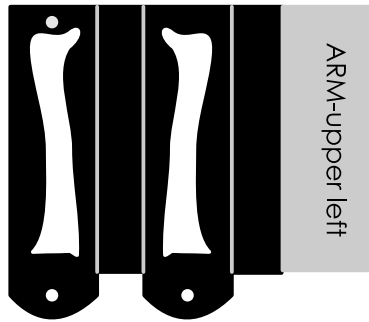
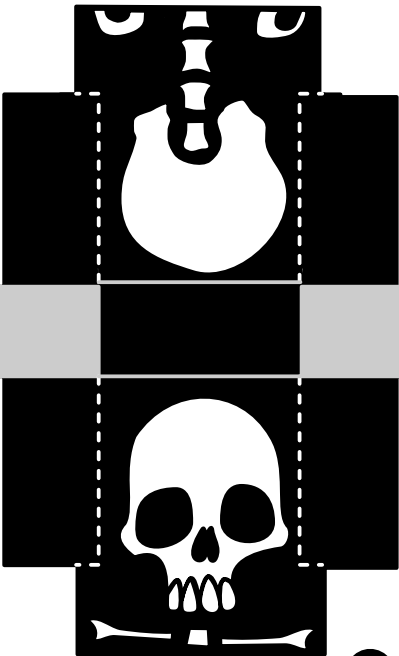
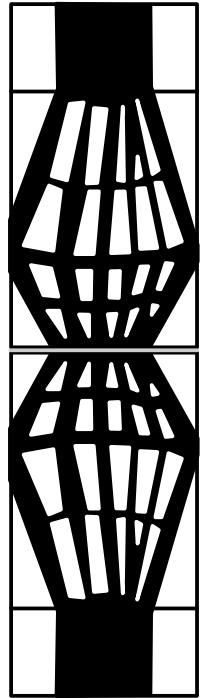

ARM-upper left

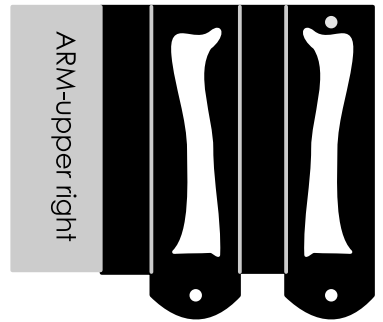

ARM-upper right

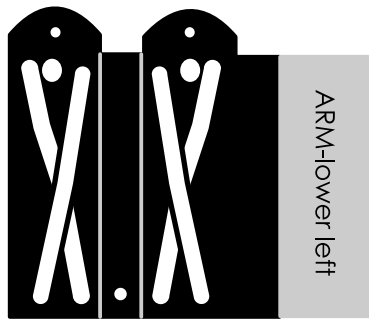

ARM-lower left

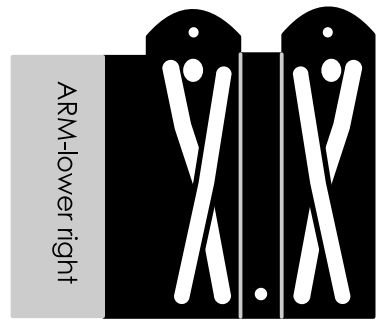

ARM-lower right

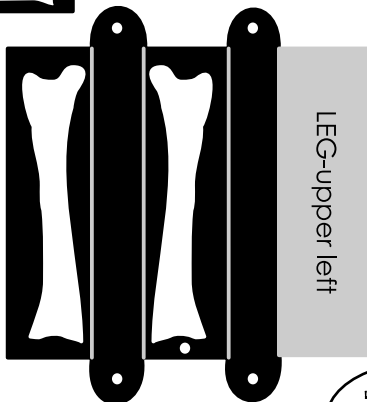

LEG-upper left

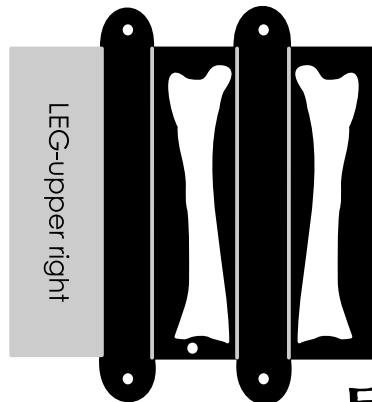

LEG-upper right

SKELETON PUPPET PATTERNS

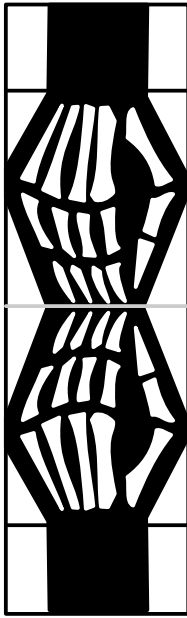

HANDS

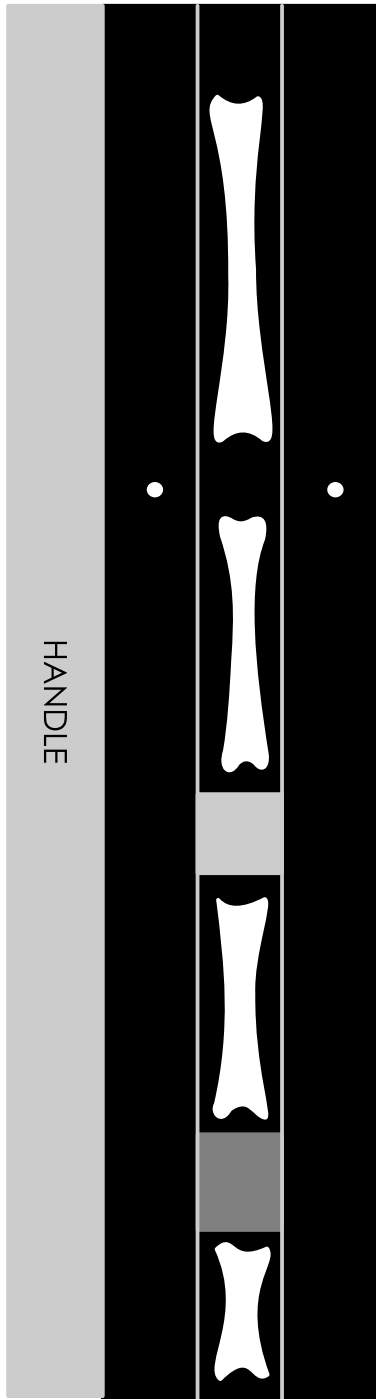
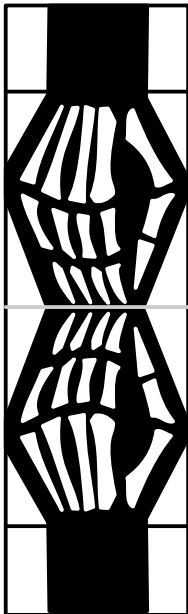

HANDLE

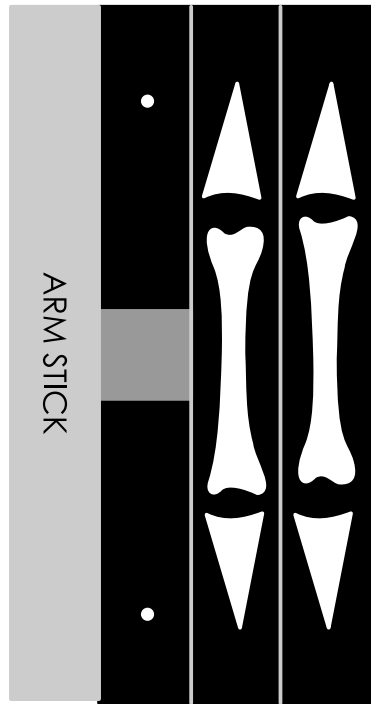

ARM STICK

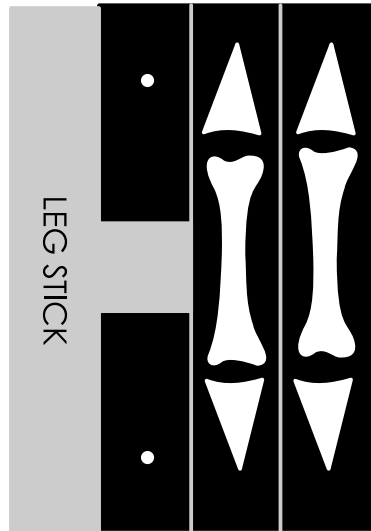

LEG STICK

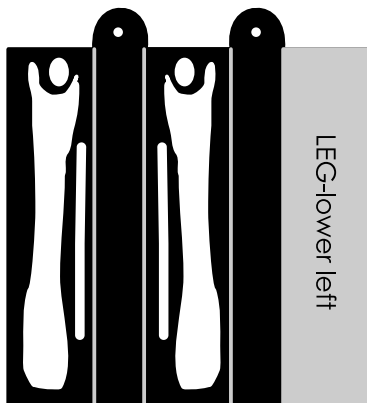

LEG-lower left

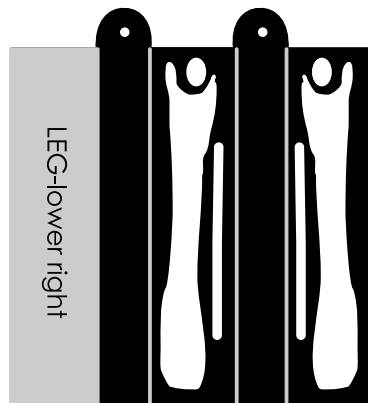

LEG-lower right

GRASS HEAD

MATERIALS

- 1 cup of potting soil
- handful of grass seeds
- cut off leg from a pantyhose
- 2 googly eyes
- markers
- glue/glue gun
- small plate
- water
- optional material: ribbon, hairpins, bows, etc.



INSTRUCTIONS

1. Pour the potting soil into the cut off pantyhose. (see fig. 1)
2. Sprinkle the grass seeds on top of the soil. (see fig. 2)
3. Form into a ball and tie a knot at the top. Use the glue gun and attach the googly eyes. (see fig. 3) Use markers to draw a face and optional material to decorate your grass head.
4. Place the grass head on the small plate and fill it with water. Keep it in a sunny place, making sure it has enough water, and in a week or two your grass head should have a lovely hair style!

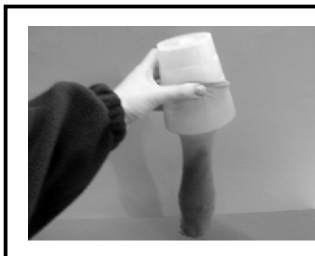

FIG. 1

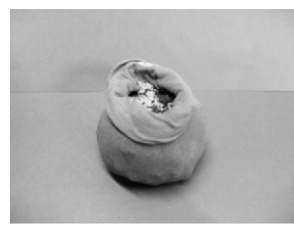

FIG. 2



FIG. 3

MILK CARTON BIRD FEEDER

MATERIALS

- 1 lt. milk carton (clean)
- scissors
- string or yarn
- hole punch
- bird seed



INSTRUCTIONS

1. Carefully cut a hole in the milk carton. (see example)
2. Punch a hole at the top of the milk carton, and tie the string or yarn so that you can hang your bird feeder.
3. Fill the bottom of the milk carton with bird seed. (see example)
4. Hang your bird feeder and watch the birds enjoy their snack!
5. Check your bird feeder regularly and refill it as needed.

* You may choose to decorate the outside of the carton, but keep in mind that it will be outside and decorations may wash off in the rain.

PINECONE PHOTO HOLDER

MATERIALS

- large pinecone
- photograph
- corrugated cardboard (15 x 15 cms.)
- scissors
- glue
- decorating material: twigs, leaves, acorns, rocks, etc.



INSTRUCTIONS

1. Glue the pinecone to the corrugated cardboard.
2. Arrange the decorating material any way you like around the pinecone and glue in place.
3. Cut away any extra cardboard from the base of the picture holder. (see fig. 1)
4. Insert the photograph into the pinecone. (see example)



FIG. 1

TWIG TRIVET

MATERIALS

- twigs
- corrugated cardboard (30 x 30 cms.)
- yute rope (1 mt. approx.)
- scissors
- glue

INSTRUCTIONS

1. Cut the sticks into 15 cm. lengths. Use sticks that are as straight as possible. You will need about 30 pieces. (see fig. 1)
2. Spread glue in a thick layer onto the cardboard square, and arrange the sticks in a parquet pattern. (see fig. 2) Place the sticks as close as possible. Let dry.
3. Apply a thick line of glue around the outside edge of the trivet. Place the yute rope on the glue and press firmly to the edge of the trivet. Overlap the rope ends slightly. Let dry. (see fig. 3)

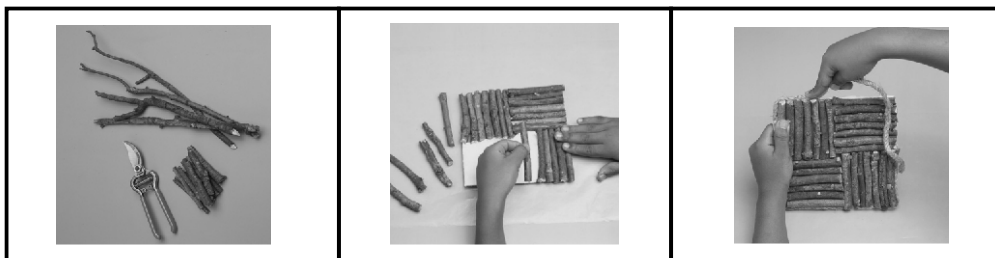

FIG. 1

FIG. 2

FIG. 3

#1 DAD ROSETTE

MATERIALS

- colored cardboard
- crêpe paper
- glue
- scissors
- ribbon
- tape

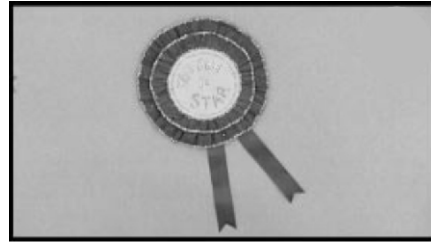

INSTRUCTIONS

1. Cut out two circles of the same size out of the colored cardboard.
2. Cut long strips of crêpe paper, 2.5 cms. wide.
3. Glue as many strips of crêpe paper as you need around the edge of the cardboard circles (see fig. 1).
4. Take two pieces of ribbon of the same length, and snip a triangle shape at one end of both pieces (see fig. 2).
5. Glue or tape the ribbons at a slanted angle to the back of the rosette (see fig. 3).
6. Glue the second circle onto the back and let dry.
7. Decorate the front of the rosette with "#1 Dad" or any other message or drawing you want.



FIGURE 1

FIGURE 2

FIGURE 3

CAR PICTURE FRAME

MATERIALS

- car picture frame patterns (p. 48)
- thin cardboard (folder, cereal box)
- black construction paper (letter size)
- colors, markers, crayons
- pencil
- scissors
- white color or chalk
- glue
- photo of you and your dad

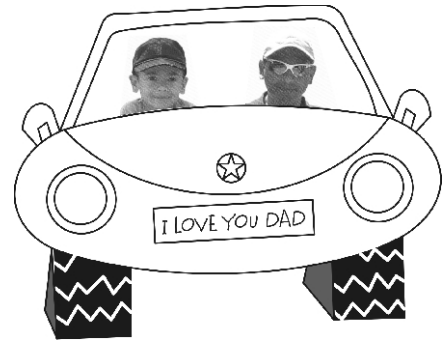

INSTRUCTIONS

1. Glue the car pattern onto the cardboard. Color and cut out.
2. Cut out a photo of you and your dad that fits in the car window. (see fig.1)
3. Glue the photos on the car's window. (see example)
4. Trace the rectangle pattern twice on the black construction paper and cut out. Use the white color or chalk to draw a tire pattern on both rectangles. (see fig.2)
5. Fold both rectangles where indicated, and glue the tabs to make the car's wheels. (see fig.3)
6. Glue the wheels to the back of the car. (see fig.4)

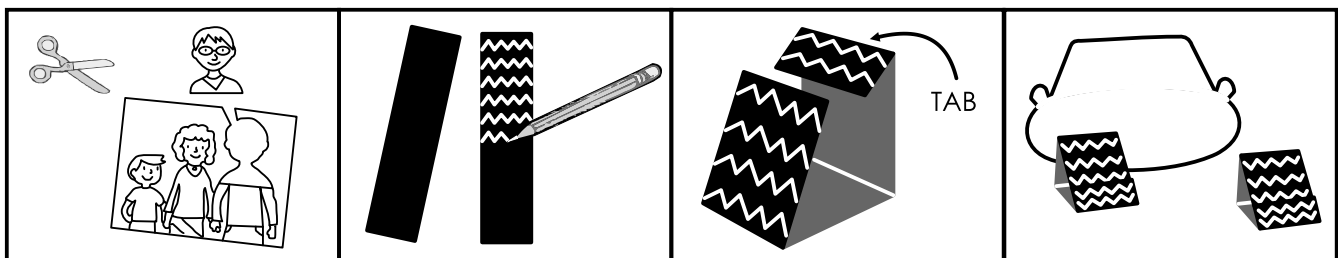

FIG. 1

FIG. 2

FIG. 3

FIG. 4

CAR PICTURE FRAME PATTERNS

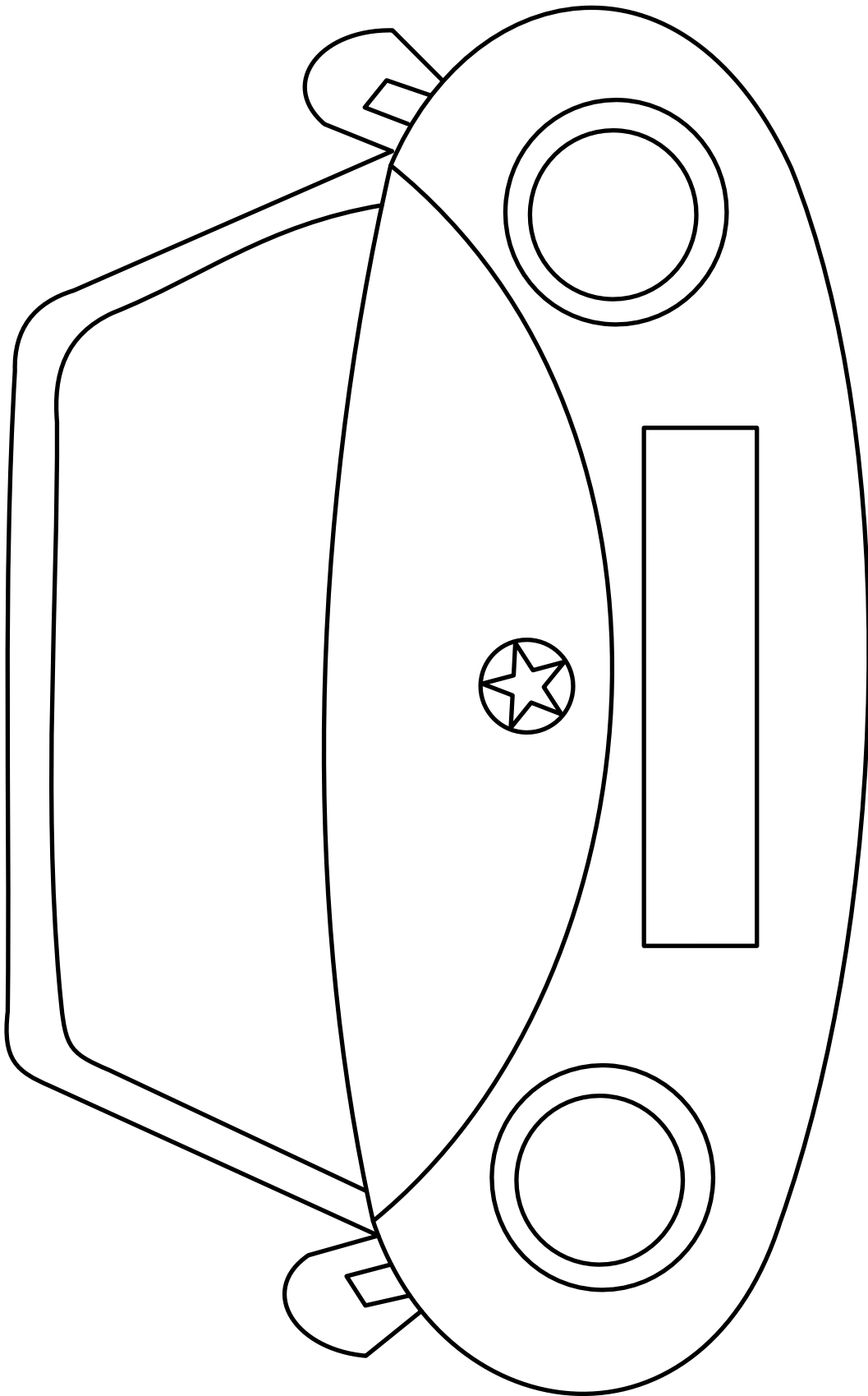

GLUE
FOLD

FOLD

FOLD

FOLD

HANGING DADS

MATERIALS

- construction paper scraps (assorted colors)
- pencil
- colors, crayons, markers
- 30 cms. ribbon
- scissors
- glue and/or tape
- OPTIONAL: decorating material, glitter, sequins, etc.

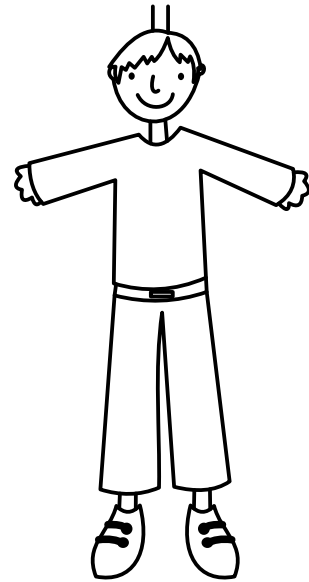

INSTRUCTIONS

1. Draw your dad's head on a piece of construction paper. Color it and cut it out. (see fig. 1)
2. Place the head on a different colored piece of construction paper, and draw a sweater or shirt below it. Cut out. (see fig. 2)
3. Place the sweater or shirt on a different piece of construction paper. Draw jeans or pants and cut out. (see fig. 3)
4. Draw and cut out shoes from another piece of construction paper. (see fig. 4)
5. Glue the jeans to the bottom of the sweater, overlapping a bit. Draw and cut out two hands, and glue them to the back of the arms. (see fig. 5)
6. Glue or tape your dad's body to one end of the piece of ribbon. Glue or tape his head, and attach his shoes with two short pieces of ribbon. (see fig. 6)
7. Use markers and different materials to add details to your dad. (see fig. 7)

* Encourage Ss to be creative, and draw different types of clothes for their dads.

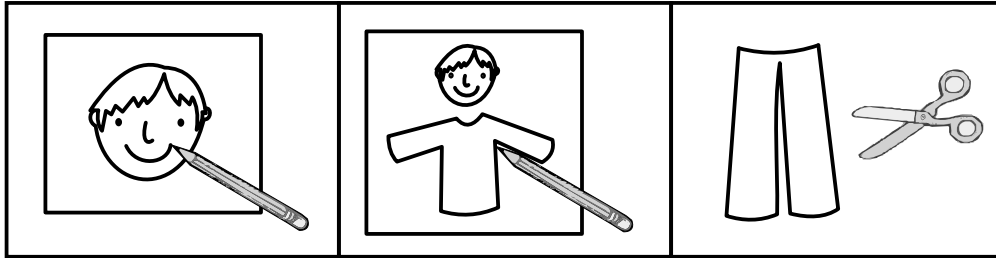

FIG. 1

FIG. 2

FIG. 3

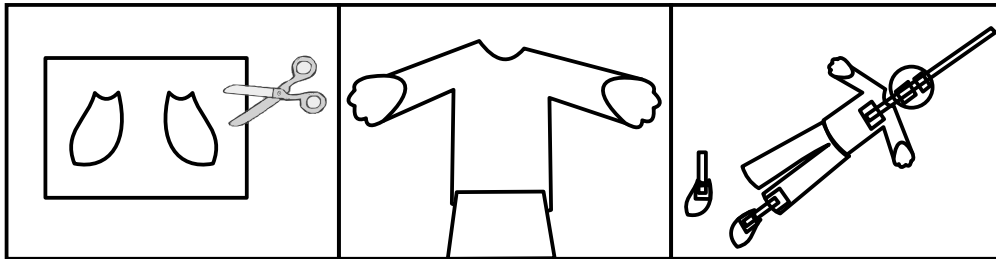

FIG. 4

FIG. 5

FIG. 6

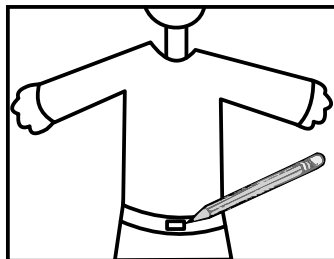
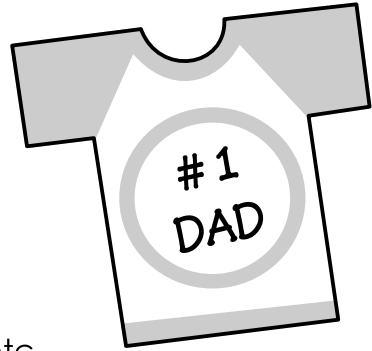

FIG. 7

T-SHIRT CARD

MATERIALS

- white construction paper (letter size)
- pencil
- colors, crayons, markers
- scissors
- T-shirt pattern (p. 52)
- OPTIONAL: decorating material, glitter, sequins, etc.



INSTRUCTIONS

1. Fold the construction paper sheet in half, from top to bottom. (see fig. 1)
2. Trace the T-shirt pattern onto the folded construction paper. Cut out. (see fig. 2)
3. Using your markers, color the T-shirt any way you like. (see example) You can use your optional material to decorate your T-shirt.
4. Write a message for your dad on the inside of the card.

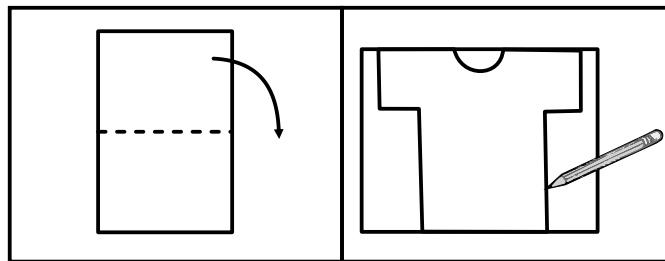
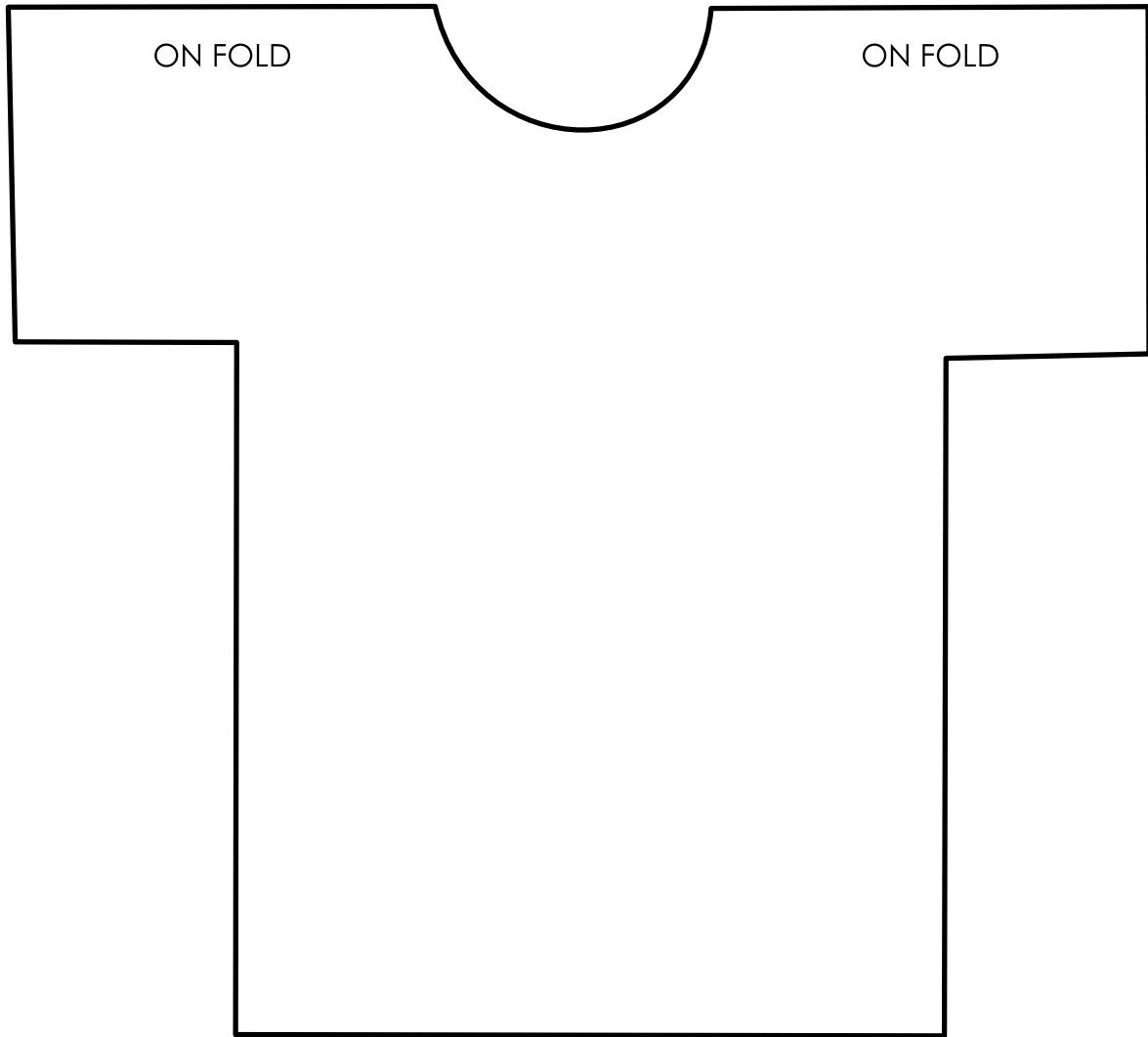

FIG. 1

FIG. 2

T-SHIRT CARD PATTERN



HANGING HAND PLAQUE

MATERIALS

- scissors
- pencil
- glue
- hot glue gun
- paintbrush
- 1 old CD
- paint (any color you like)
- lace ribbon (same color as paint) 5 cms. wide, 45 cms. long, approx.
- red satin ribbon, 5 cms. wide, 45 cms. long approx.
- yellow construction paper (letter size)



INSTRUCTIONS

1. Using the pencil, trace around the CD twice on the yellow construction paper.
2. Cut out both circles.
3. Use the paintbrush to spread glue on one side of the CD and glue one yellow circle on, smooth out.
4. Do the same on the other side of the CD.
5. Paint the palm of your hand and press it carefully to the center of the yellow circle on one side of the CD. Let dry.
6. Hot glue the lace ribbon around the edge of the CD on the back (where there is no print). (see example)
7. Tie the two ends of the red ribbon together, and glue to the back of the CD to hang the plaque.

READY TO BLOOM BOUQUET

MATERIALS

- egg carton cups (as many flowers as you want to make)
- styrofoam eggs (same number as egg carton cups)
- paint (different colors)
- paintbrush
- ribbon
- craft sticks or pipe cleaners (green ones)
- hot glue gun

INSTRUCTIONS

1. Paint the styrofoam eggs any color (s) you want. Let them dry.
2. Paint the egg carton cups green and let dry.
3. Paint the craft sticks green; let dry.
4. Glue the styrofoam eggs into the egg carton cups.
5. Stick the craft sticks or the pipe cleaners at the bottom of the egg carton cups and glue in place.
6. Tie together with the ribbon to make a bouquet (see example).

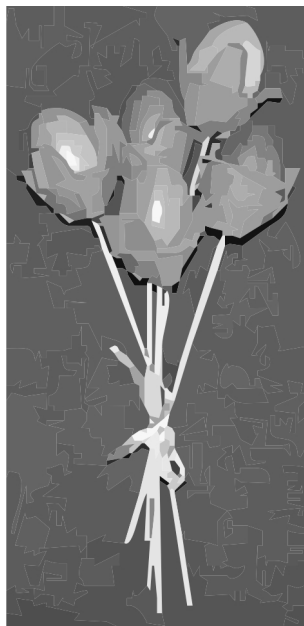

WOVEN YARN BASKET

MATERIALS

- basket pattern (p. 56)
- 1 ball or 10 mts. of yarn (color of your choice)
- 1 foamy sheet (letter size, color of your choice)
- scissors

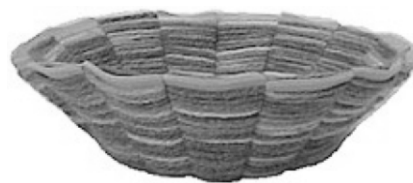

INSTRUCTIONS

1. Cut out the basket pattern and trace it onto the foamy sheet. Cut out.
2. Beginning at the center of the basket pattern, weave the yarn over and under the tabs. (see fig.1)
3. Continue weaving the yarn all around the basket until you only have about 1 cm. of foamy showing. (see fig.2)
4. Tuck the yarn in and cut away any excess foamy. (see fig.3)

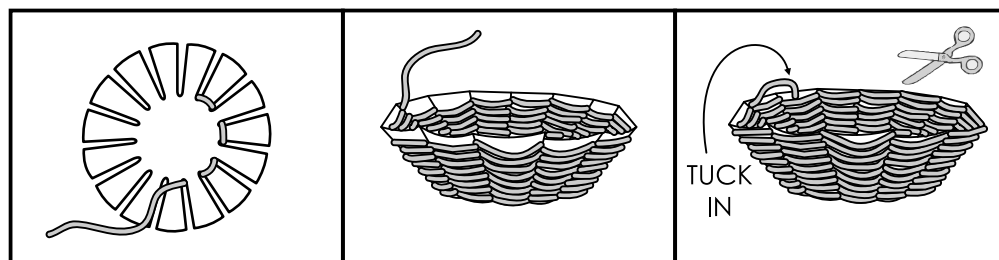
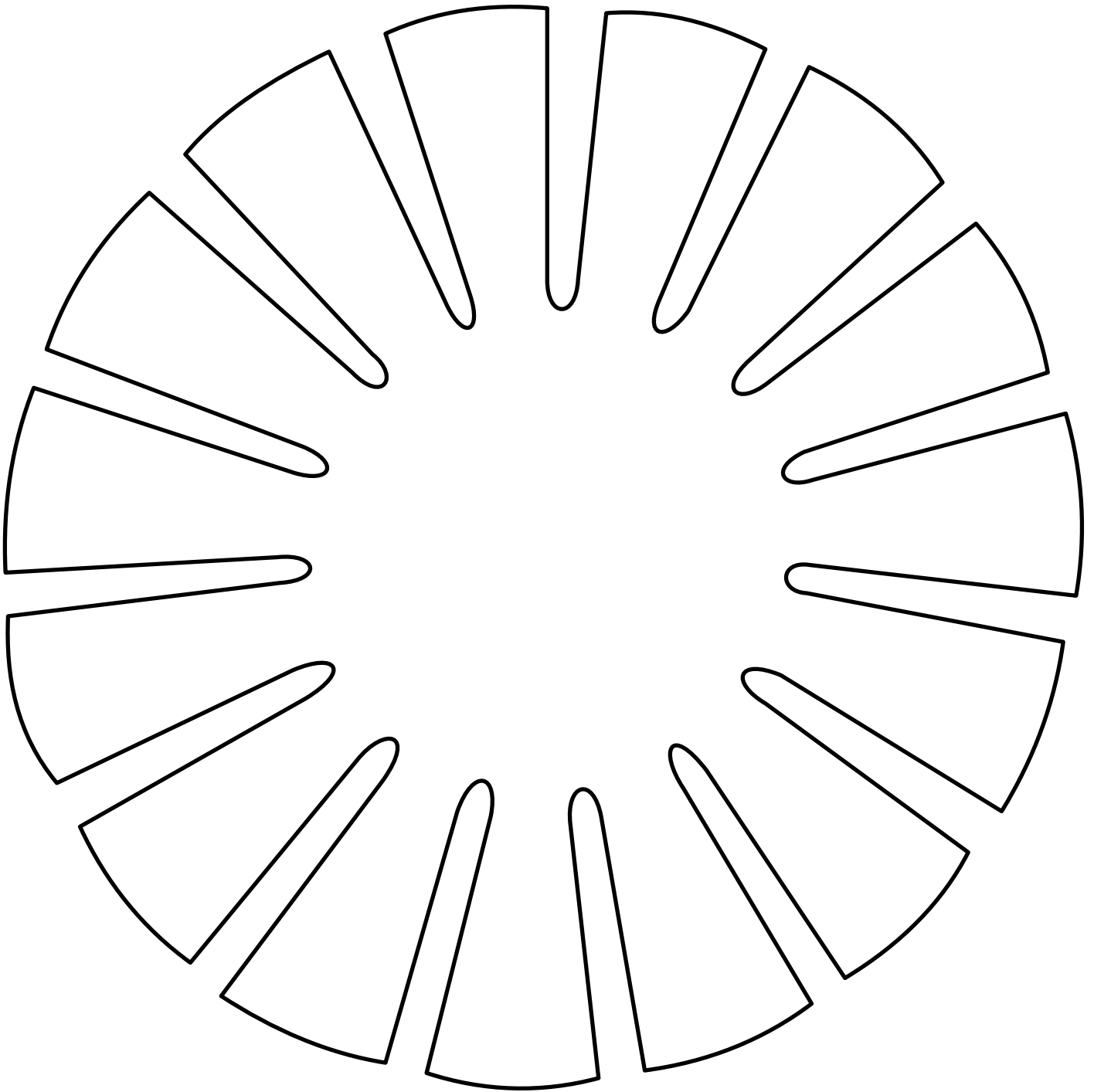

FIG. 1

FIG. 2

FIG. 3

WOVEN YARN BASKET PATTERN



3-D HEART BANNER

MATERIALS

- pattern (p. 58)
- tissue paper (color of your choice)
- pencil
- scissors
- glue

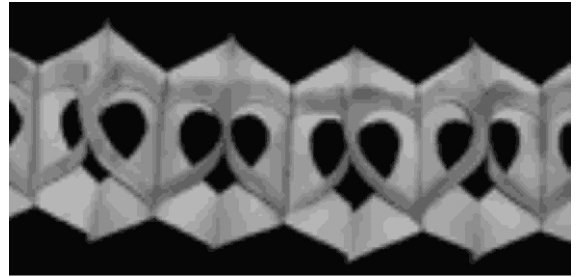

INSTRUCTIONS

1. Trace the pattern onto the tissue paper and cut out. (The more pieces you make, the longer your banner will be.)
2. Glue two pieces together, one on top of the other, at the X's.
3. Glue the next piece on top of the last one, at the O's.
4. Continue gluing pieces alternatively on top of each other (at the X's, at the O's, at the X's, etc.) until you run out of pieces. Let dry.
5. Gently pull apart to reveal your banner.

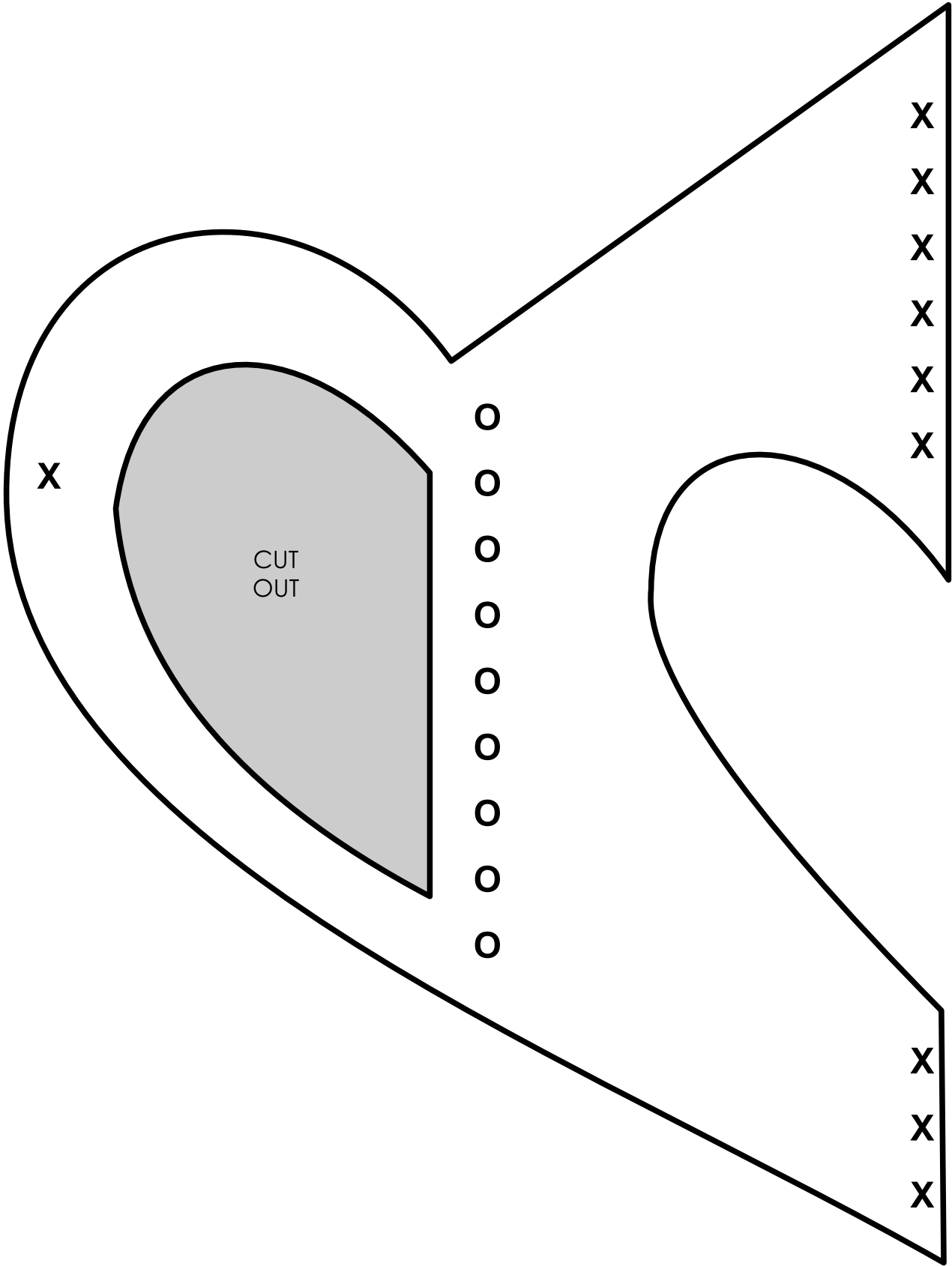

CHOCOLATE MICE

MATERIALS

- chocolate kisses (cut off the paper strip)
- pipe cleaners (red, pink or white)
- mini googly eyes
- mini pom-poms
- yarn
- thread
- scissors
- glue



INSTRUCTIONS

* Each mouse requires one chocolate kiss and one half pipe cleaner.

1. Make a loop with the pipe cleaner and twist the ends to make the feet. Then bend the loop into a heart shape. (see fig. 1)
2. Glue the chocolate kiss to the feet. (see fig. 2)
3. Cut a small piece of yarn, and glue it on as a tail. (see fig. 3)
4. Cut three pieces of thread, and tie a knot in the middle. Glue them on as whiskers. (see fig. 3)
5. Glue the googly eyes and the mini pom-pom as a nose. (see example)

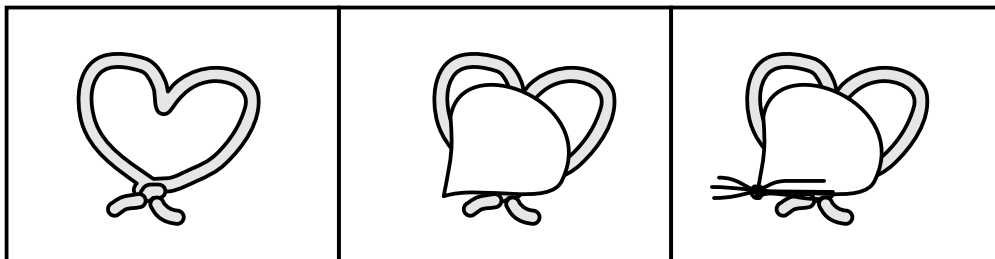

FIG. 1

FIG. 2

FIG. 3

FUN HEARTS BRACELET

MATERIALS

- red foamy (letter size)
- white lace ribbon (2 cms. wide, 40 cms. long)
- heart shaped cutouts (cardboard, greeting card, a different colored foamy, etc.)
- glue or hot glue gun

INSTRUCTIONS

1. Cut out a strip of foamy 30 cms. long x 4 cms. wide. Measure this strip around the wrist of the person who will wear the bracelet and cut off the excess.
 2. Place the piece of lace ribbon centered on the foamy strip and glue in place.
 3. Arrange the heart cutouts on the bracelet until you like the way it looks and glue them in place.
- * Let the glue dry completely before you wear the bracelet.



POPCORN WREATH

MATERIALS

- small styrofoam heart wreath
- popped popcorn
- red foamy
- ribbon or raffia
- scissors
- glue

INSTRUCTIONS

1. Cover the inside of the wreath with glue and allow it to dry until it's just tacky.
2. Cover the inside of the wreath with popcorn.
3. Repeat this procedure with all the parts of the wreath (front, back and outer edge) until it's completely covered with popcorn.
4. Draw a heart shape onto the foamy and cut out.
5. Make a bow with the ribbon or raffia.
6. Glue the bow onto the wreath.
7. Glue the heart onto the bow (see example).

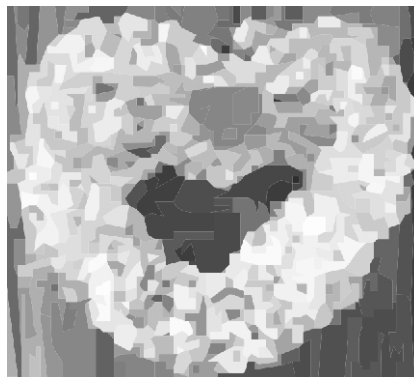

TISSUE PAPER HEART

MATERIALS

- construction paper or cardboard
- colors, crayons, markers
- glue
- scissors
- colored tissue paper
- pencil

INSTRUCTIONS

1. Cut tissue paper into 2.5 cms. X 2.5 cms. squares.
 2. Draw a heart shape on the construction paper and cut it out if you like.
 3. Place the pencil in the center of a tissue paper square.
 4. Wrap the tissue paper around the pencil and allow it to wrinkle.
 5. Put some glue on the end of the tissue paper (still on the pencil) and press it on to the construction paper.
 6. Fill in the heart shape with tissue paper or decorate as you want (see example).
- * If students want to add a drawing or a written message, they should do it before they start gluing the tissue paper.

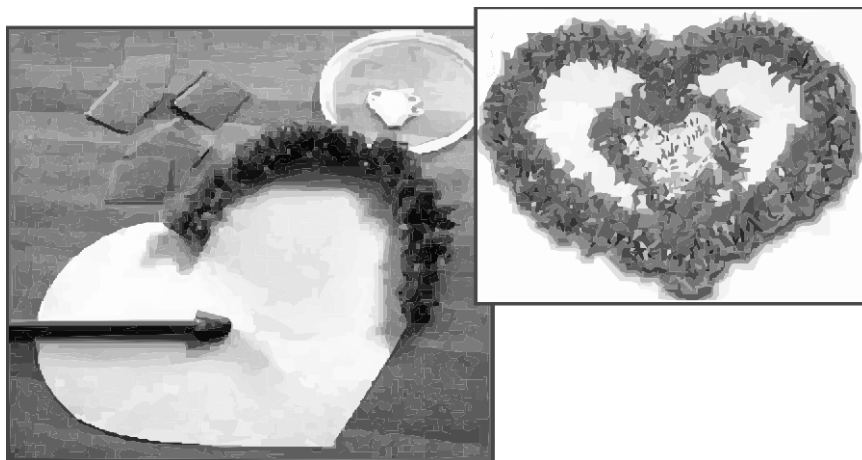

GAMES

BASKETBALL TOSS

MATERIALS

- 1 egg carton cup
- paint: white, red, orange
- 45 cms. wooden dowel (craft stick)
- 2.5 cms. styrofoam ball
- 1 large thumbtack
- 50 cms. string or yarn
- scissors
- paintbrush
- black fine-point permanent marker
- glue



INSTRUCTIONS

1. Cut an egg cup from one of the corners of the carton, making sure to include the tall edge that separates the cups. This becomes the back of the basket. Neatly trim the remaining edges, and paint the basket white. Let dry.
2. Use permanent marker to draw cross-hatched diagonal lines to look like netting.
3. Paint the dowel red and the styrofoam ball orange; let dry. Draw black basketball lines on the ball using permanent marker. Set aside.
4. Push a thumbtack through the tall edge of the basket from the inside out. Run a 1-inch-long line of glue at the top of the dowel. With the tall edge of the egg cup aligned with the top of the dowel, press the cup onto the glue, pushing the tack into the dowel. (see fig. 1)
5. Tie one end of the string to the ball, and the other end below the basket. (see example)

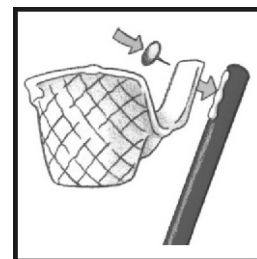

FIGURE 1

BUTTON FLIP GAME

MATERIALS

- egg carton tray
- black paint
- colored paper: 3 colors
- scissors
- paintbrush
- pencil
- black marker
- glue
- point marker pattern (p. 67)
- several buttons (1 and 3/4 inches)



INSTRUCTIONS

1. Cut behind the cone-shaped dividers, leaving them and one row of cups intact. Trim the rough edges behind the cones. (see example)
2. Paint the carton black. Let dry.
3. Cut out and trace the point marker pattern onto each colored paper twice. Outline with black marker, and cut out. Write a number, 10, 20, 30, 40, 50, or 60, on each marker.
4. Bend the top of the marker back, and glue the long end of each behind an egg cup.
5. To play this game, you'll need a few flat 3/4-inch buttons and a 1-inch flat button to use as a shooter. Place the game on a table or the floor. Place a piece of tape several inches in front of the game.
6. With the small buttons anywhere behind the tape, use the shooter button to flip them into the egg cups. Take note of your points as you go.

POINT MARKER PATTERN

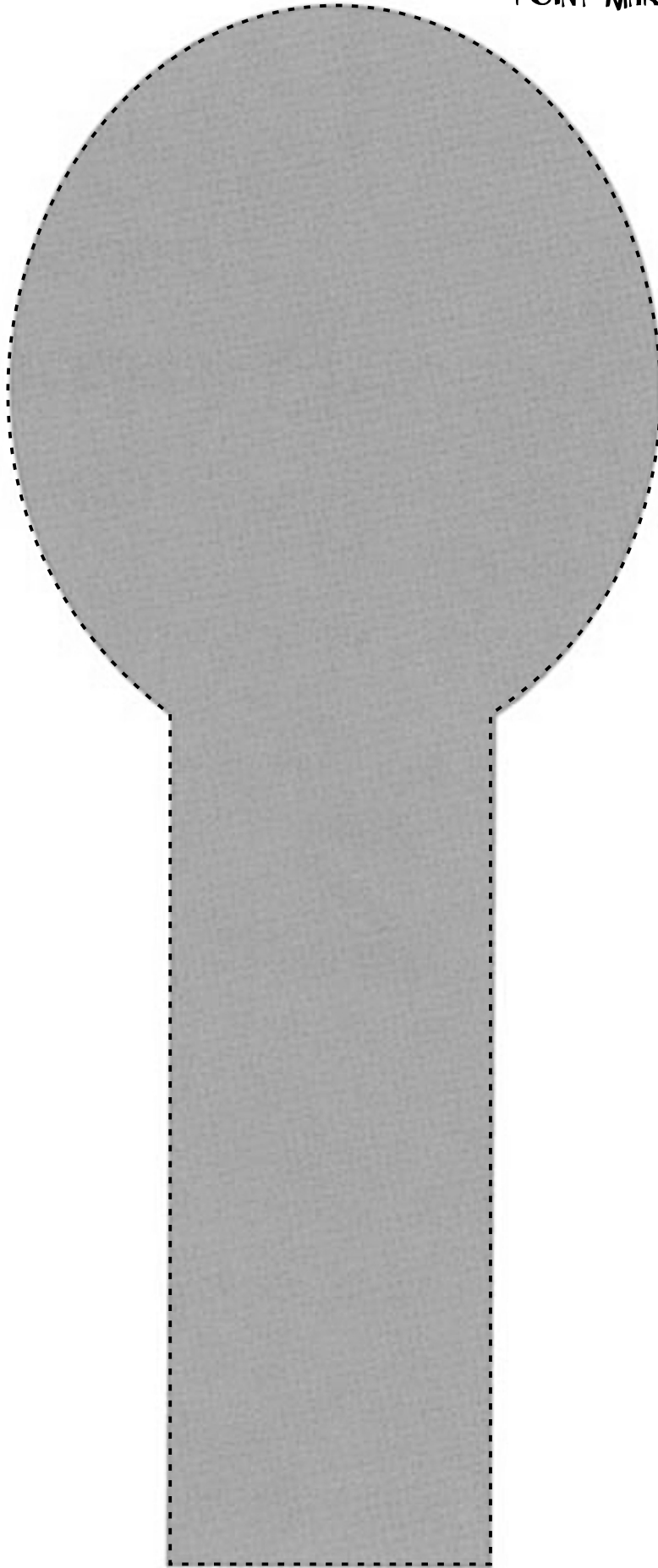

CHILDREN'S HORSESHOES

MATERIALS

- popsicle sticks
- glue
- 2 plastic soda or water bottles (with lids)
- sand or water
- score sheet

INSTRUCTIONS

1. Lay out and glue the popsicle sticks into a U shape. Make sure the edges are overlapping to form the horseshoe shape. Make four. Let dry.
2. Optional: decorate your horseshoes.
3. Fill the plastic bottles with sand or water to help stabilize them.
4. Use the score card to keep track of the score.
 - + 5 points for a popsicle horseshoe that rings the bottle.
 - + 3 points for any popsicle horseshoe that is touching the bottle.
 - + 1 point for any popsicle horseshoe.(Make sure you set a point limit from the start so that you will know who wins.)
5. Go outside and place your bottles about 3 mts. apart.
6. Take turns throwing your popsicle horseshoes at the bottles.

CRAFT STICK PUZZLE

MATERIALS

- 7 jumbo craft sticks
- pictures from a storybook or magazine
- masking tape
- scissors
- glue
- craft knife (adult assistance)

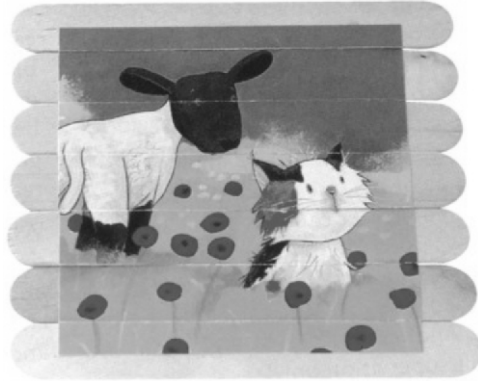

INSTRUCTIONS

1. Line up 7 jumbo craft sticks side by side on your work surface, and tape them together to hold them in place while you work. Turn the sticks over.
2. Trim a picture to fit on the craft sticks, and glue it to the center of the sticks. Let the glue dry, and then remove the tape from the back of the sticks.
3. Ask a grown-up to cut the sticks apart by running a craft knife through the seams where the sticks meet.



FOOD MEMORY GAME

MATERIALS

- thin cardboard (folder, cereal box)
- patterns (pp. 71, 72)
- glue
- scissors
- OPTIONAL: pencil and colors or crayons if you are using the blank pattern

INSTRUCTIONS

1. Glue the memory game pattern onto the thin cardboard.
2. Cut out the cards and play!

* If you are using the blank pattern, make sure to draw your images twice, so that they will match. Color your drawings, and follow steps 1 and 2. *

FOOD MEMORY GAME PATTERN

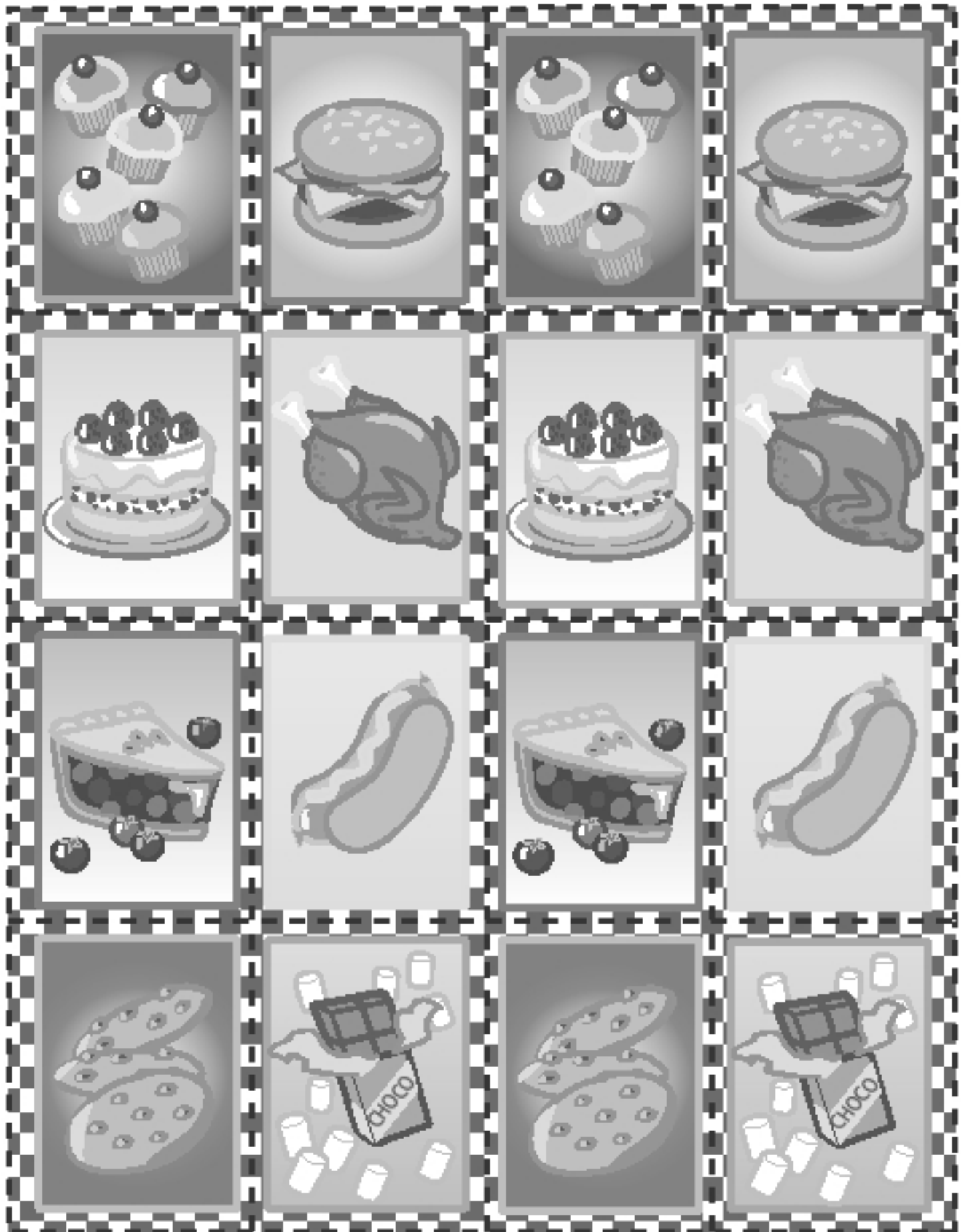

MEMORY GAME PATTERN

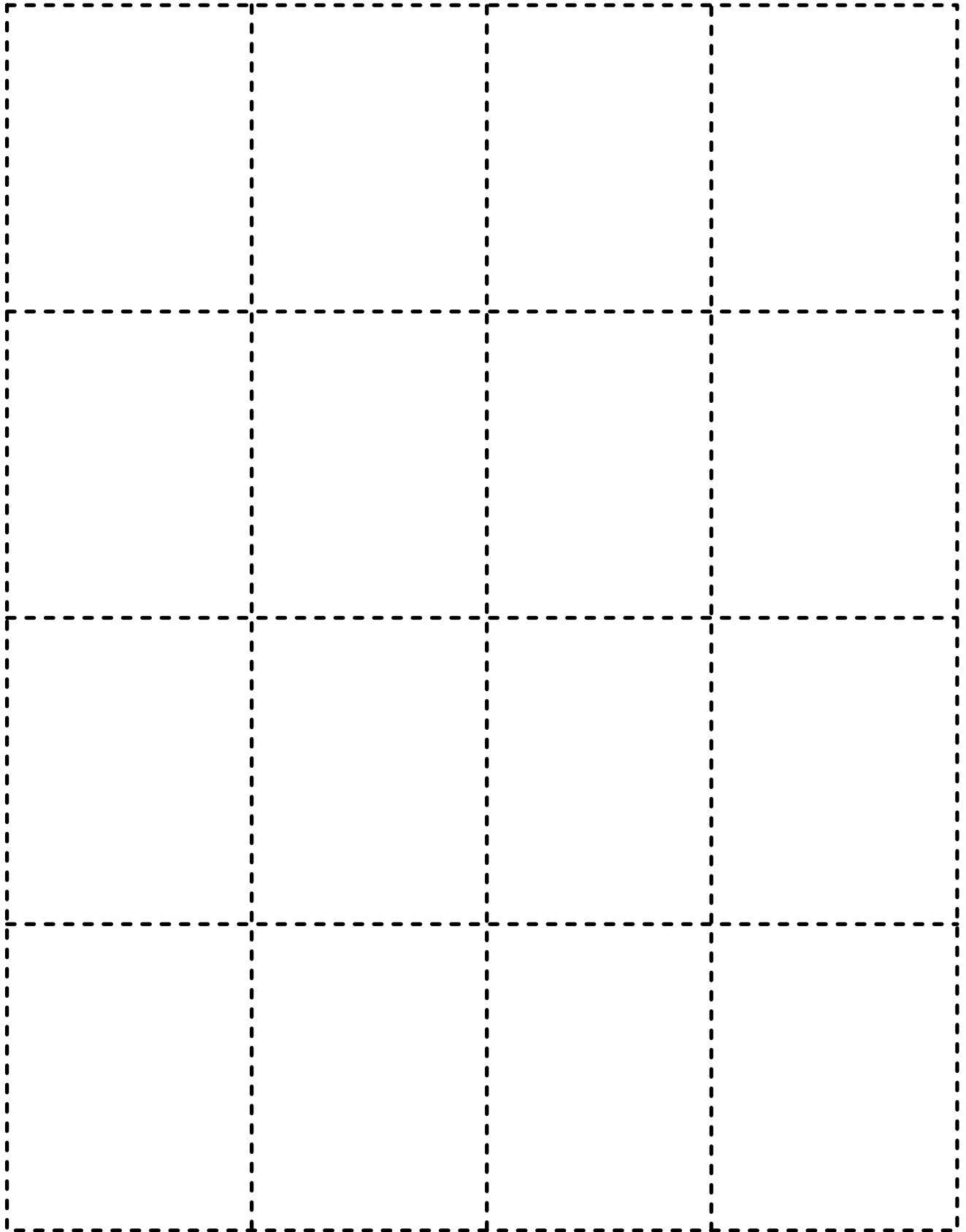

FRISBEE

MATERIALS

- 2 plastic plates
- scissors
- 1 large clear plastic bag
- glitter/sequins
- stapler

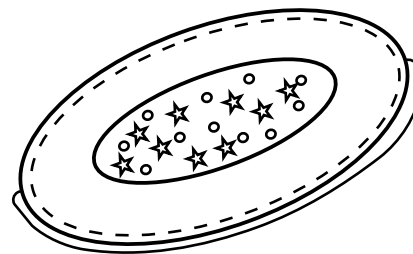

INSTRUCTIONS

1. Cut out the center of the two plates, leaving the rim intact.
2. Place the glitter/sequins in the plastic bag and close.
3. Place the plastic bag filled with glitter between the two plates. Staple the plates together around the edges.
4. Cut off any plastic that hangs out of the edge of the plates.

GO DINOSAUR GO!

MATERIALS

- pattern (p. 75)
- thin cardboard (folder, cereal box)
- glue
- scissors
- coins, buttons (to use as game markers)
- a die

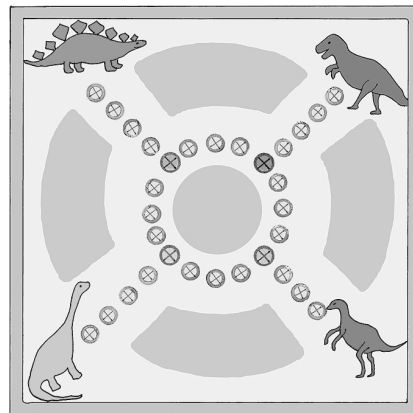

INSTRUCTIONS

1. Glue game pattern onto the thin cardboard and cut out.
2. Use a coin or button as game marker.
3. Place game marker on chosen dinosaur. Roll the die to see who goes first. Highest roll begins. Player 1 rolls the die and moves the corresponding number of spaces. Each player **must** go around the circle one full circle before trying to get back to their dinosaur. Player must land exactly in their home circle (the one that is the same color as their dinosaur) to be able to get to the dinosaur. Player can go back and forth in front of the home circle until he lands on it. Player who gets to his dinosaur first wins.

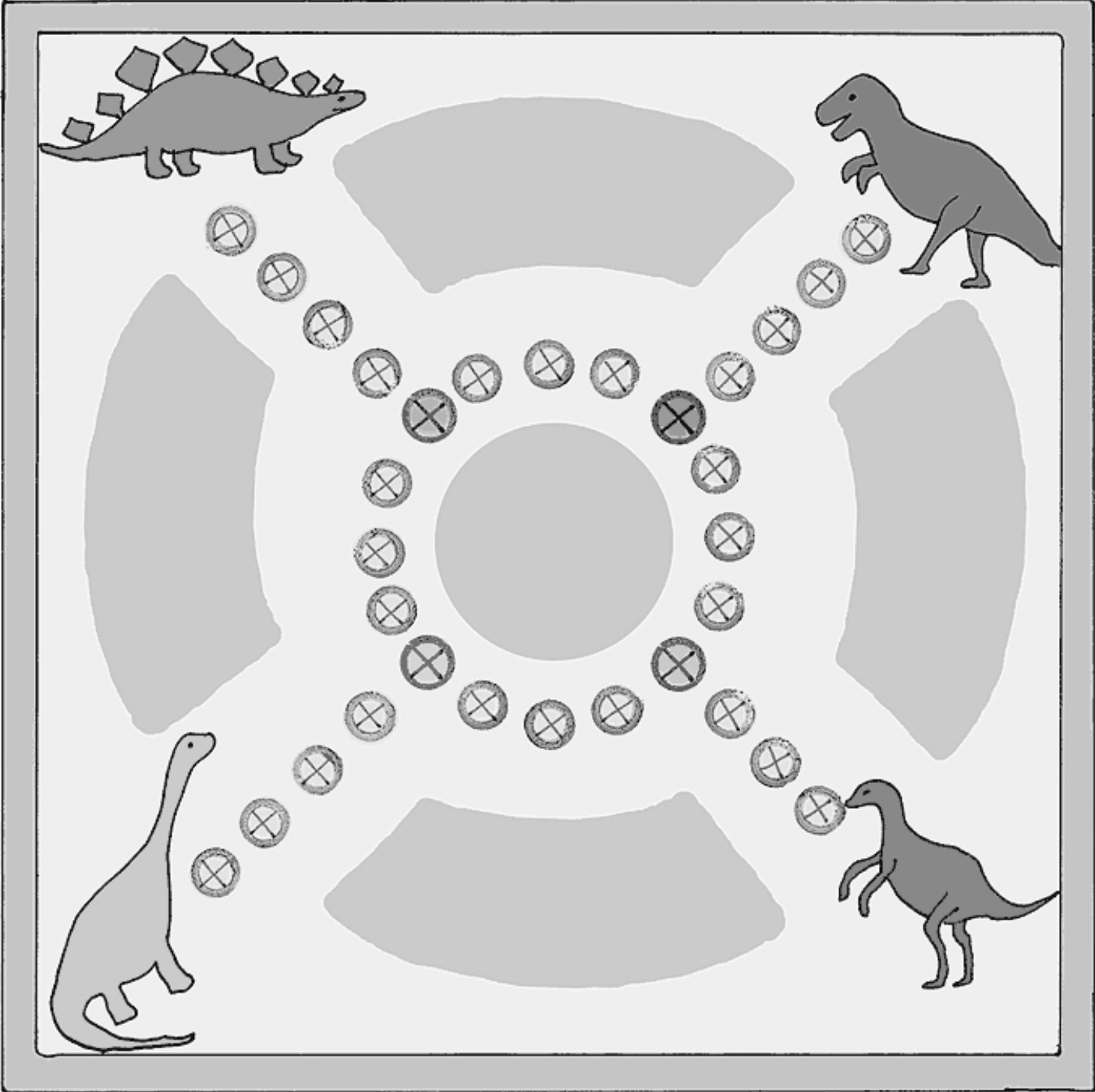

GO FISH

MATERIALS

- fish patterns (p. 77)
- colors, crayons, markers
- scissors
- hole punch
- craft stick
- 1 paper clip
- string or yarn
- cardboard (folder, cereal box)
- glue

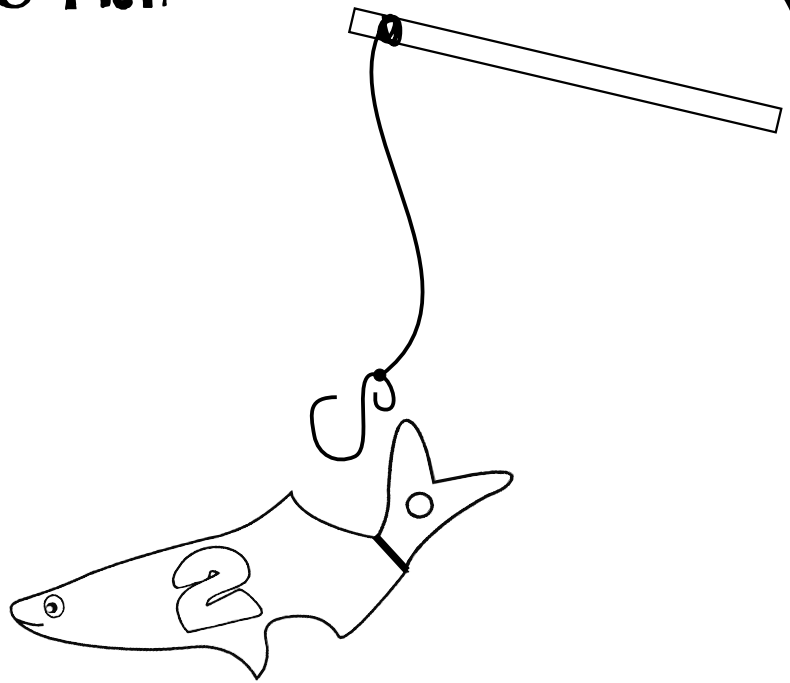

INSTRUCTIONS

1. Each child should have at least 2 sets of fish patterns
2. Color and decorate the fish patterns.
3. Glue onto the cardboard and cut out the fishes.
4. Fold the fishes' tail upward and punch a hole at the hole mark.
5. Unfold the paper clip to make a fishing hook. (see fig. 1)
6. Tie the end of a 60 cm. yarn piece to your hook.
7. Tie the other end of the yarn to the craft stick to make a fishing rod. Go fishing.
8. The player who adds up the most points wins.

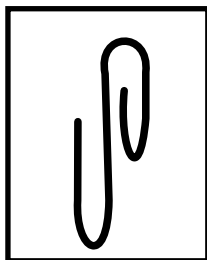
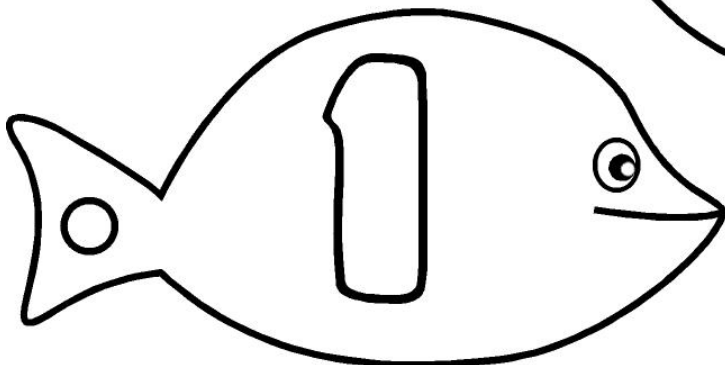
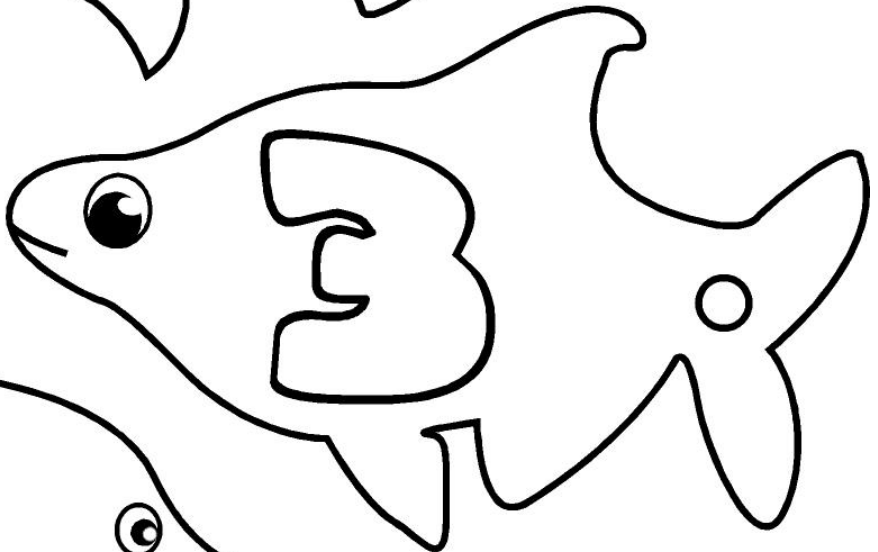
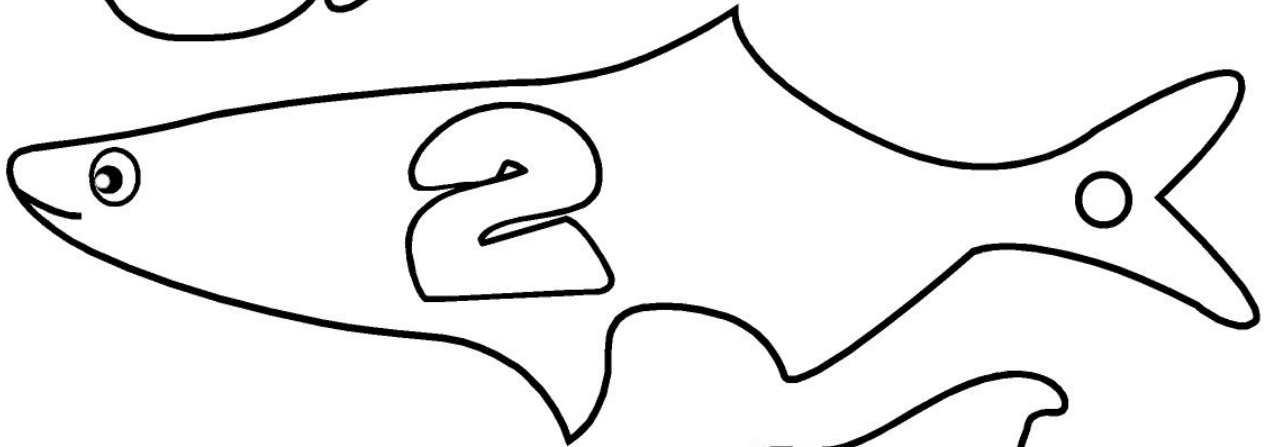
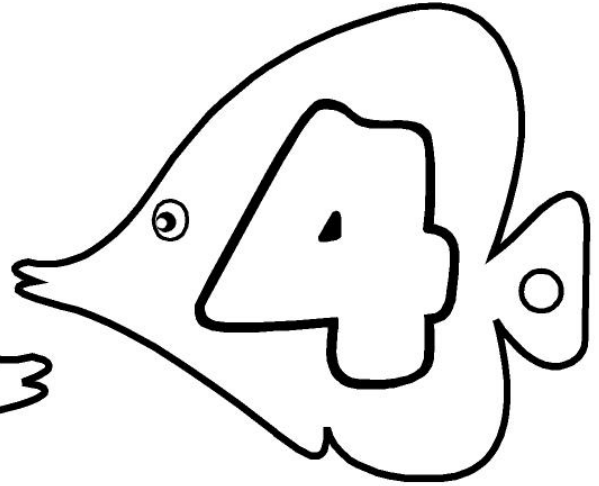
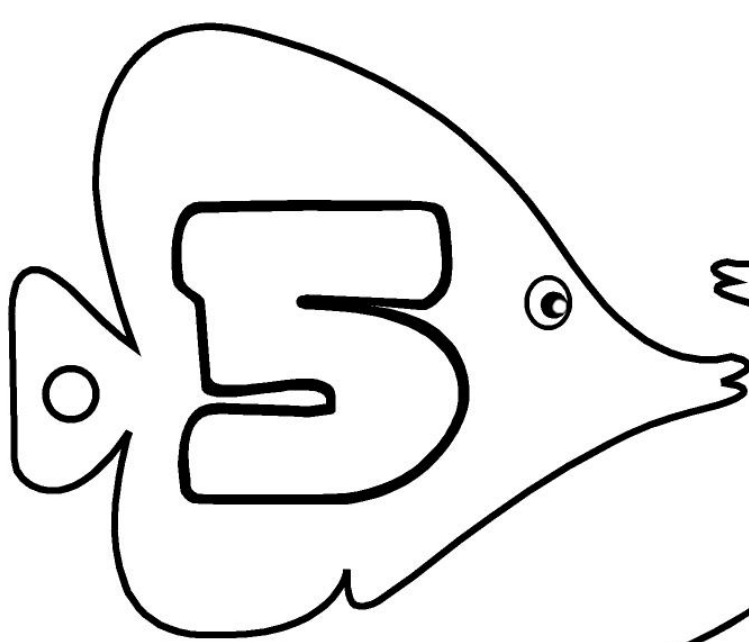

FIGURE 1



MATH TOSSES MADNESS

MATERIALS

- toss diagram (p. 79)
- score sheet (p. 80)
- chalk
- small rocks
- pencil or pen

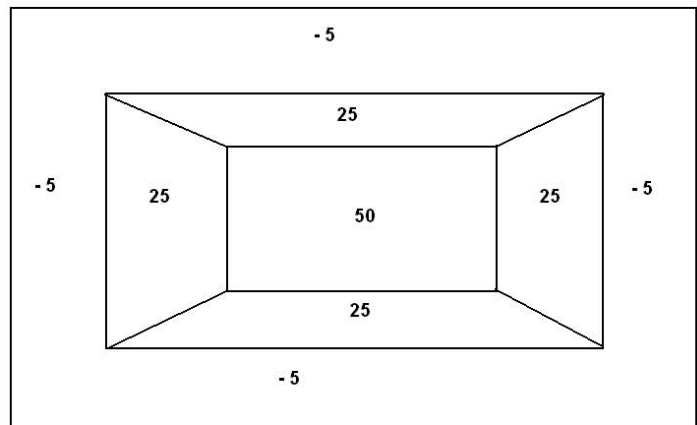

INSTRUCTIONS

1. Draw the toss diagram with the chalk on the ground.
2. Stand at least 1 m. back from the edge of the outer square to toss your rock.
3. Set the number of points you are going to play before the game starts so you know who wins. Keep note of the score on the score sheet.

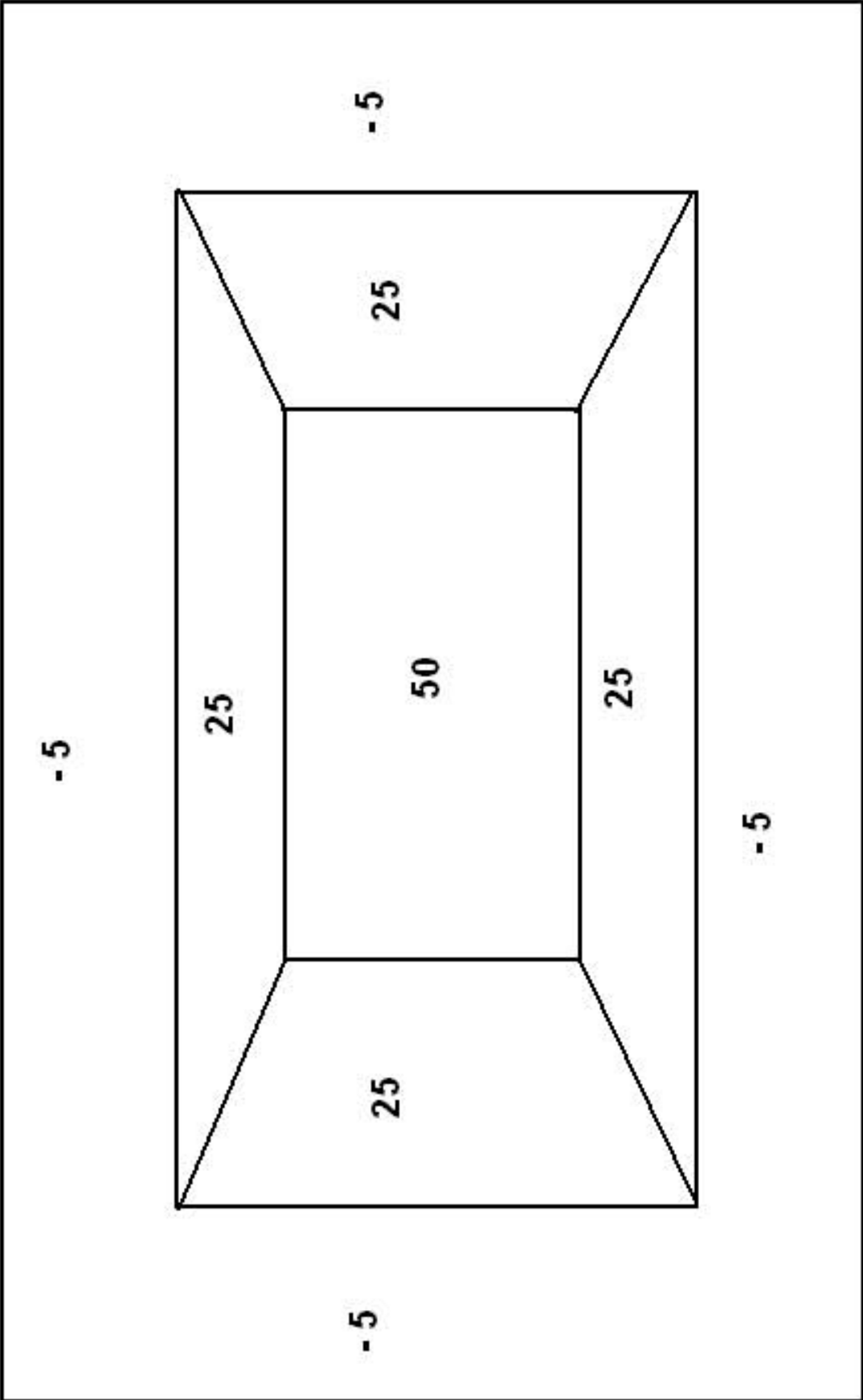

SCORE SHEET

| Player | Player | Player | Player | Player |
|--------|--------|--------|--------|--------|
| | | | | |

POM-POM BASKETBALL

MATERIALS

- 2 empty cereal boxes of the same size
- solid-color gift wrap
- 5 paper cups, 2 ounces each
- white construction paper
- white twist tie
- 1-inch pom-pom
- 30 inches heavy thread
- plastic spoon
- scissors
- tape
- pencil
- craft knife (adult help needed)
- markers
- glue
- ruler
- yarning needle
- duct tape
- masking tape
- backboard pattern (p. 83)



INSTRUCTIONS

1. Open the tops of two cereal boxes, lifting the flaps up. Wrap the bottom and sides of both boxes with gift wrap, leaving the flaps open and unwrapped.
2. Trace the top of a 2-ounce cup four times on the front side of one of the boxes. Turn the cup over, and trace the bottom inside each of the larger circles. (see fig. 1)

3. Ask a grown-up to cut out each of the inner circles using a craft knife. Use scissors to cut tabs from the inside to the outer circle all the way around. (see fig. 1) Bend these tabs down into the box, and insert a cup into each hole. Assign each cup a point value by writing a number on a scrap of paper and gluing it beside each cup.
4. Cut a piece of white paper to fit around the fifth cup, wrap it around, and glue in place. Use red marker to draw diagonal lines that look like netting. With a pencil, make 2 small marks about 1/2 inch apart near the top of the cup. Ask a grown-up to help you poke a hole at each mark.
5. Trace and cut out the backboard pattern from white paper. Outline it in blue, and draw a red square in the center. Glue the backboard onto the front of the second box, near the top (with the arch toward the top). With a pencil, make 2 small marks about 1/2 inch apart near the bottom of the backboard, and ask a grown-up to poke a hole at each mark.
6. Insert a twist tie through the holes in the cup and through the holes in the backboard. Reach into the open end of the box, and twist the tie to secure the cup. Mark a point value just below the cup. (see fig. 2)
7. Thread the pom-pom onto a 30-inch length of heavy thread, and knot it in place at the end. Tie the other end of the thread to the head of a plastic spoon.
8. Ask a grown-up to cut a 1-inch slit in the box with the cups (see example), cutting through both flaps in the same place. Insert the plastic spoon handle into this slit, and use duct tape to secure the handle of the spoon to the inside of the box.
9. Tape the open flaps of both boxes closed, and tape the boxes together into an L-shape with the cups at the base and the backboard standing up.
10. Play Ball! Place the pom-pom in the spoon. Push down on the tip of spoon with your fingertip to flip the pom-pom into a basket.

POM-POM BASKETBALL PATTERN

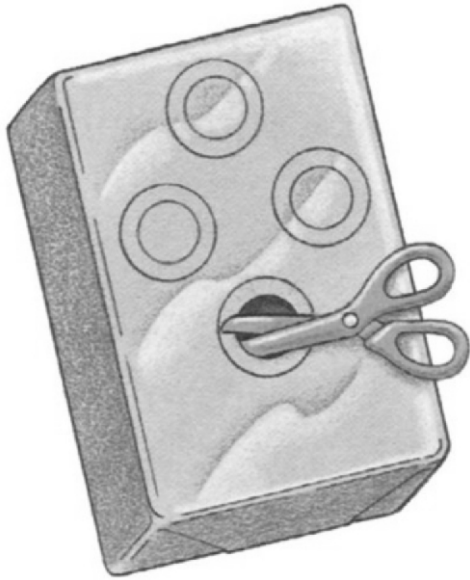

FIGURE 1

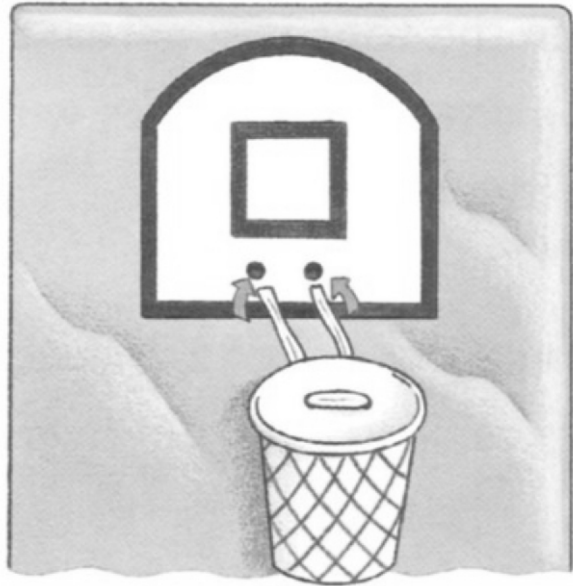
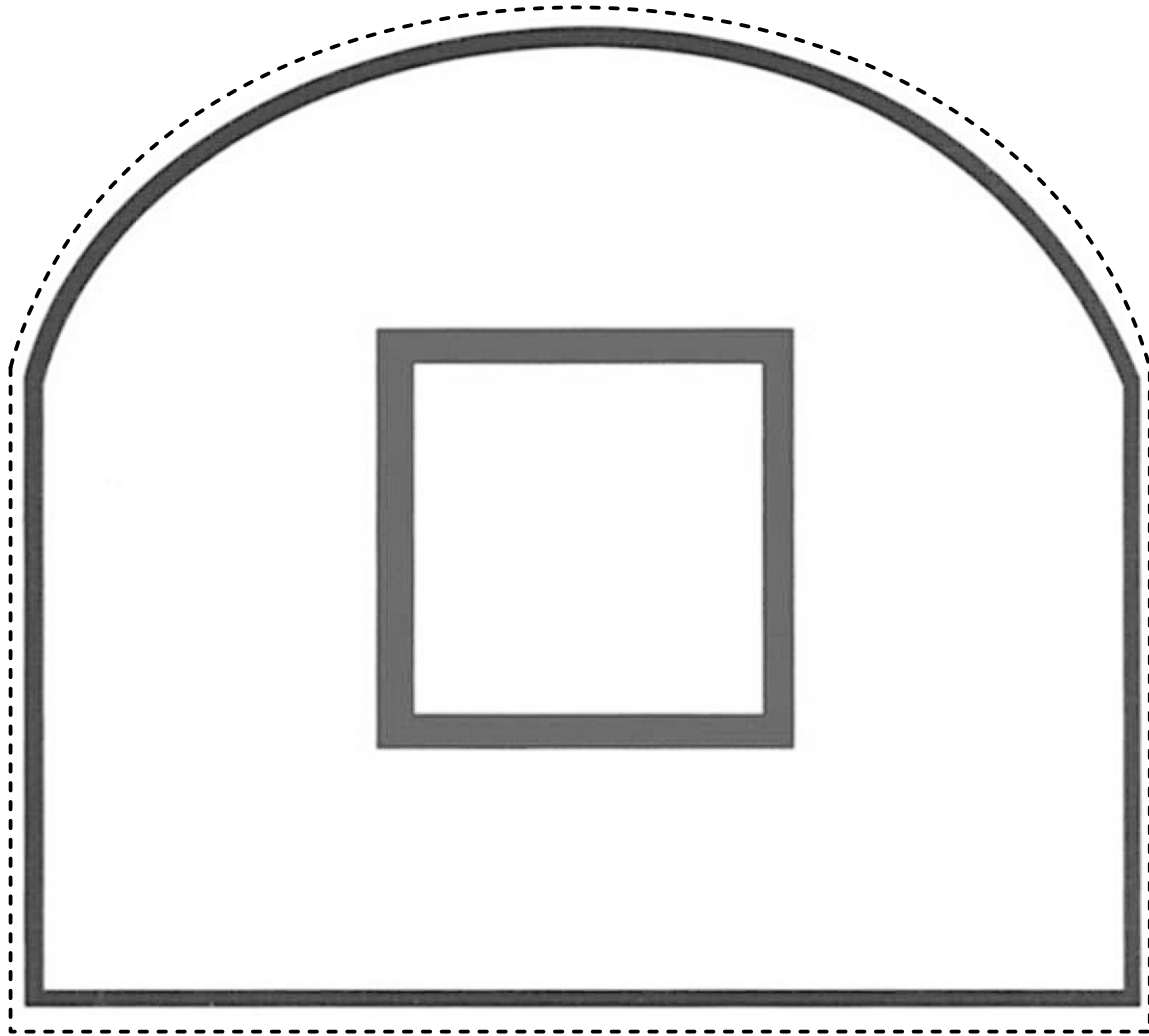

FIGURE 2



PUZZLES

MATERIALS

- puzzle pattern (p. 85)
- colors, crayons, markers
- glue
- scissors
- cardboard (folder, cereal box)

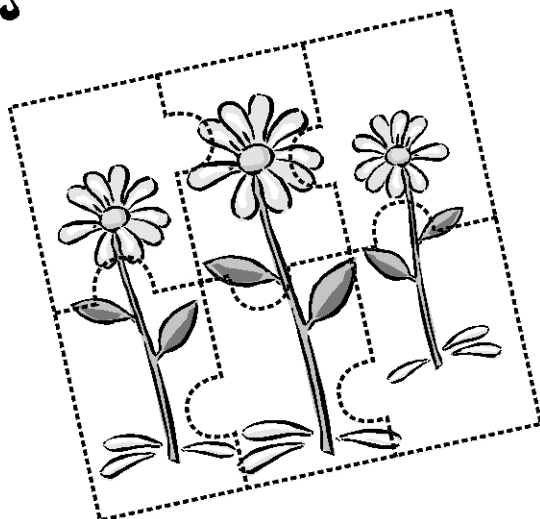

INSTRUCTIONS

1. Draw a picture onto the puzzle pattern and color.
 2. Glue the pattern onto the cardboard.
 3. Cut out the puzzle pieces and try to put it back together!
- * Let students try to draw their own puzzle shapes.

PUZZLE PATTERN

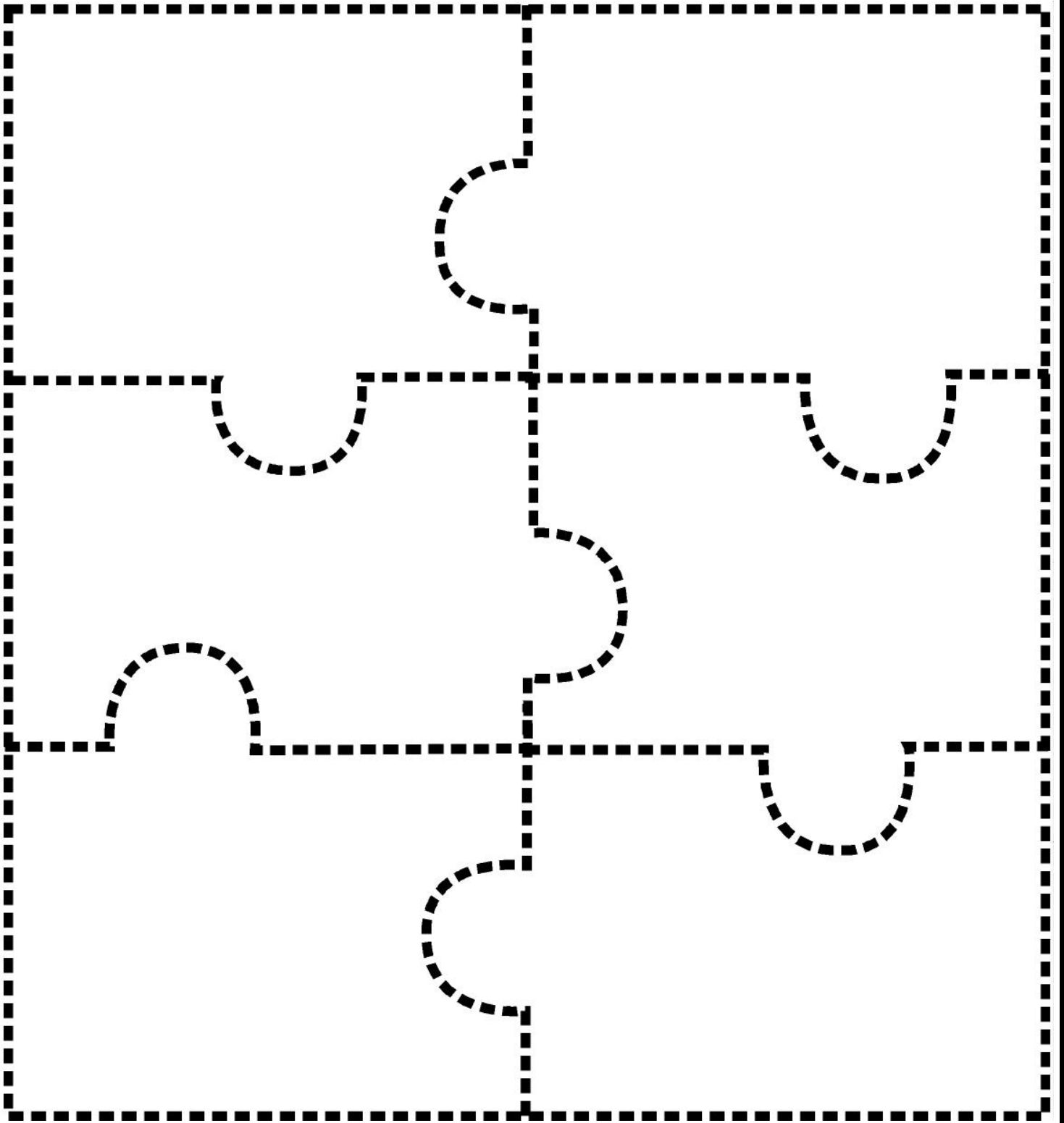

SNAILS

MATERIALS

- pattern (p. 87)
- thin cardboard (folder, cereal box)
- glue
- scissors
- coins, buttons (to use as game markers)
- a die

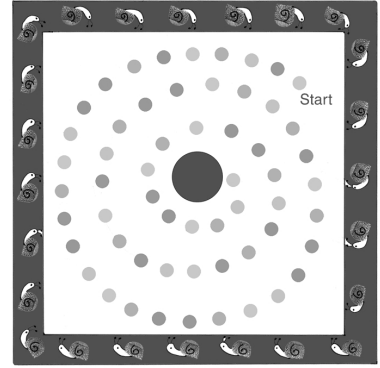

INSTRUCTIONS

1. Glue game pattern onto the thin cardboard and cut out.
2. Use a coin or button as game marker.
3. Begin at START. Roll the die to see who goes first. Highest roll begins. Roll the die and move the indicated number of spaces. When a player lands on a blue circle, he gets another turn. First player to get to the RED circle in the center wins.

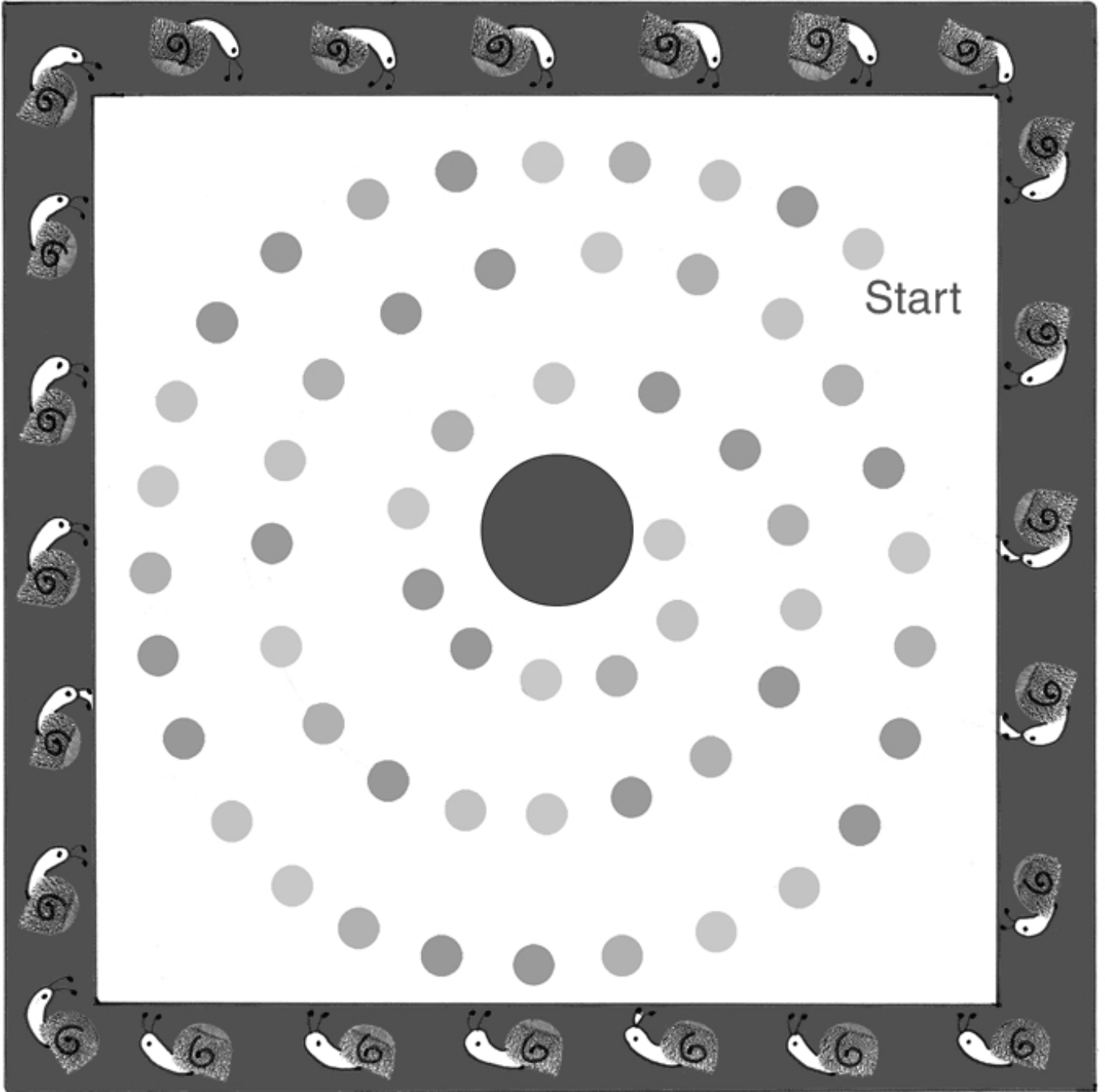

TIC TAC TOE

MATERIALS

- tic – tac – toe patterns (pp. 89, 90)
- colors, crayons, markers
- cardboard (folder, cereal box)
- glue
- scissors

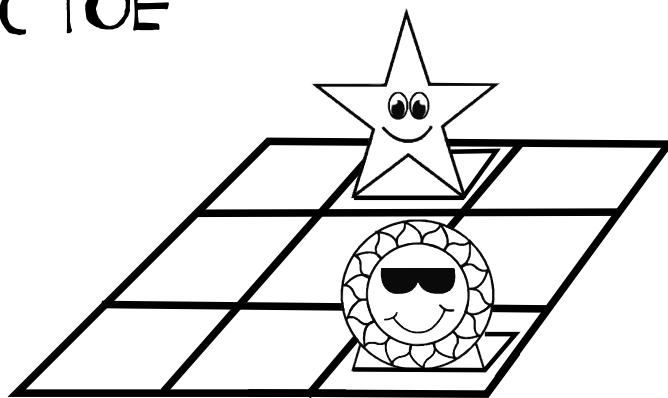

INSTRUCTIONS

1. Color and decorate the tic – tac – toe patterns.
2. Glue onto the cardboard and cut out the pieces and the board along the solid line.
3. Make a standing base for the figures by folding them at the dotted line.
4. Play on the board.

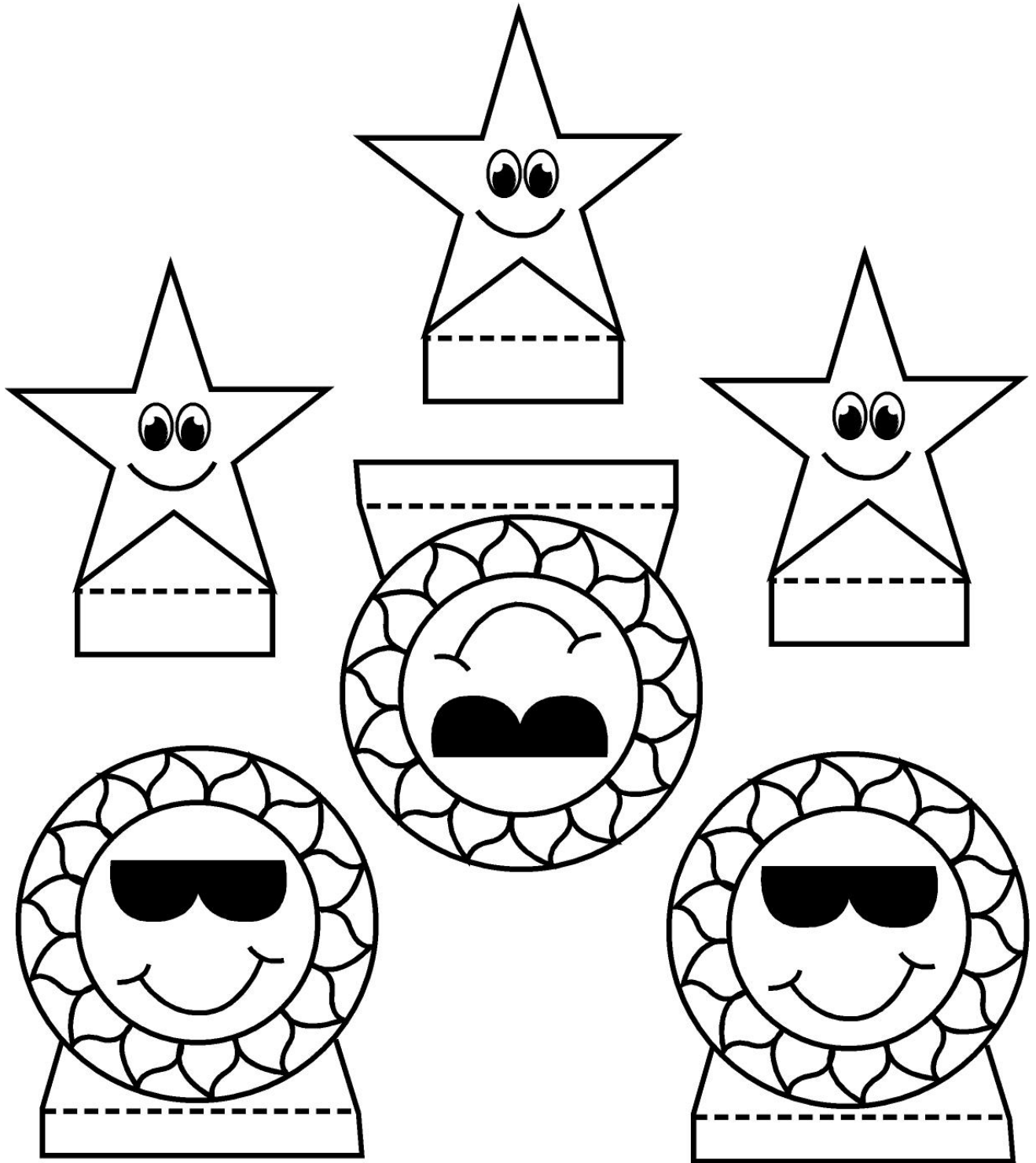





TIC TAC TOE BOARD

| | | |
|--|--|--|
| | | |
| | | |
| | | |

MASKS

INSTRUCTIONS

1. TRACE THE MASK PATTERN AND ALL ADDITIONAL PIECES ON FOAMY OR CARDBOARD, IN THE COLOR INDICATED BY THE NUMBER; SEE COLOR CODE.
2. CUT THE TRACED MASK AND ADDITIONAL PIECES ALONG THE CONTINUOUS LINE. 
3. GLUE ADDITIONAL PIECES INSIDE THE DOTTED AREA(S) ON THE MASK. 
4. CUT OUT ALL MARKED AREAS (NOSE, EYES) 
5. COLOR ALL SHADED AREAS IN THE COLOR INDICATED BY THE NUMBER; SEE COLOR CODE. 
6. PUNCH HOLES IN THE MARKED AREAS AND FASTEN ELASTIC OR YARN FROM ONE HOLE TO ANOTHER TO SECURE THE MASK ON THE STUDENT'S HEAD.
7. LET STUDENTS SHOW THEIR CREATIVITY BY DECORATING THE MASK.

COLOR CODE

- 1 BLACK
- 2 WHITE
- 3 RED
- 4 ORANGE
- 5 YELLOW
- 6 GREEN
- 7 LIGHT GREEN
- 8 BLUE
- 9 LIGHT BLUE
- 10 PURPLE
- 11 VIOLET
- 12 PINK
- 13 LIGHT PINK
- 14 BROWN
- 15 LIGHT BROWN
- 16 BEIGE
- 17 GRAY
- 18 LIGHT GRAY

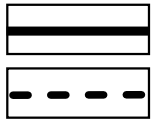

CUT ALONG
THE LINE

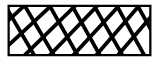

CUT

GLUE

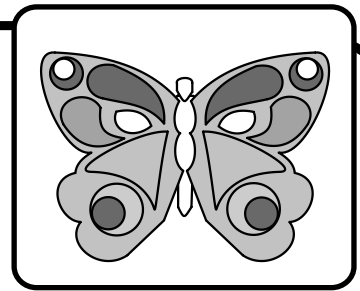

BUTTERFLY

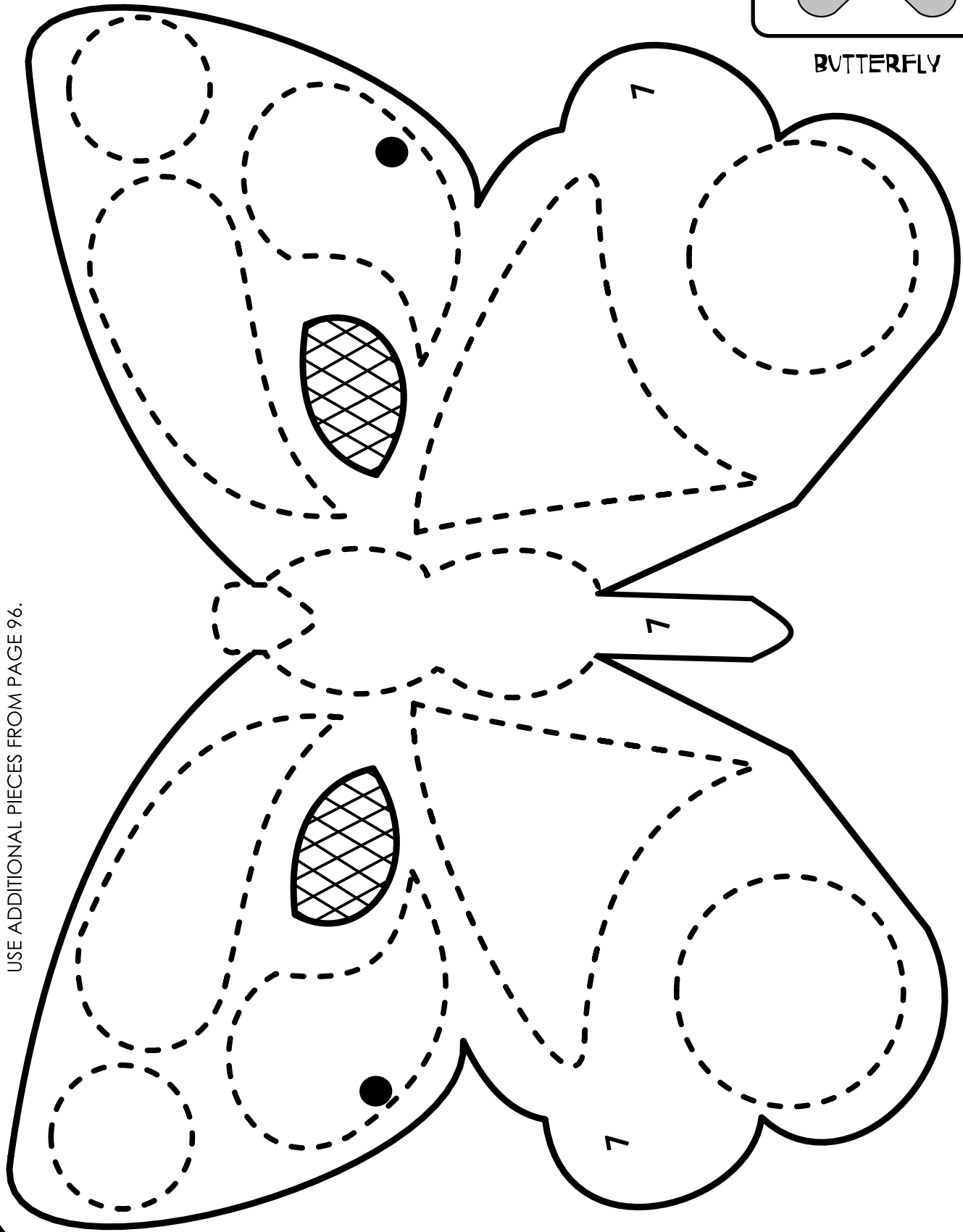

USE ADDITIONAL PIECES FROM PAGE 96.

BUTTERFLY PATTERNS

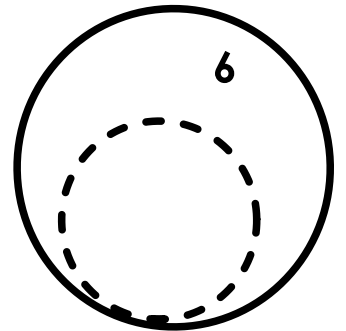
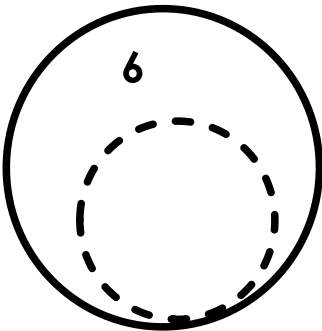
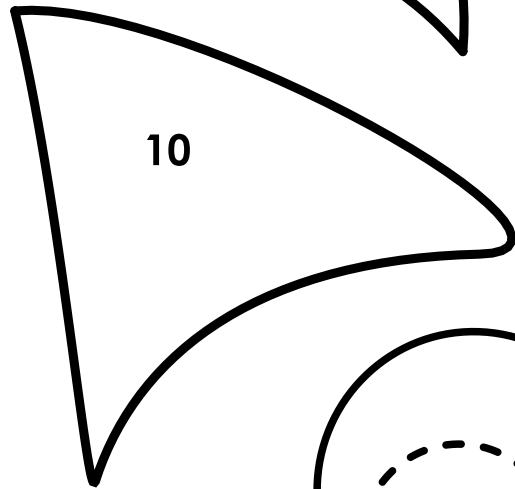
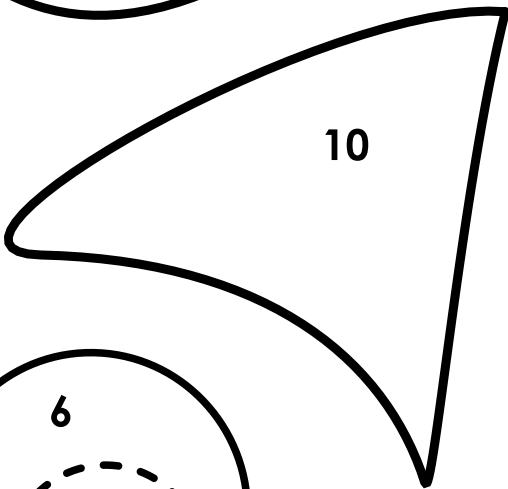
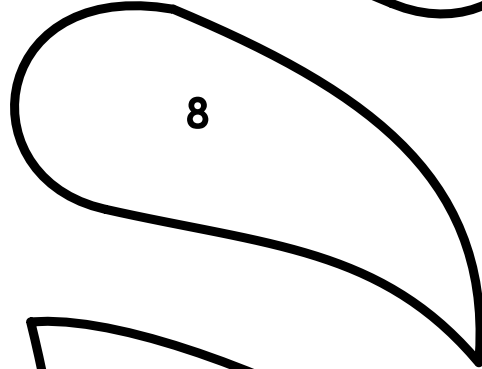
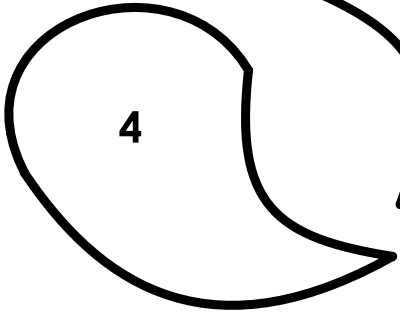
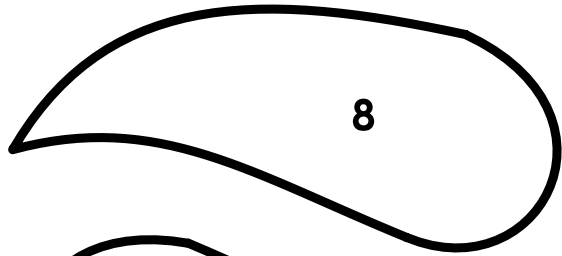
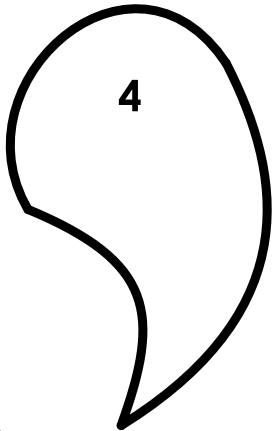
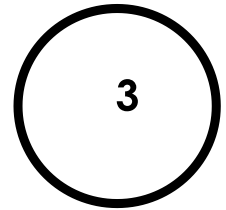
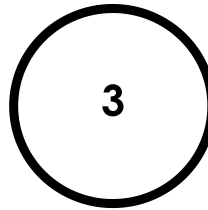
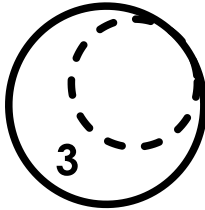
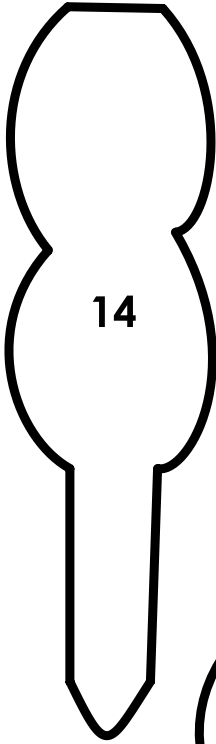

USE WITH MASK PATTERN ON PAGE 95.

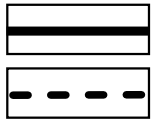

CUT ALONG THE LINE

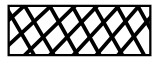

CUT

GLUE

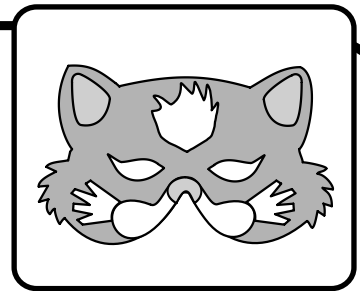

CAT 1

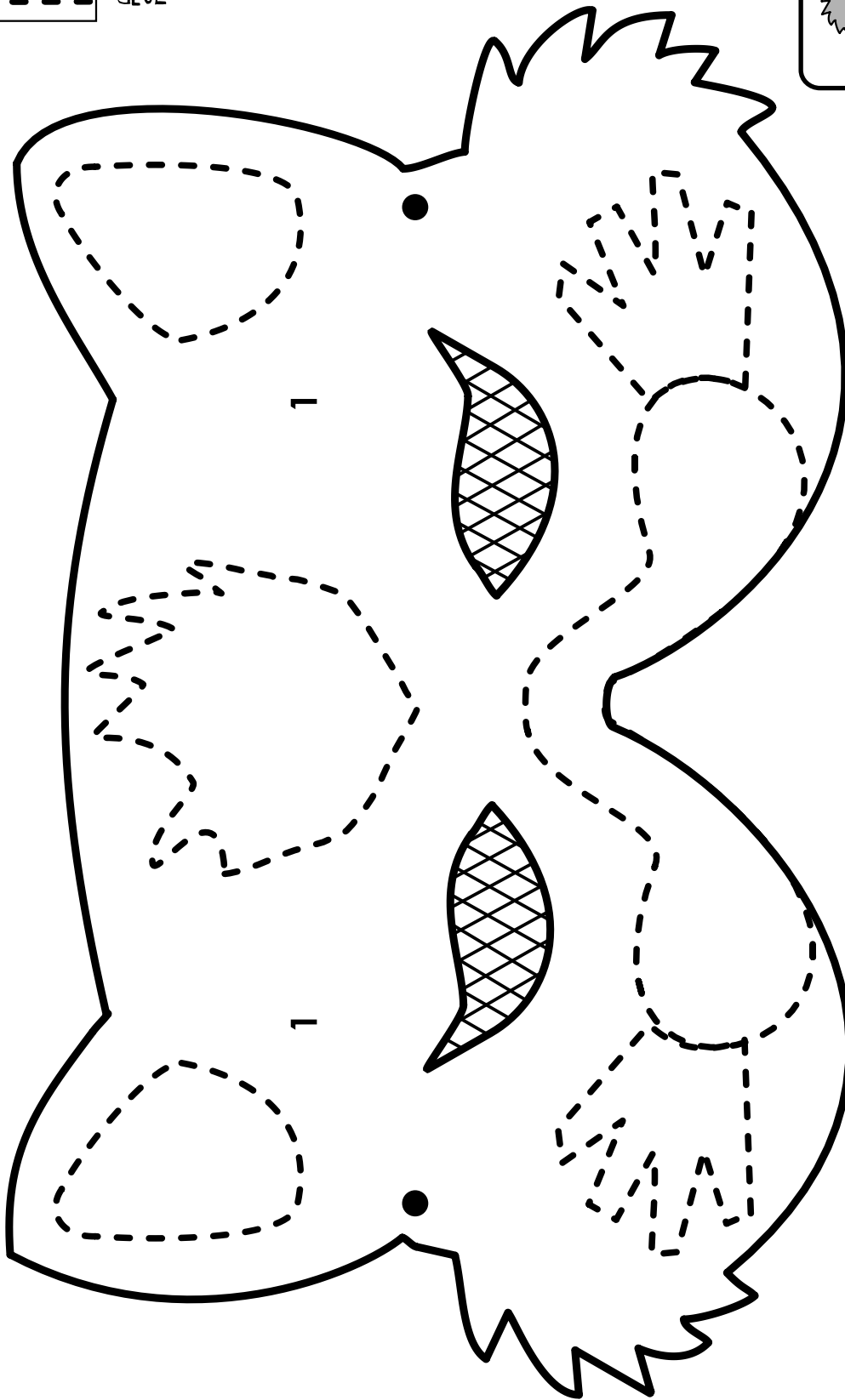

USE ADDITIONAL PIECES FROM PAGE 98.

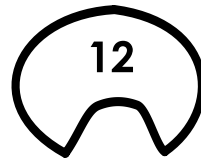
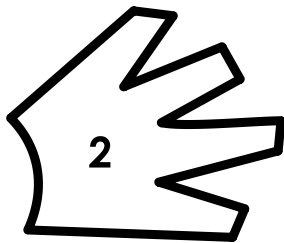
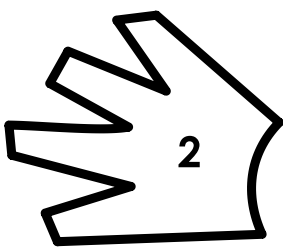
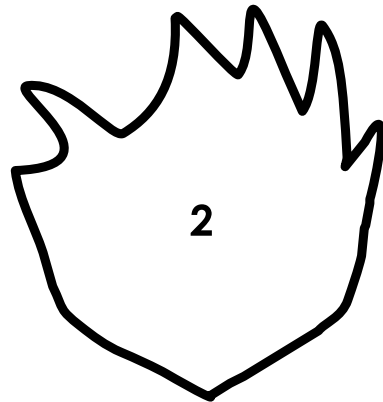
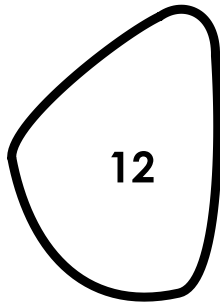
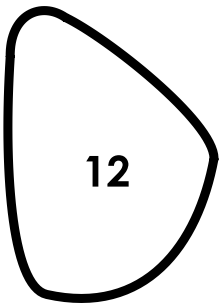
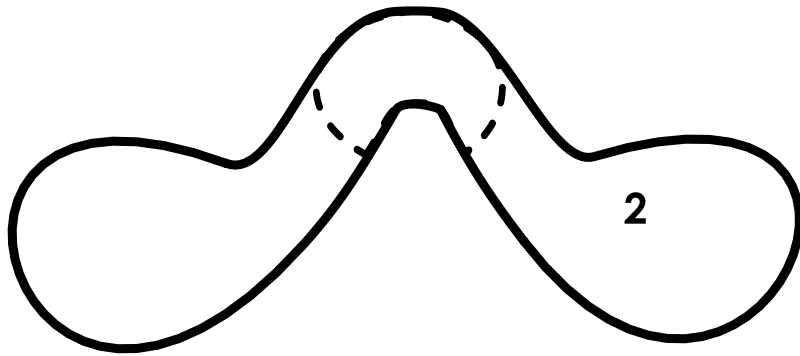

USE WITH MASK PATTERN ON PAGE 97.

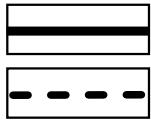

CUT ALONG THE LINE



CUT

GLUE

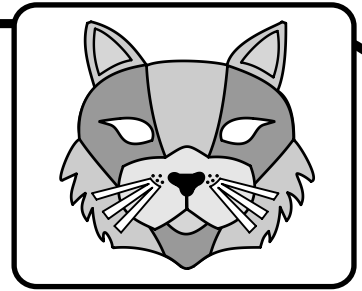

CAT 2

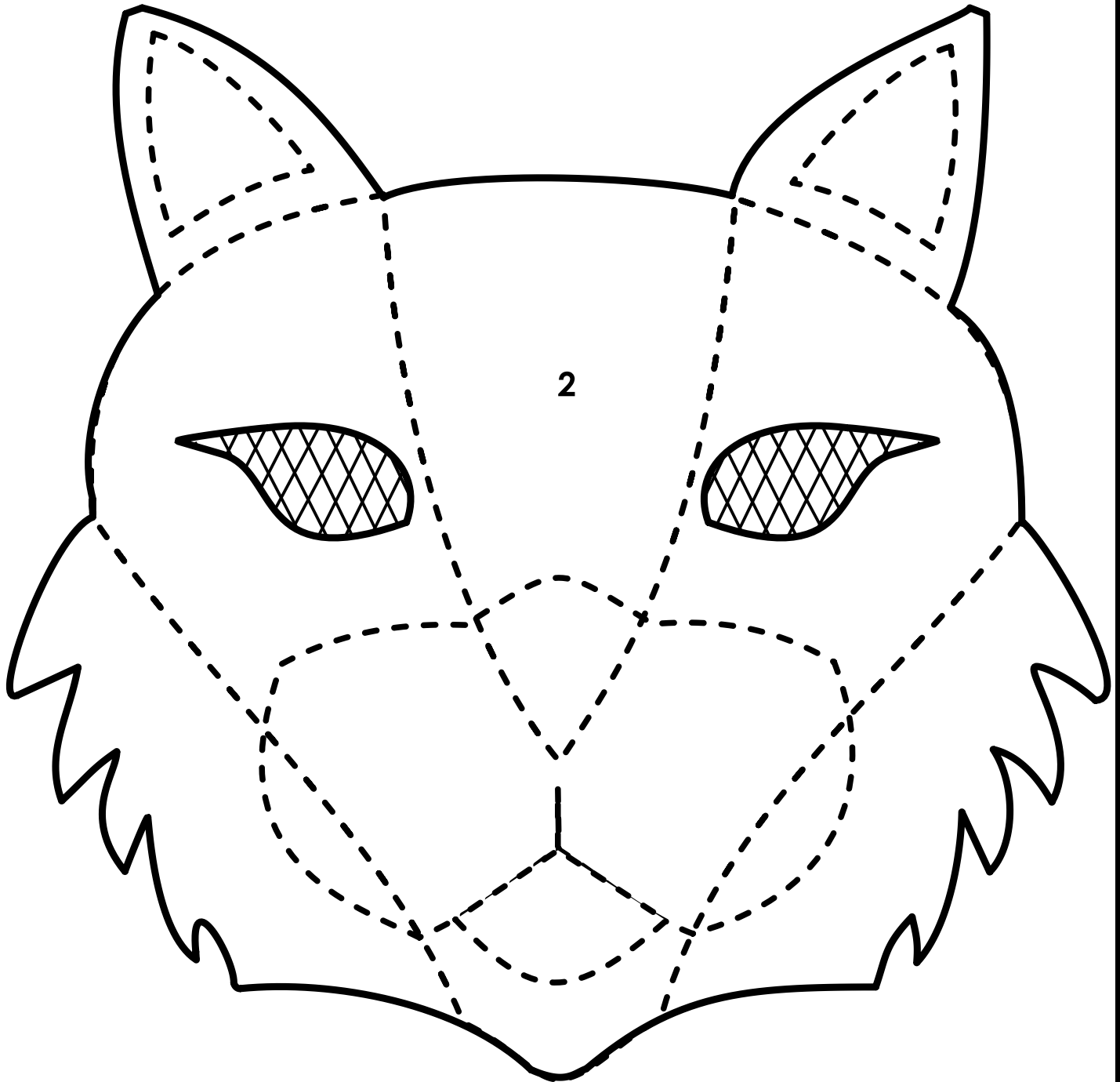

2

USE ADDITIONAL PIECES FROM PAGE 100.

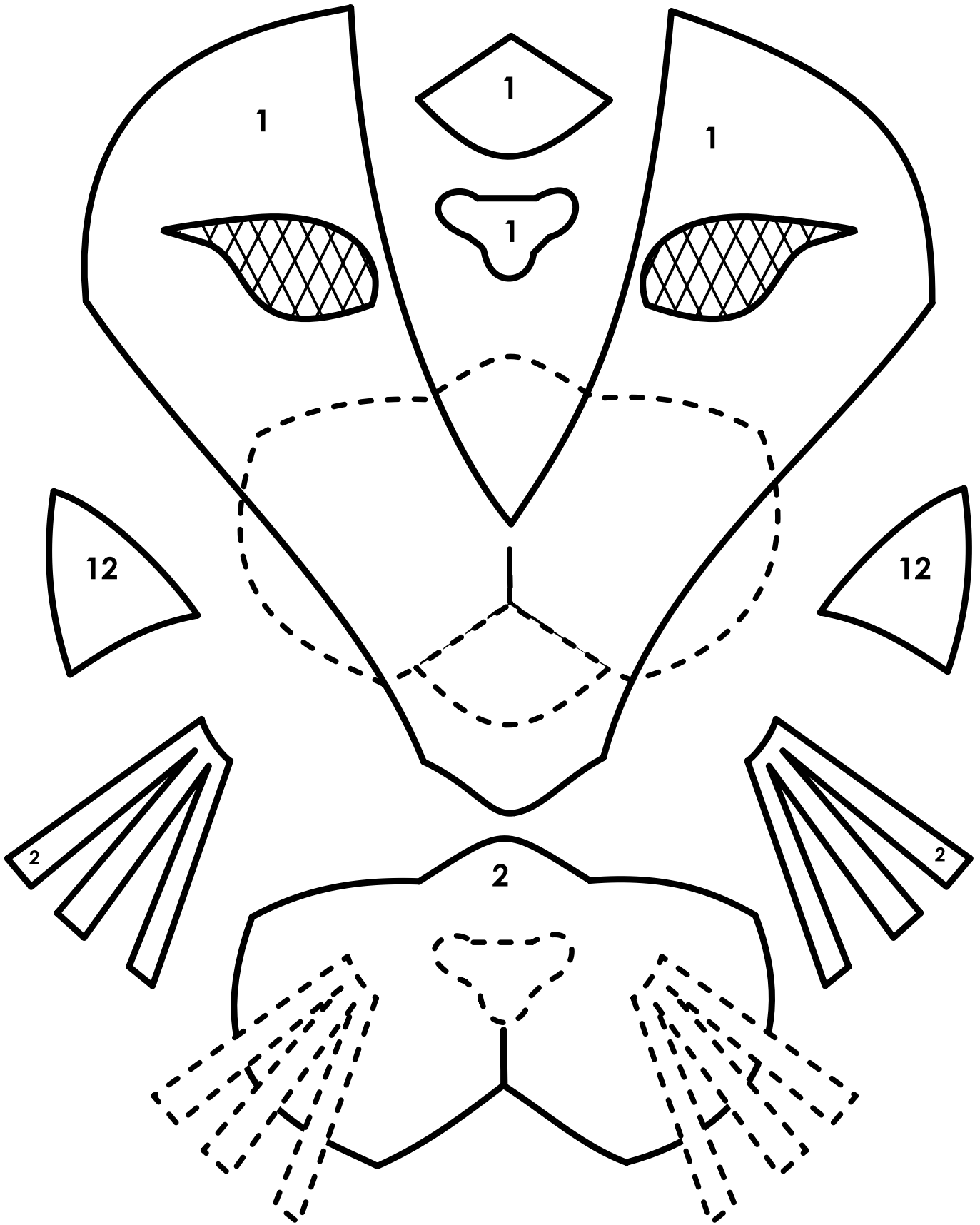

USE WITH MASK PATTERN ON PAGE 99.

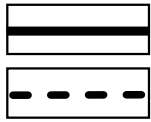

CUT ALONG THE LINE



CUT

GLUE

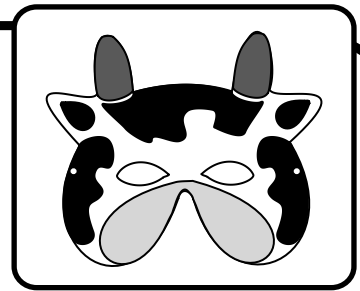

COW

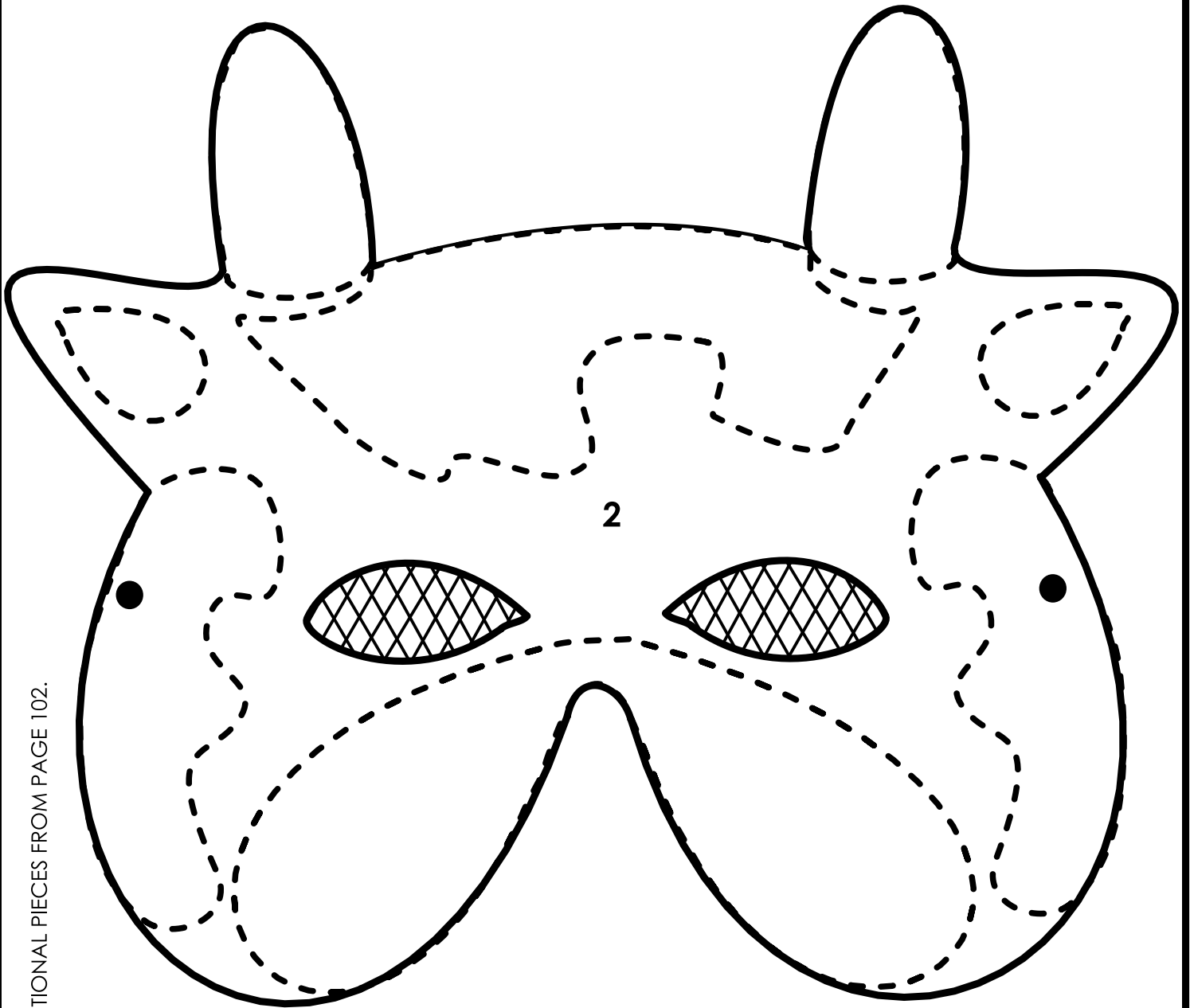

USE ADDITIONAL PIECES FROM PAGE 102.

COW PATTERNS

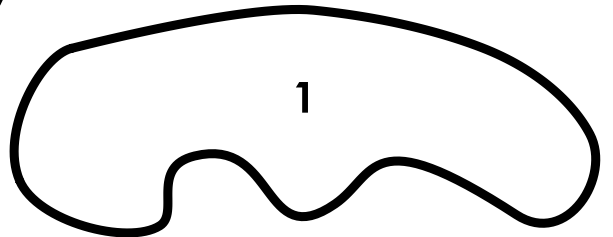
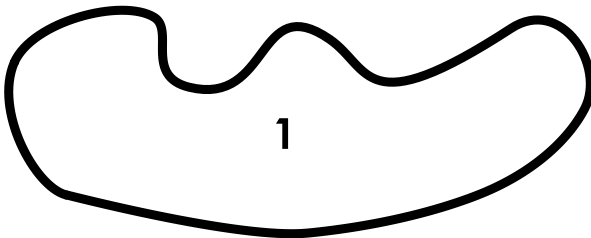
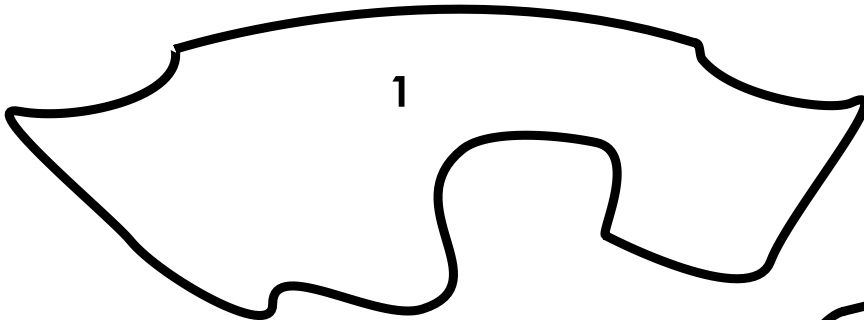
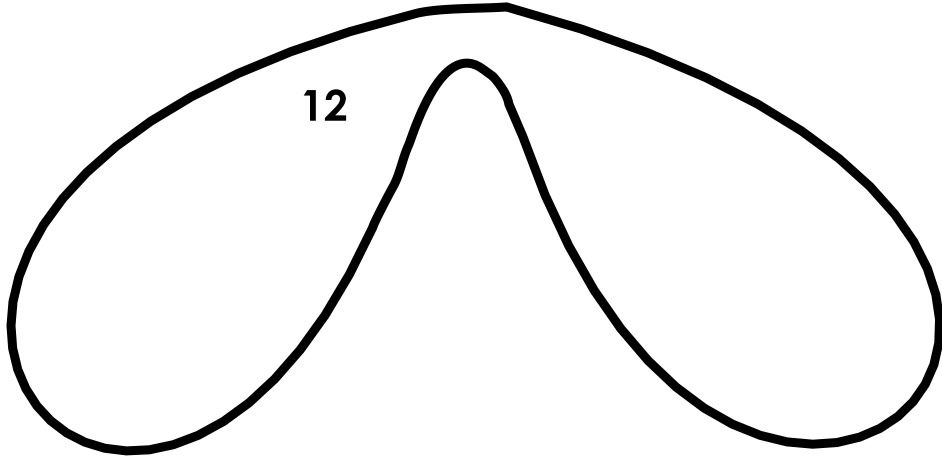
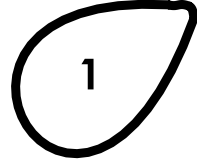
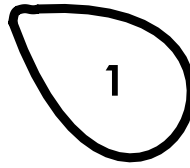
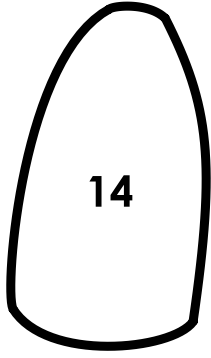
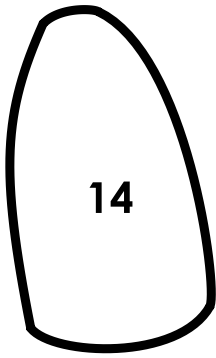

USE WITH MASK PATTERN ON PAGE 101.

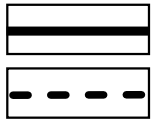

CUT ALONG THE LINE

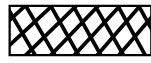

CUT

GLUE

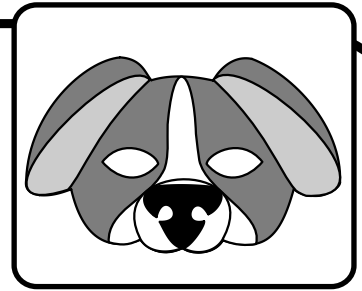

DOG

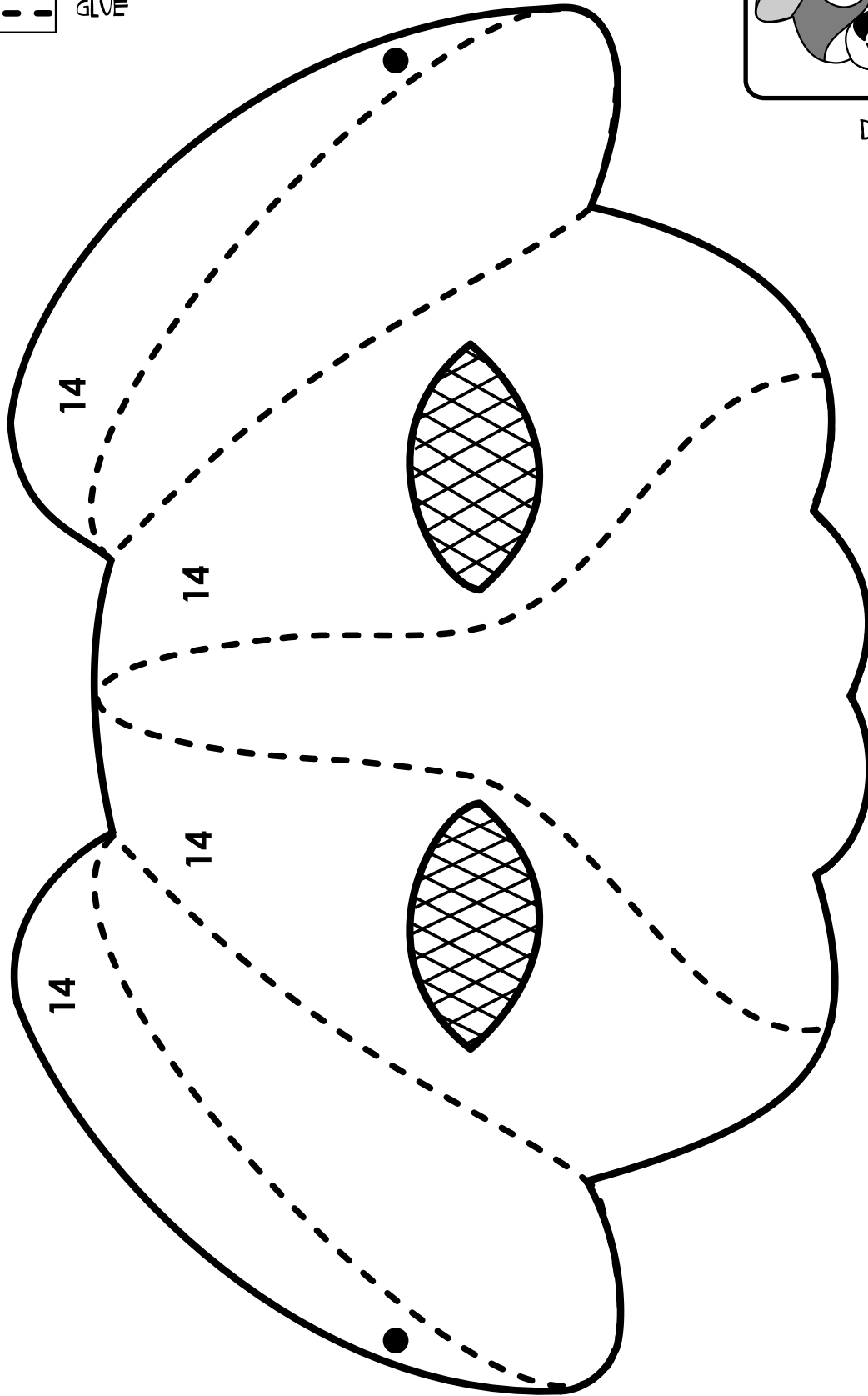

USE ADDITIONAL PIECES FROM PAGE 104.

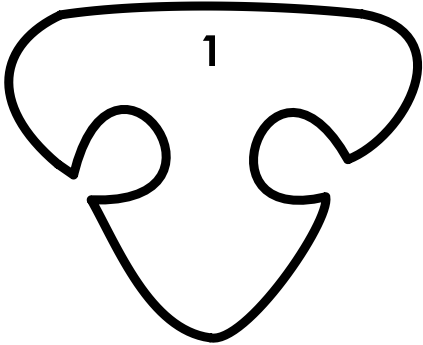
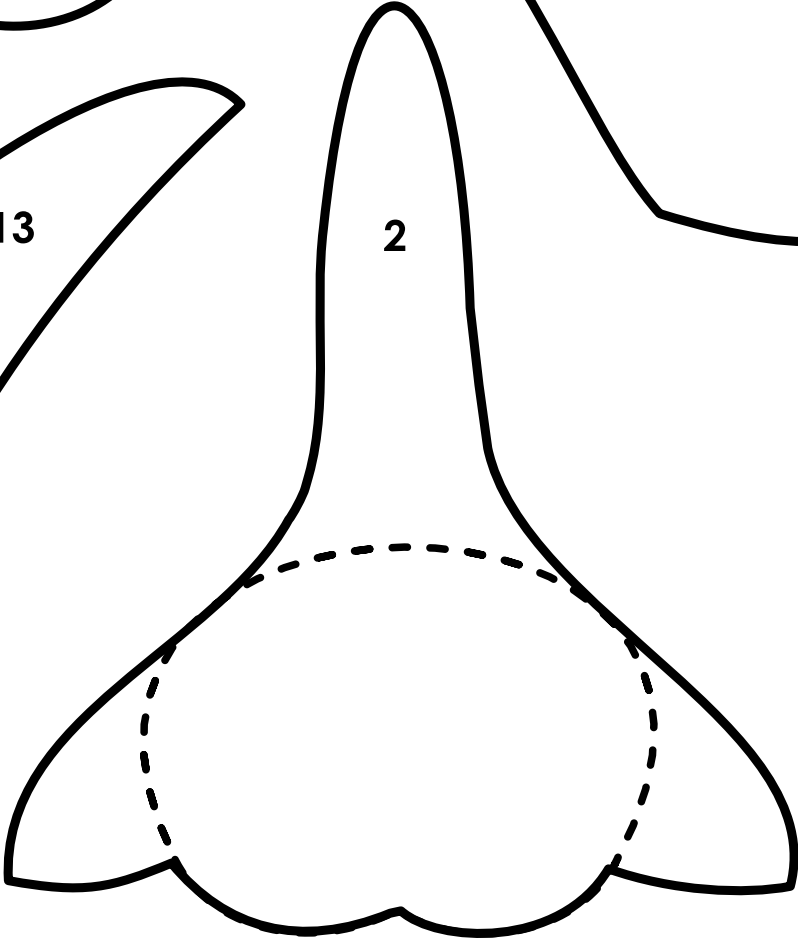
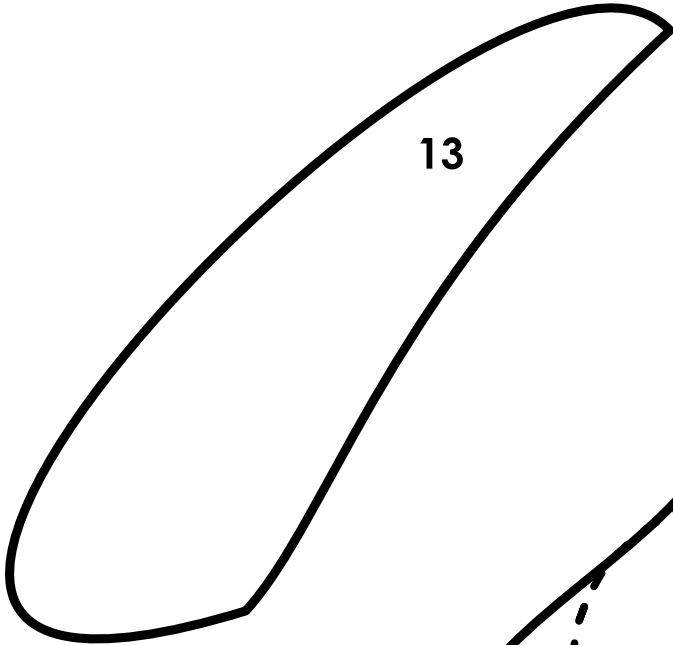
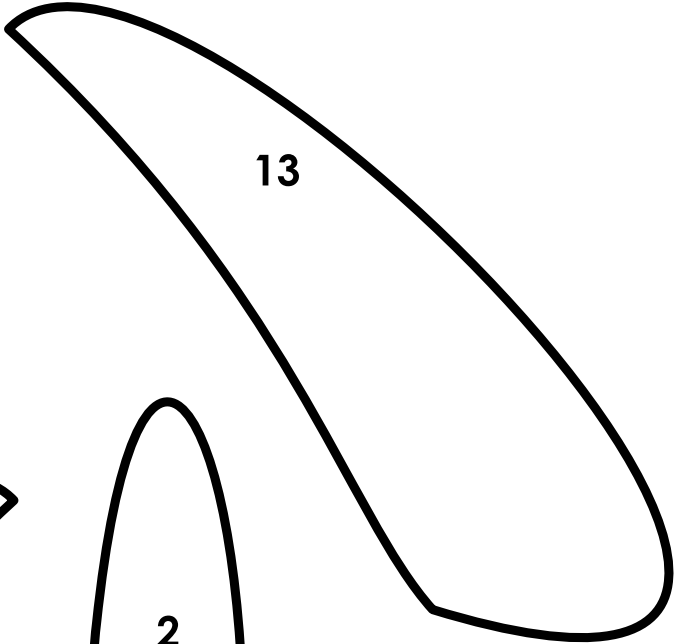
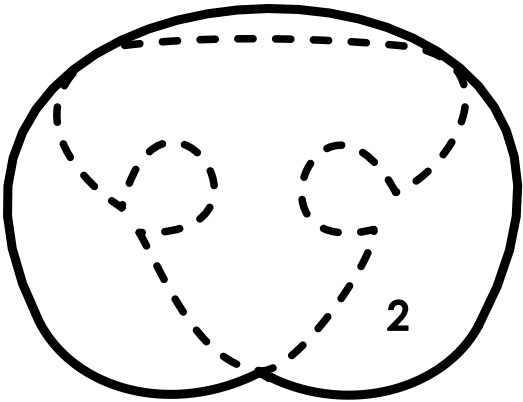

USE WITH MASK PATTERN ON PAGE 103.

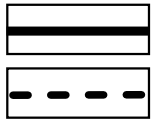

CUT ALONG THE LINE

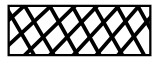

CUT

GLUE

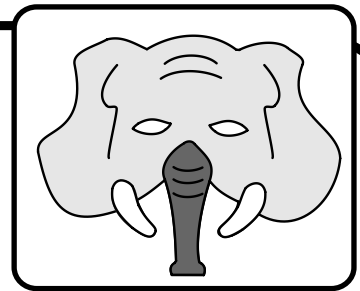

ELEPHANT

18

18

USE ADDITIONAL PIECES FROM PAGE 106.

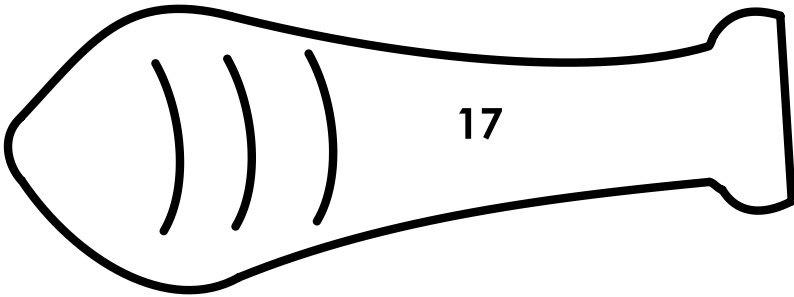
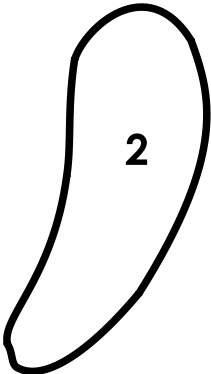
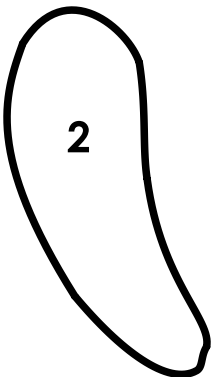

USE WITH MASK PATTERN ON PAGE 105.

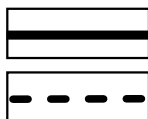

CUT ALONG THE LINE



CUT

GLUE



COLOR

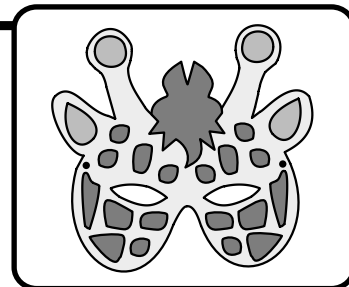

GIRAFFE

USE ADDITIONAL PIECES FROM PAGE 108. COLOR ALL SHADED AREAS. USE COLOR CODE 14.

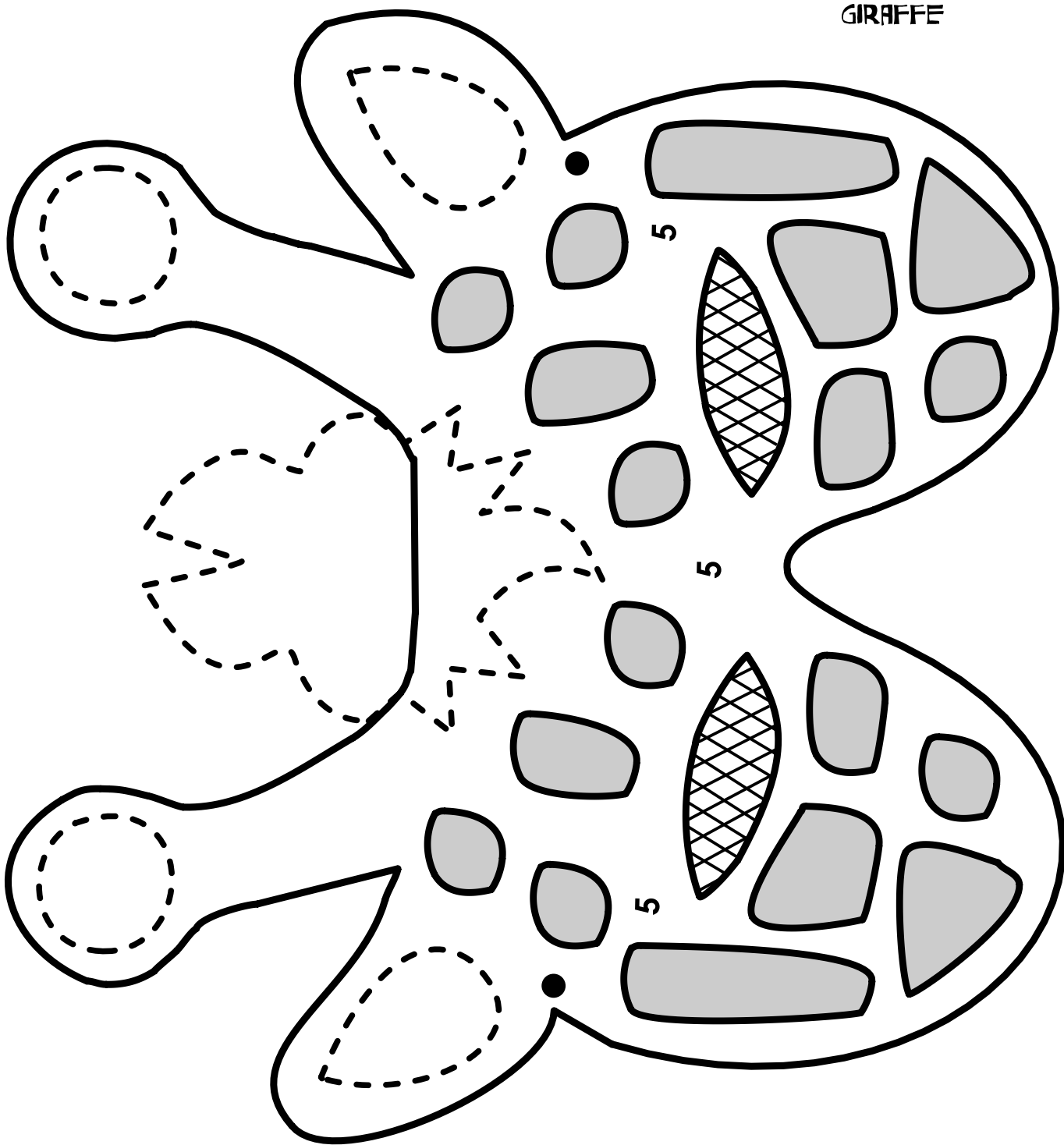

GIRAFFE PATTERNS

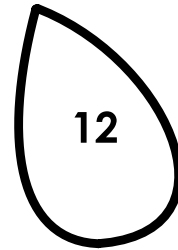
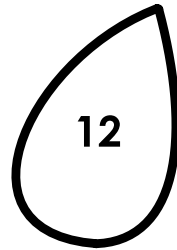
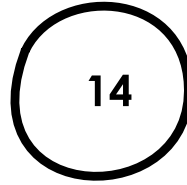
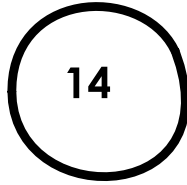
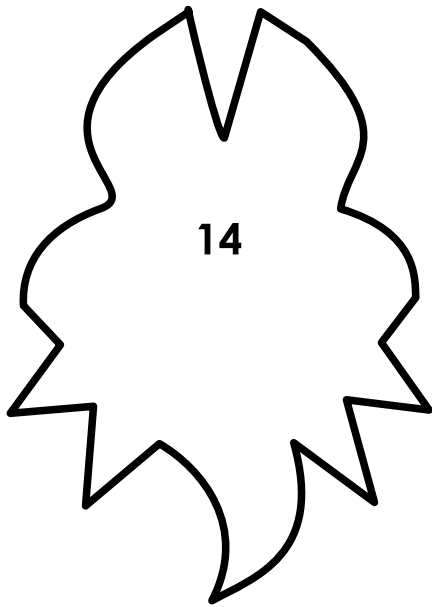

USE WITH MASK PATTERN ON PAGE 107.

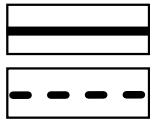

CUT ALONG THE LINE

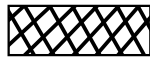

CUT

GLUE



LION

14

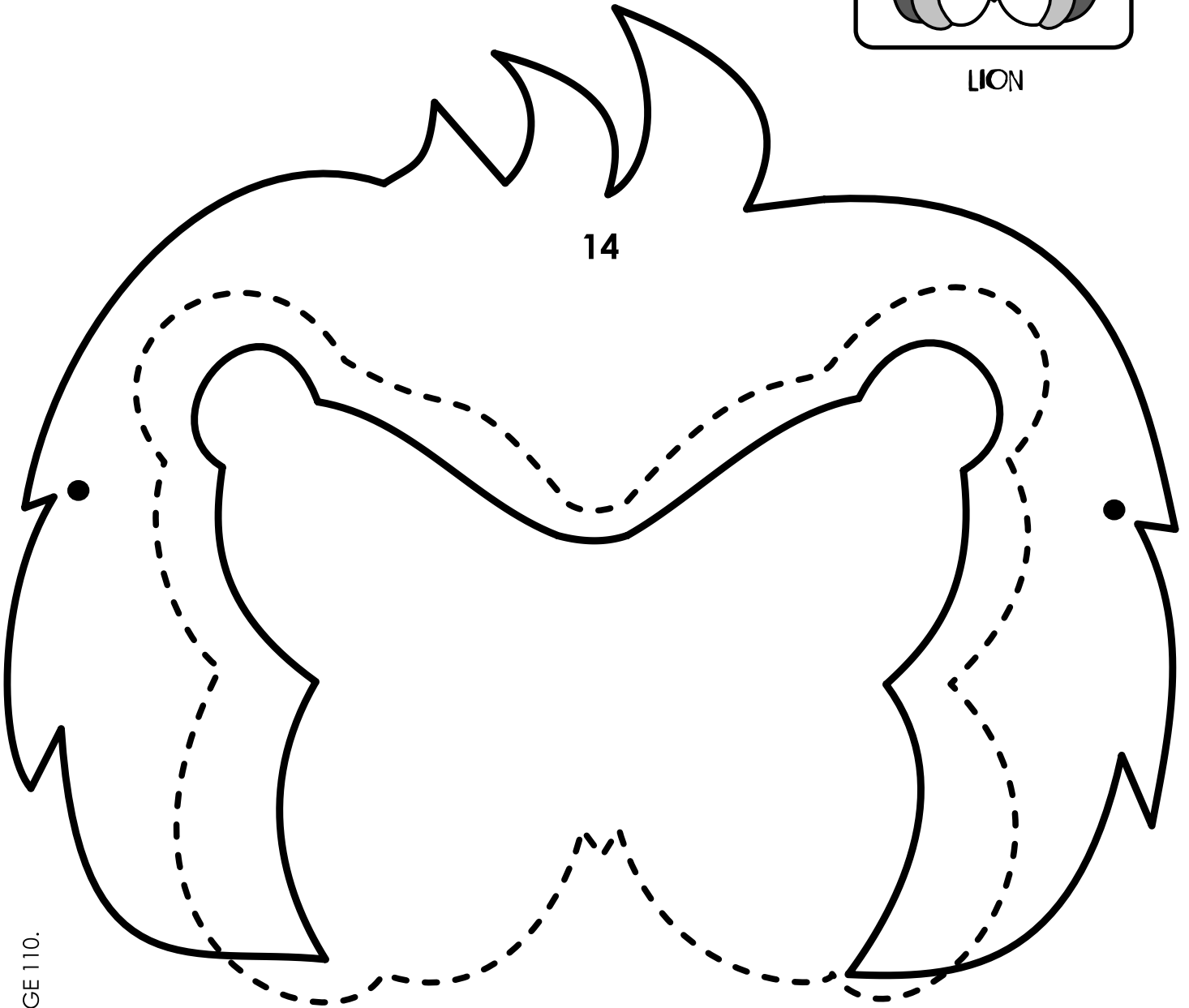

USE ADDITIONAL PIECES FROM PAGE 110.

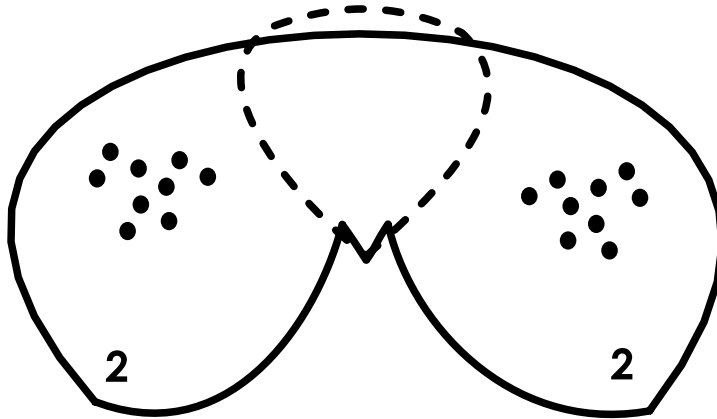
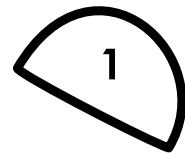
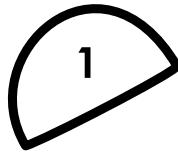
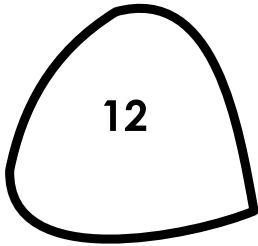
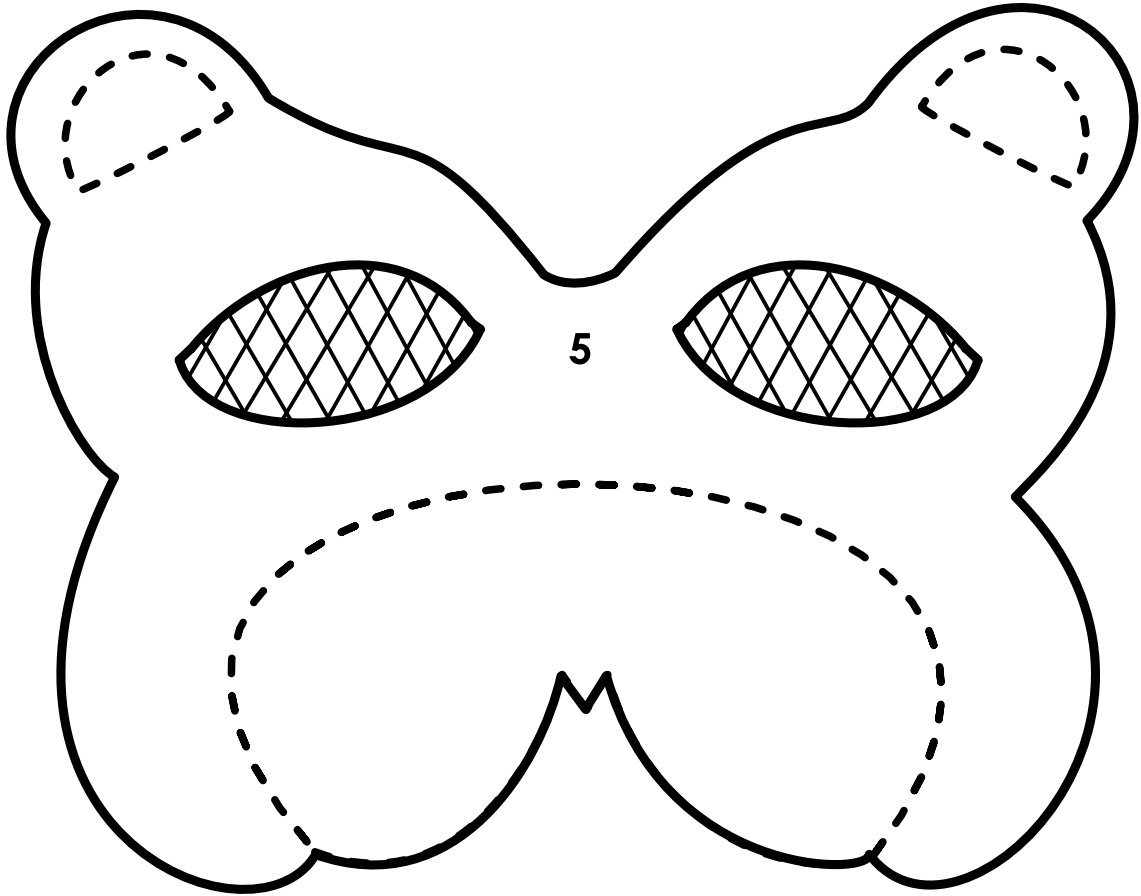

USE WITH MASK PATTERN ON PAGE 109.

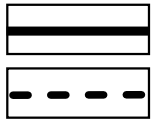

CUT ALONG THE LINE

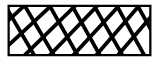

CUT

GLUE



COLOR

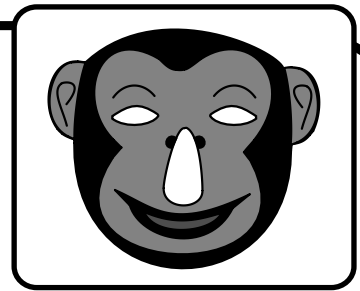

MONKEY

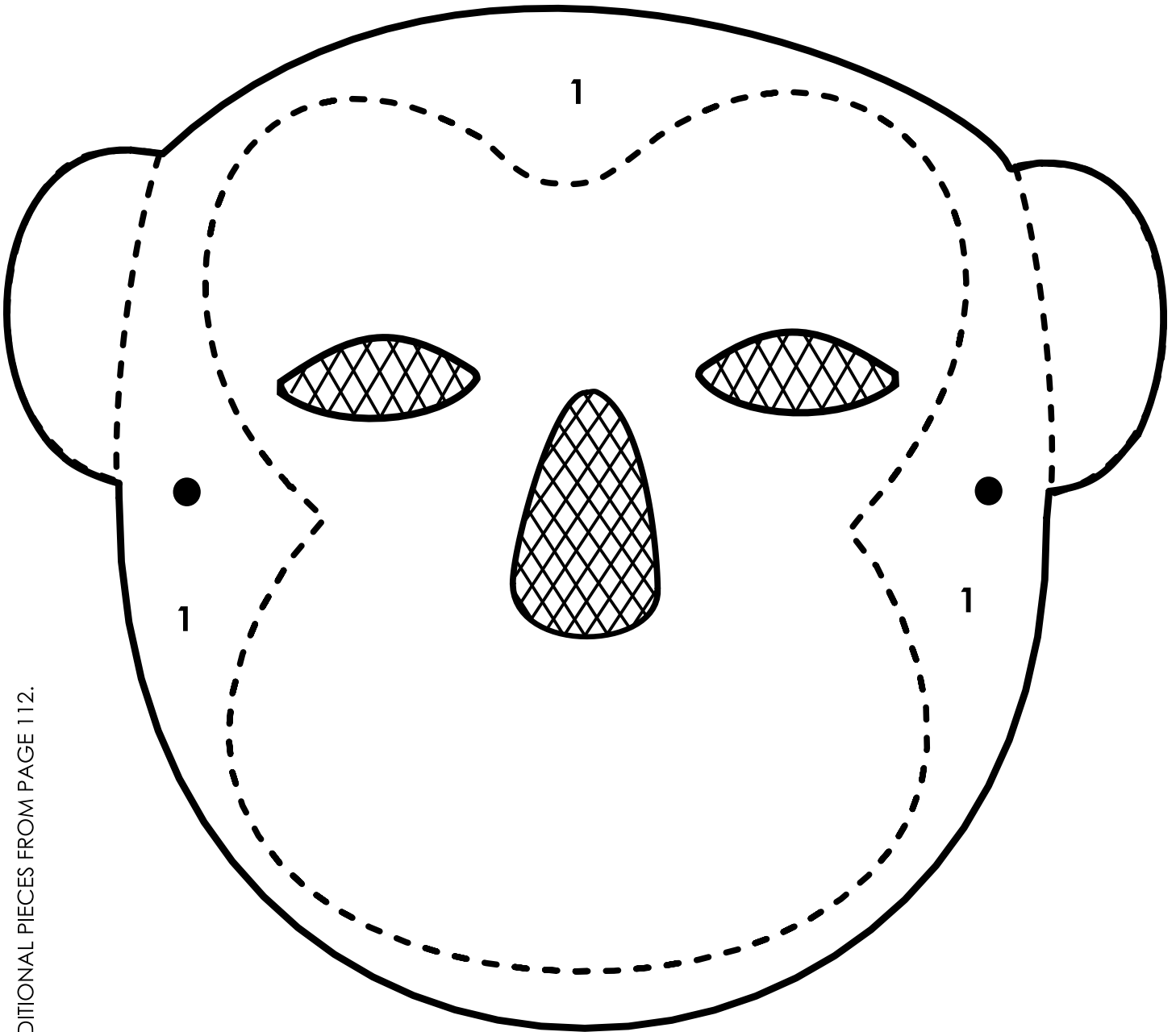

USE ADDITIONAL PIECES FROM PAGE 112.



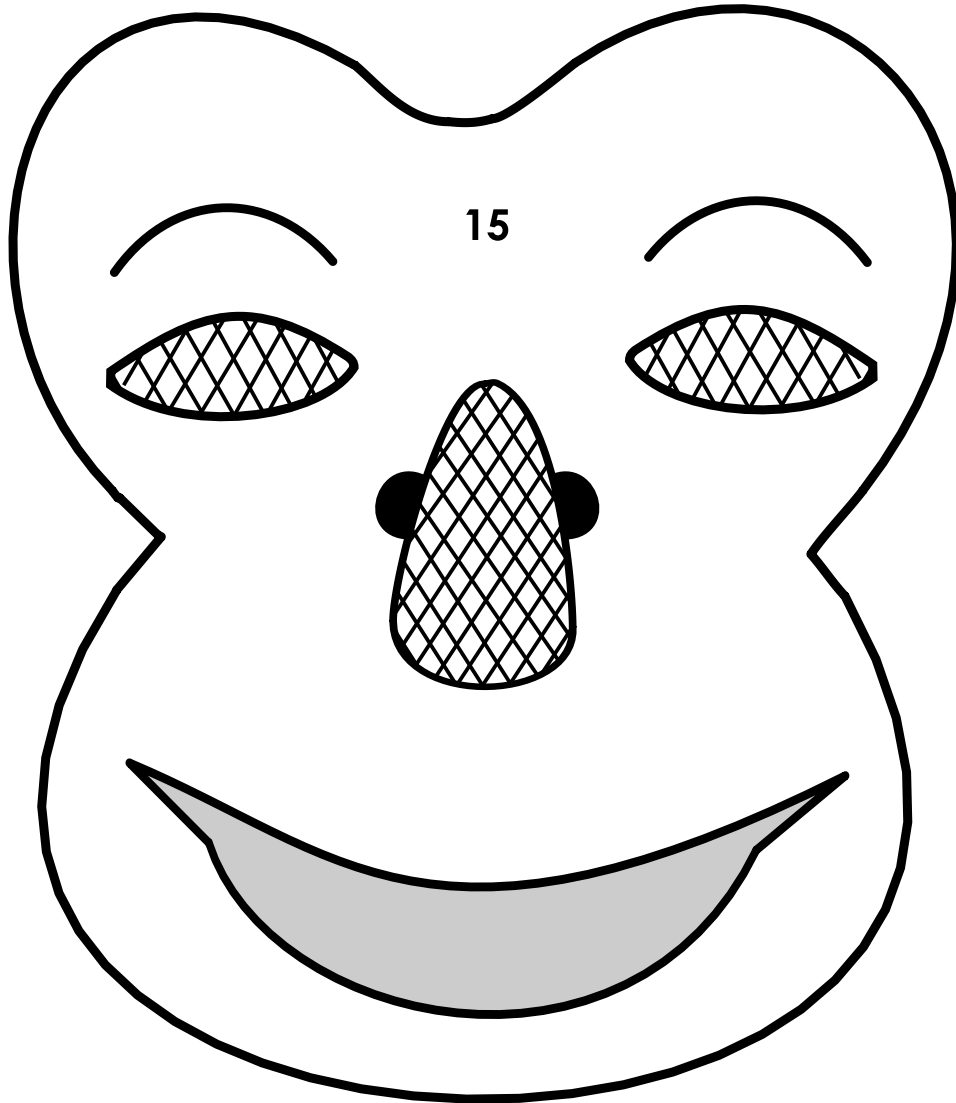

15

USE WITH MASK PATTERN ON PAGE 111. COLOR ALL SHADED AREAS. USE COLOR CODE 1.

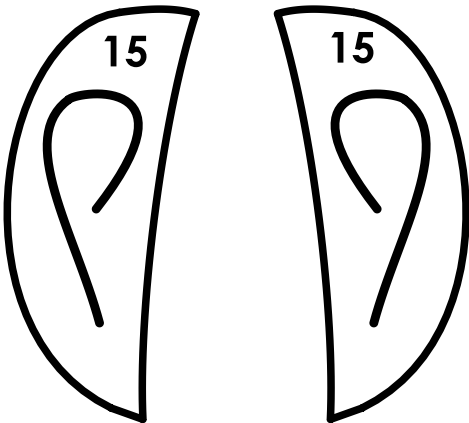

15

15

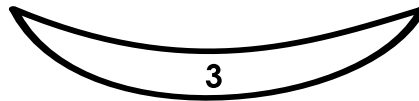

3

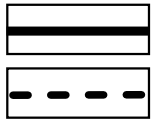

CUT ALONG THE LINE

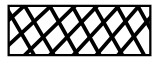

CUT

GLUE



COLOR

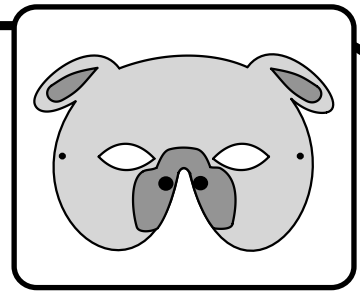

PIG

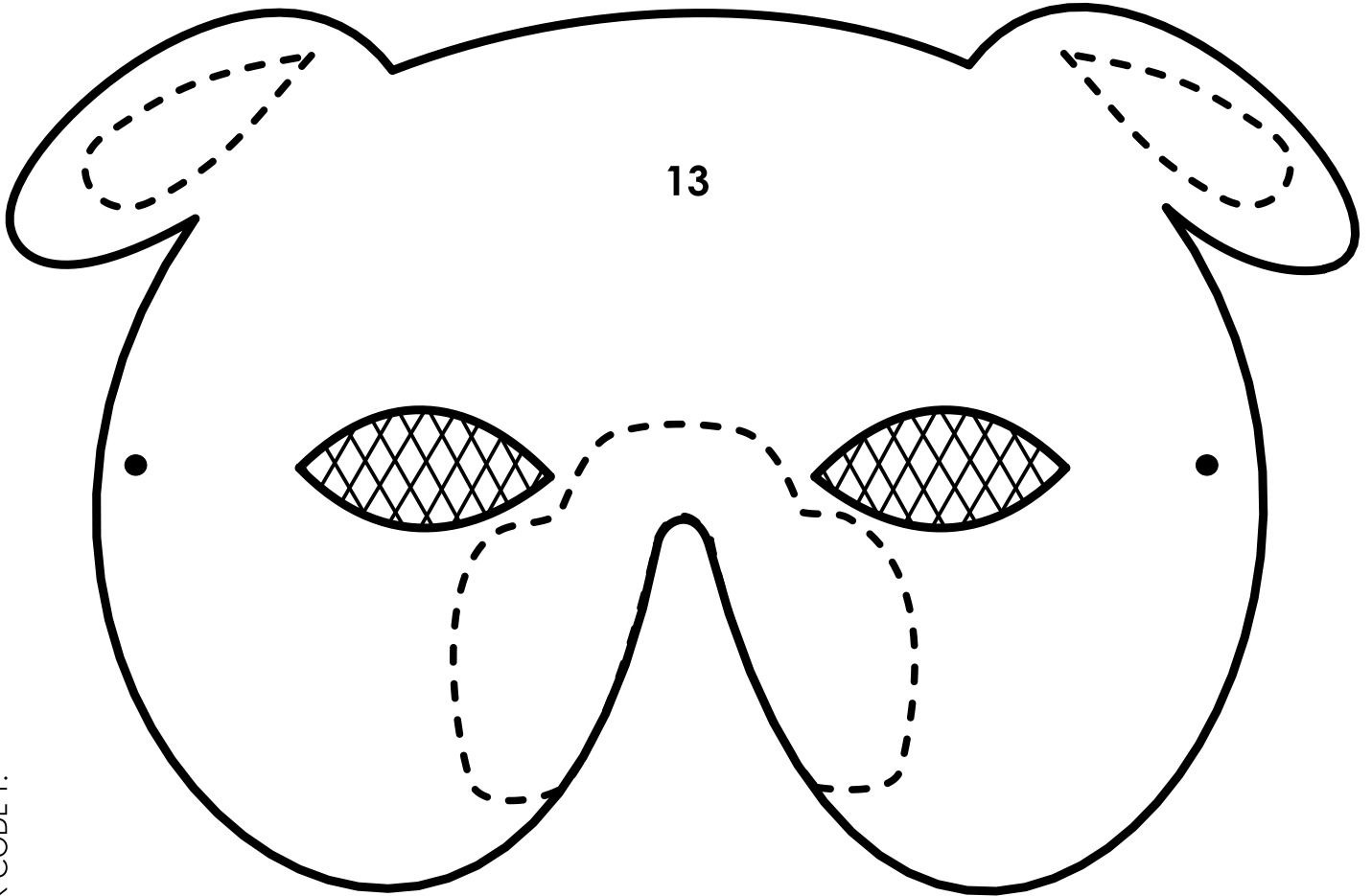

13

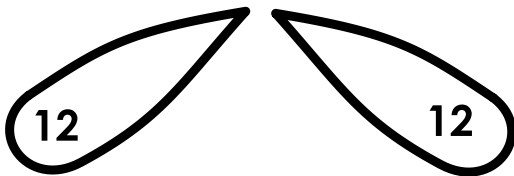

12

12

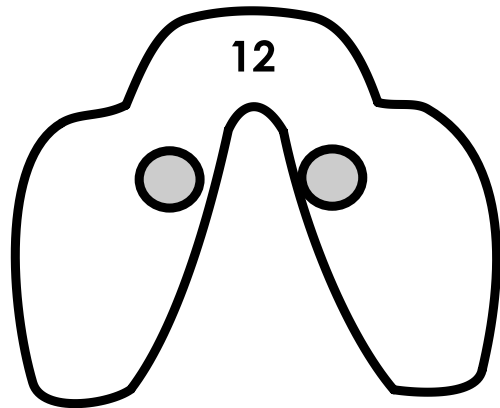

12

COLOR ALL SHADED AREAS. USE COLOR CODE 1.

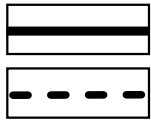

CUT ALONG THE LINE

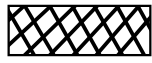

CUT

GLUE

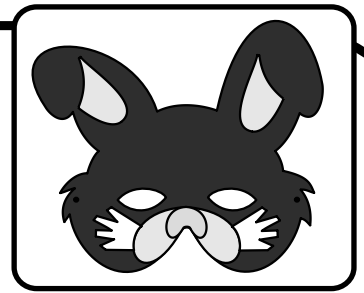

RABBIT

USE ADDITIONAL PIECES FROM PAGE 115.

14

RABBIT PATTERNS

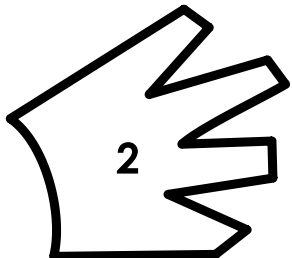
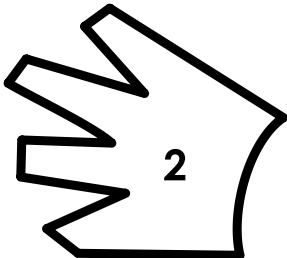
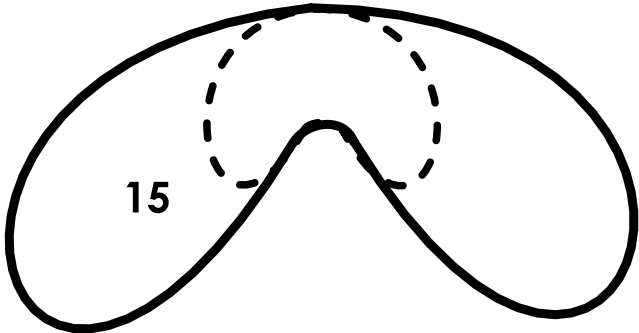
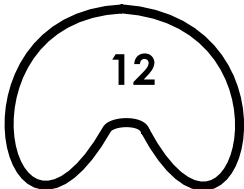
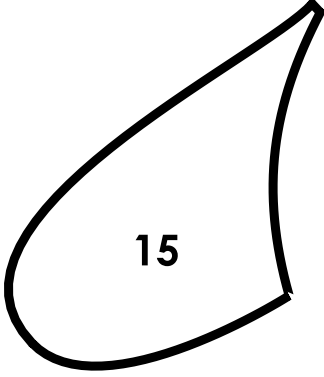
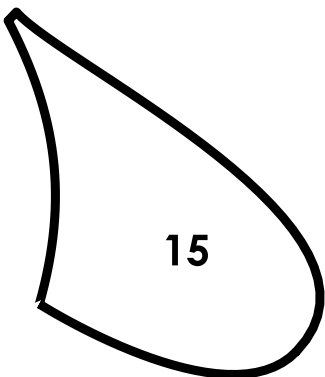

USE WITH MASK PATTERN ON PAGE 114.

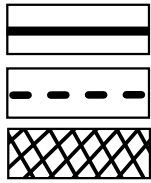

CUT ALONG
THE LINE

GLUE

CUT

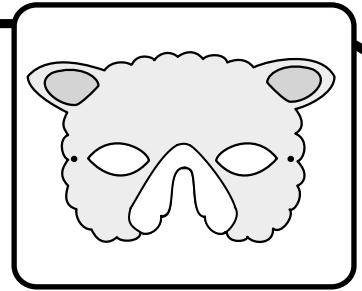

SHEEP

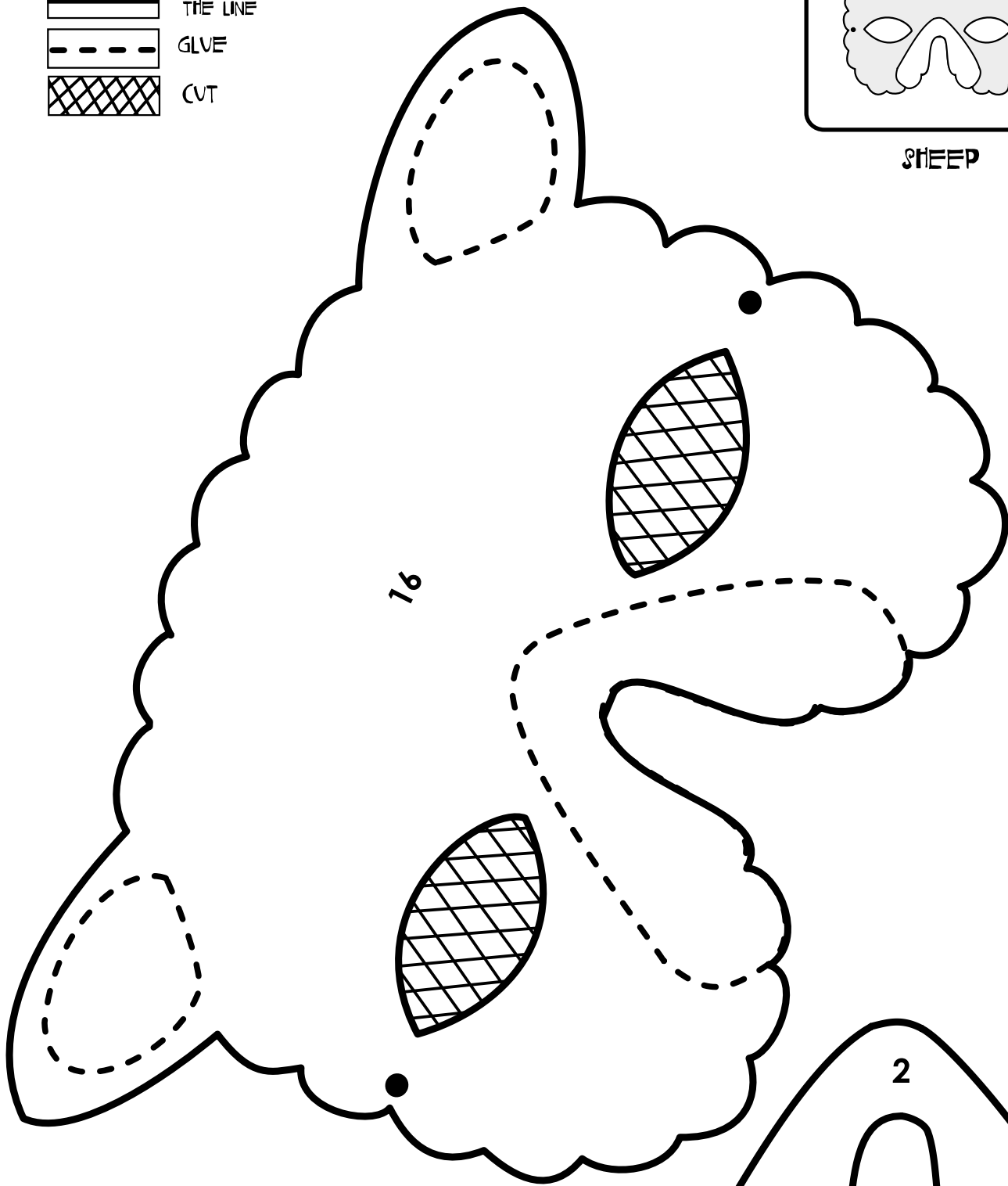

16

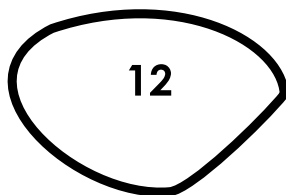

12

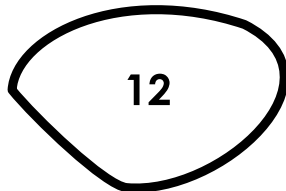

12

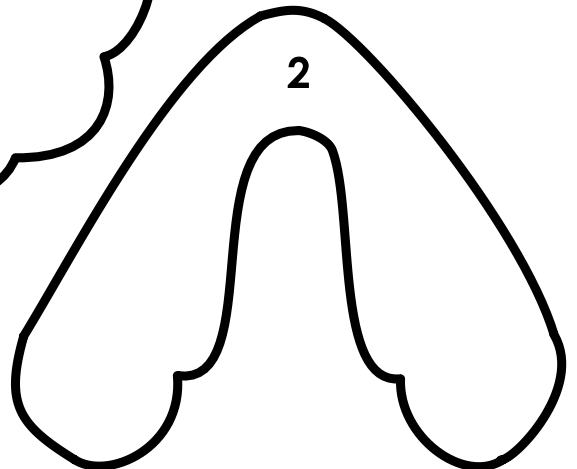

2

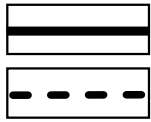

CUT ALONG THE LINE



CUT

GLUE



COLOR

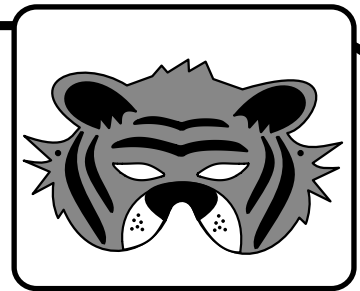

TIGER

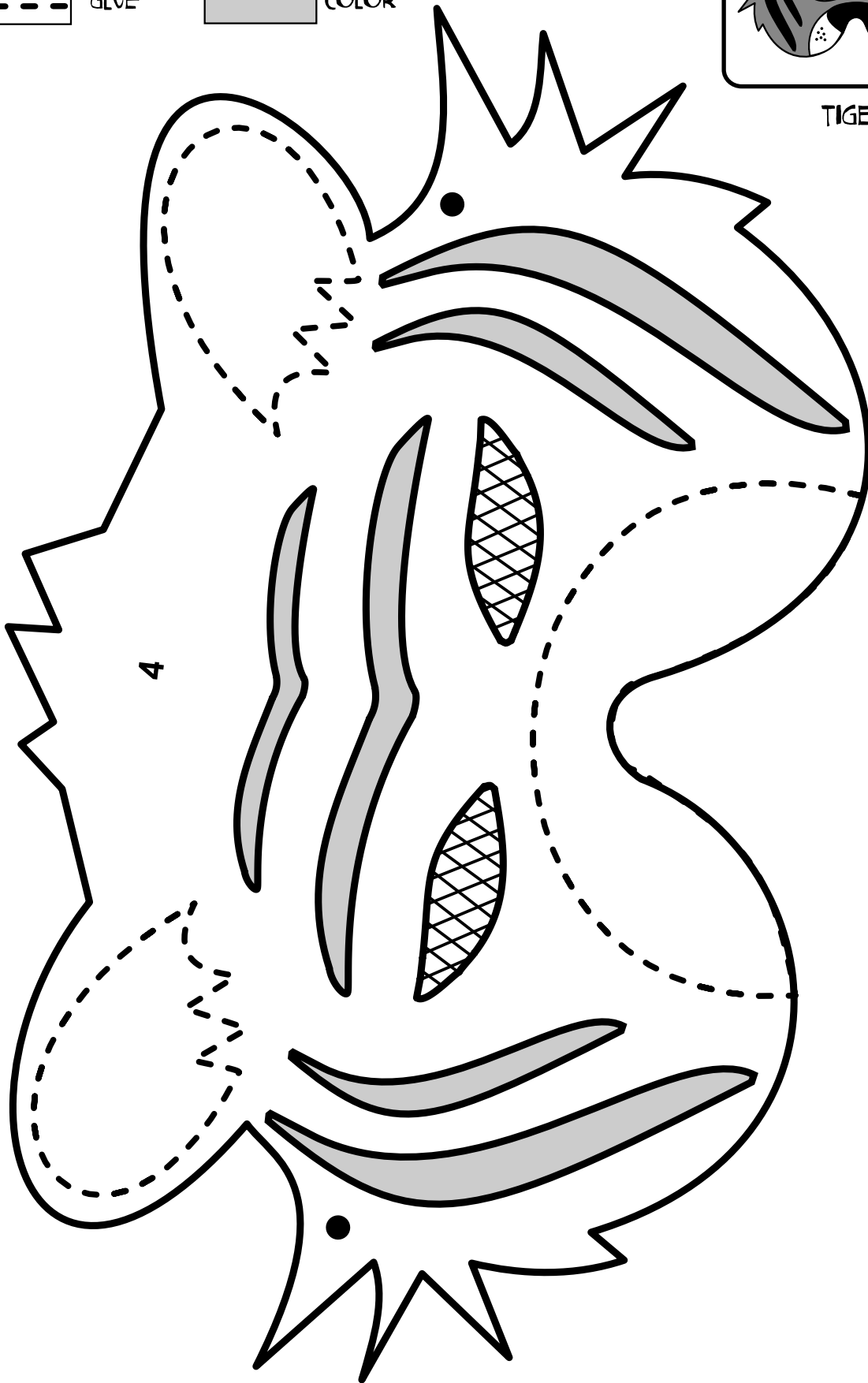

USE ADDITIONAL PIECES FROM PAGE 118. COLOR ALL SHADED AREAS. USE COLOR CODE 1.

TIGER PATTERNS

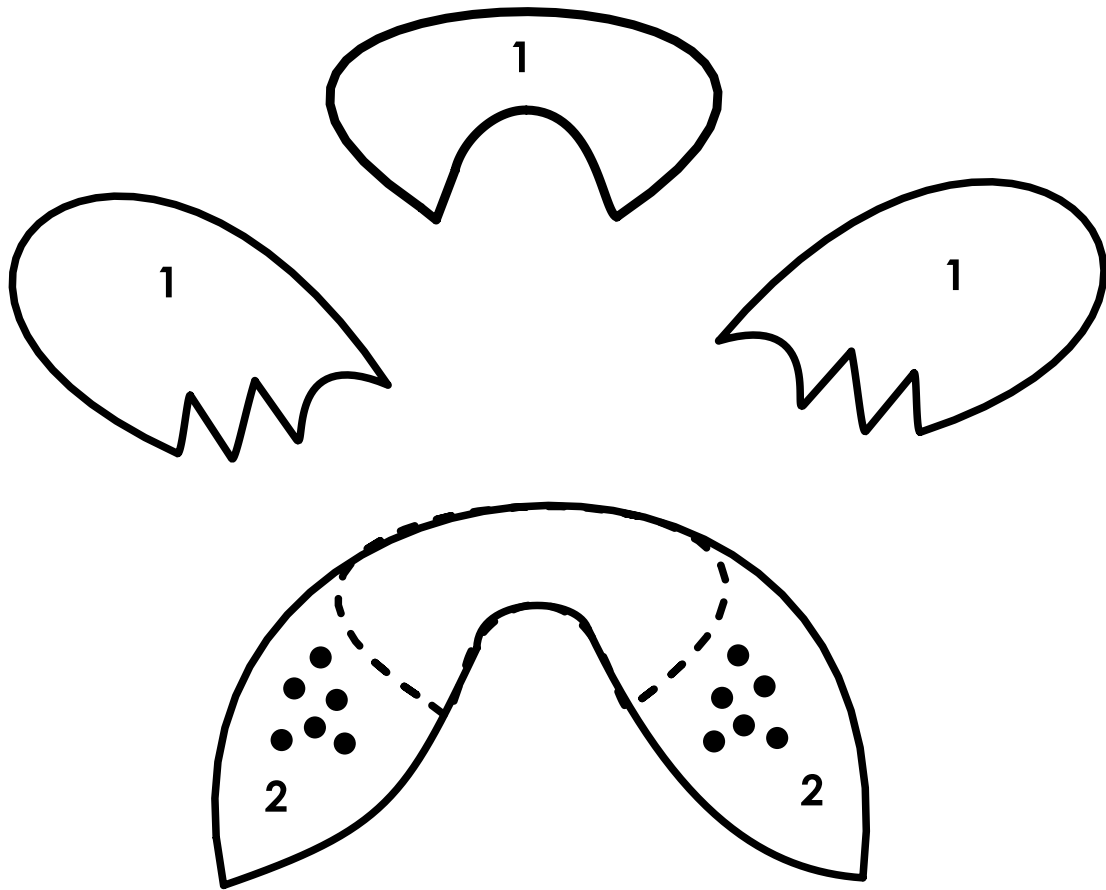

USE WITH MASK PATTERN ON PAGE 117.

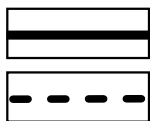

CUT ALONG THE LINE



CUT

GLUE



COLOR



ZEBRA

USE ADDITIONAL PIECES FROM PAGE 120. COLOR ALL SHADED AREAS. USE COLOR CODE 1.

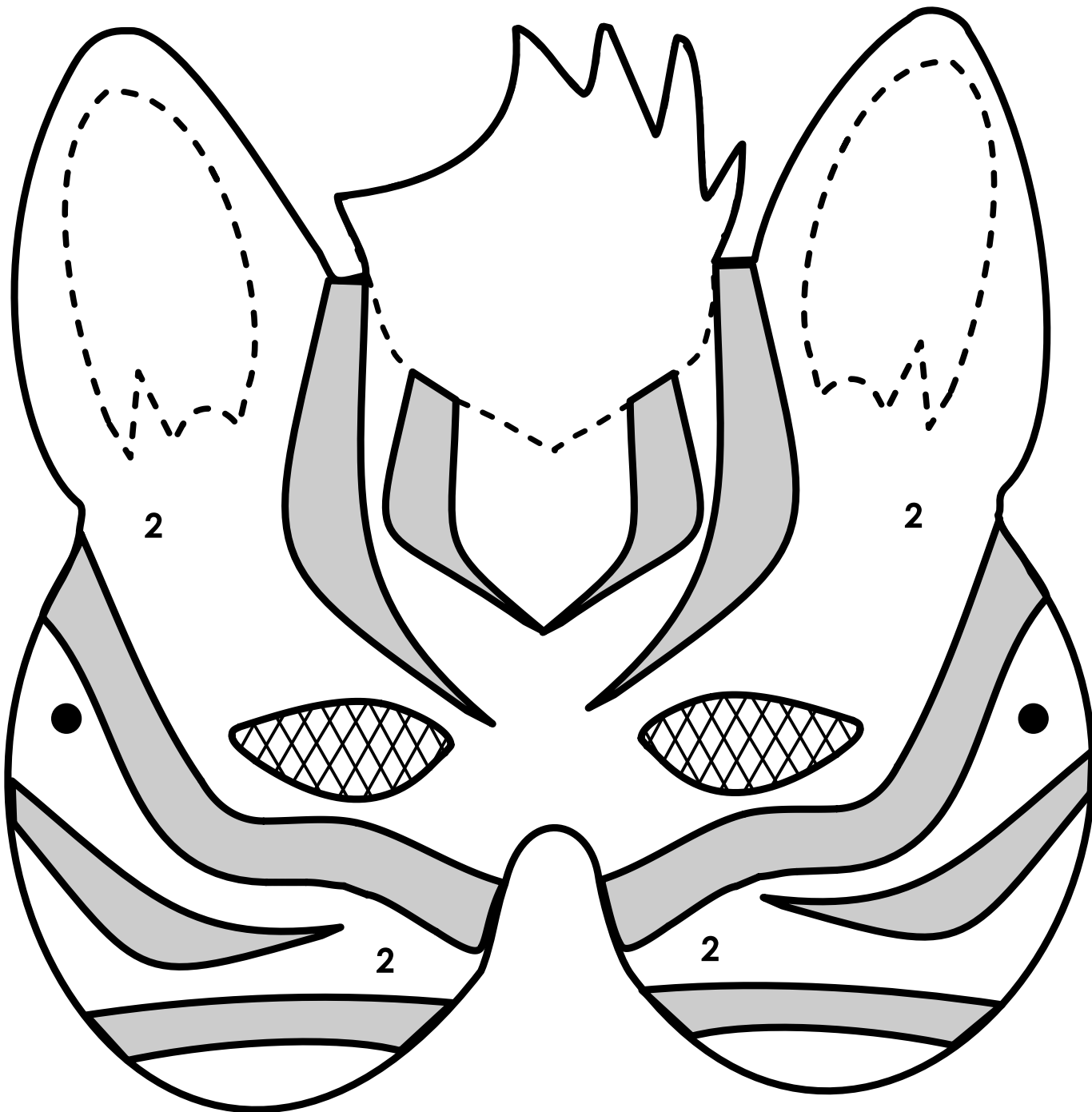

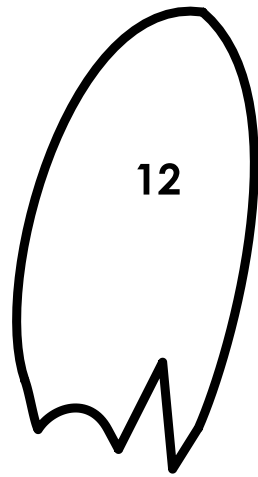
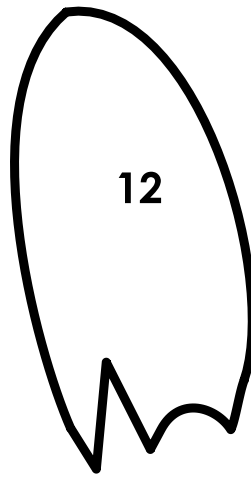
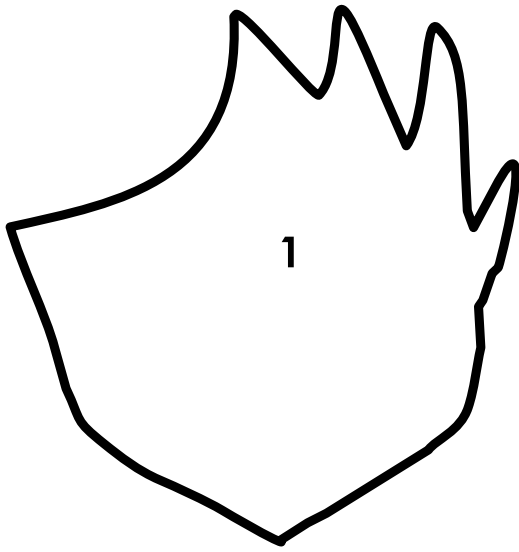

USE WITH MASK PATTERN ON PAGE 119.

MOBILES

BALLOON MOBILE



MATERIALS

- 6 different colored, letter sized cardboard sheets
- scissors
- paper fastener or brad
- yarn or string
- 1 clean milk carton bottom (6 cms. tall)
- paint
- paintbrush
- balloon mobile pattern (p. 125)
- tape

INSTRUCTIONS

1. Use the template to trace the figure 5 times onto different colored cardboard.
2. Make a hole with the tip of a pencil on each figure at the hole mark.
3. Join all the pieces by putting a paper fastener through the holes.
4. Fan out the pieces to look like an asterisk. (see fig. 1)
5. Turn over.
6. Take 2 adjacent sections and tape the ends side to side. (see fig. 2)
7. Take the next adjoining section and tape it in place.
8. Continue taping the rest of the pieces so that a balloon shape emerges. (see fig. 3)

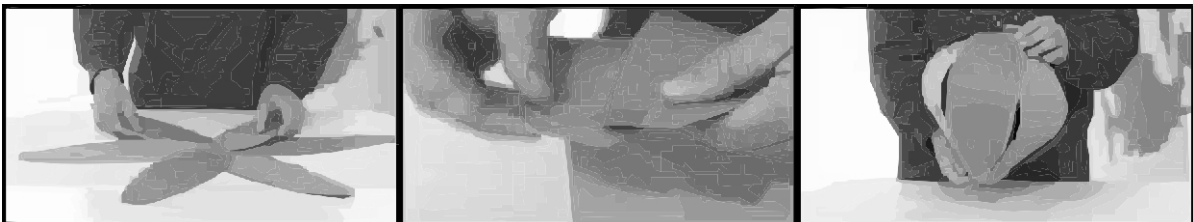

FIGURE 1

FIGURE 2

FIGURE 3

9. Cut 6 equal lengths of yarn or string and tape them on the inside of the balloon's bottom hole, where each section joins. (see fig. 4)
 10. Tape the other ends of the yarn to the milk carton bottom. (see fig. 5)
 11. Paint the milk carton bottom to look like a basket.
- * Tie a piece of yarn or string to the paper fastener at the top of the balloon and hang it.
 - * Make several balloons and hang them along with fiberfill "clouds", also hanging from yarn or string.
 - * Make cardboard people to ride in the balloon's basket.

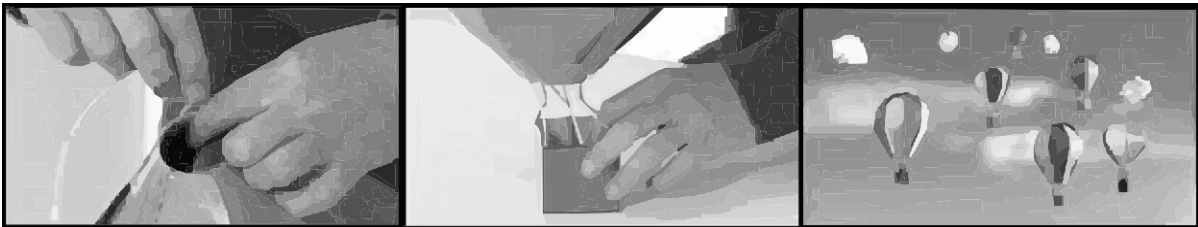

FIGURE 4

FIGURE 5

FINISH!

BALLOON MOBILE PATTERN



Cut along the solid line.

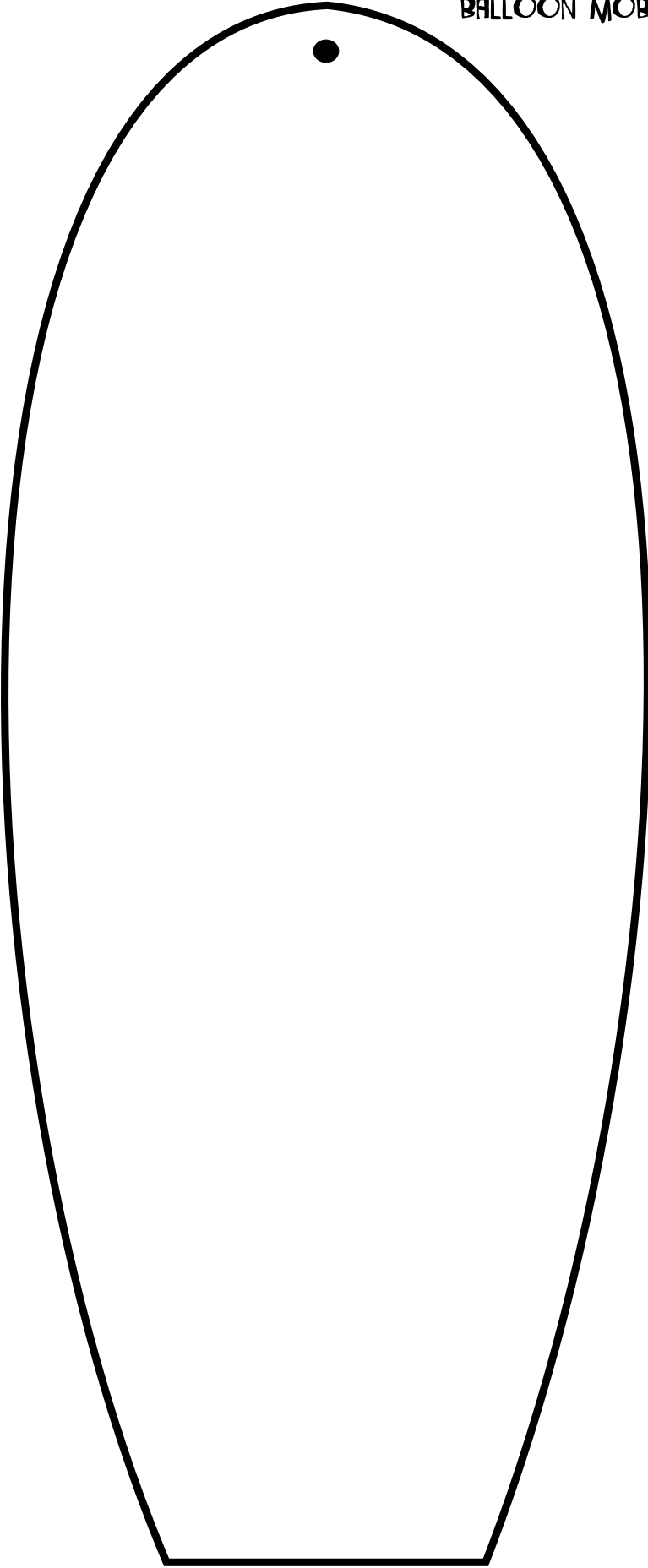

BREAKFAST MOBILE

MATERIALS

- 2 sets of figure patterns for each mobile (pp. 127, 128)
- cardboard (folder, cereal box)
- glue
- colors, crayons, markers
- string or yarn
- hole punch
- plastic lid (1 lt. container),
- clothes hanger, or paper plate

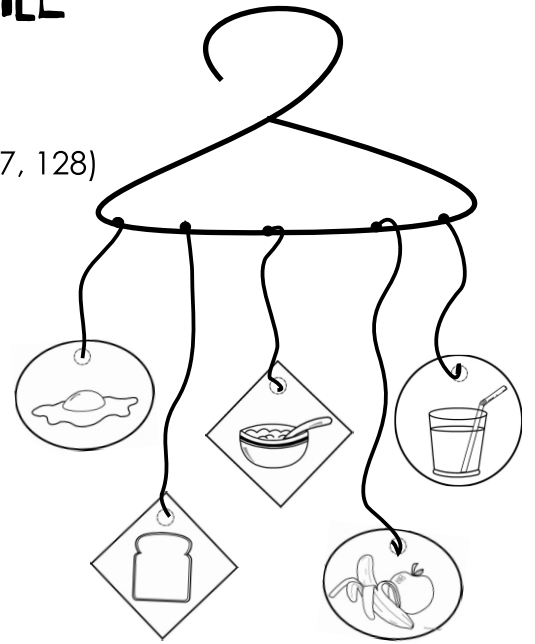

INSTRUCTIONS

1. Color and decorate the figures.
2. Glue one set onto the cardboard and cut out along the solid line.
3. Cut out the second set and glue onto the back of the first set.
4. Punch holes at the hole marks.
5. If you use a plastic lid or paper plate, punch holes on it to tie the yarn or string. If not, tie the figures onto a hanger.

BREAKFAST MOBILE PATTERNS

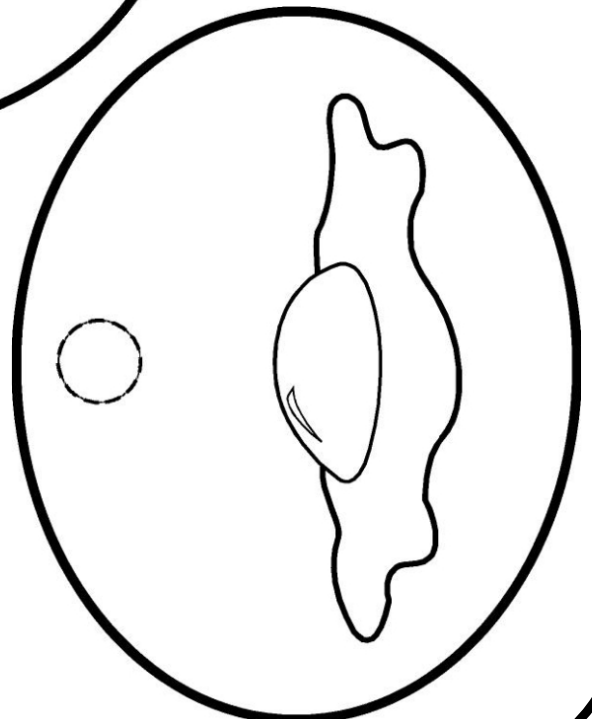
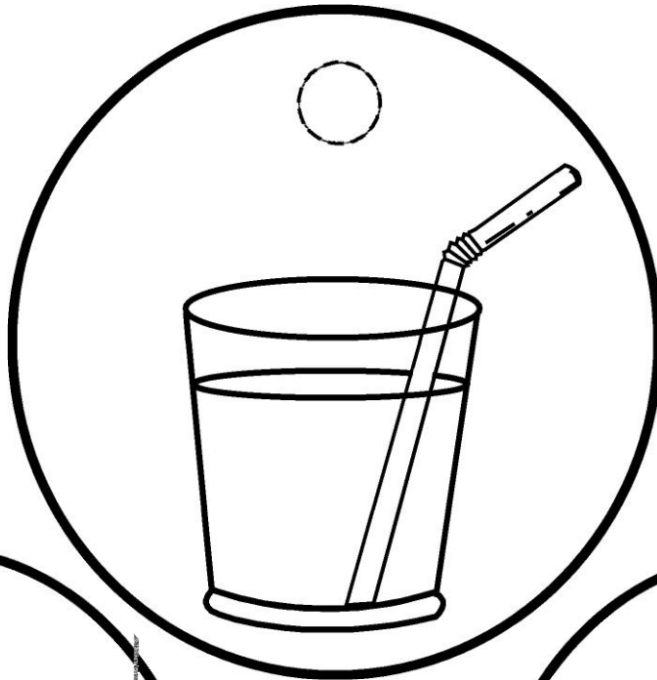
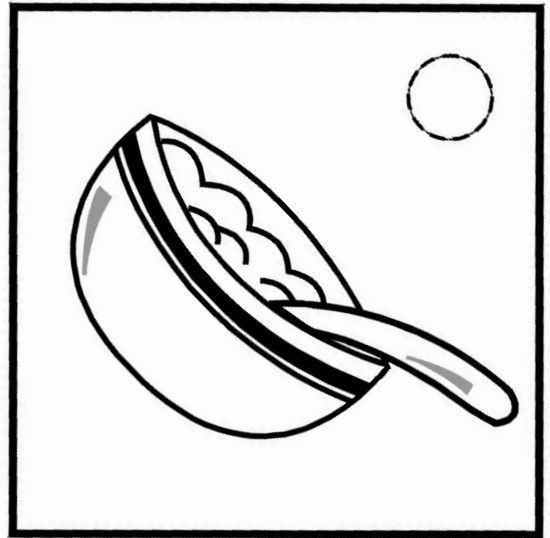
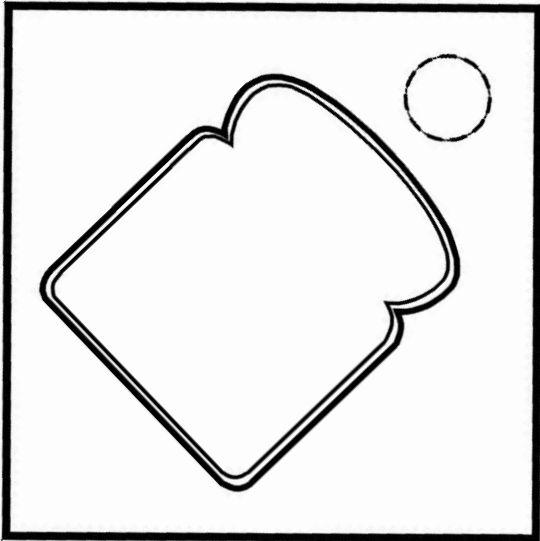

BREAKFAST MOBILE PATTERNS

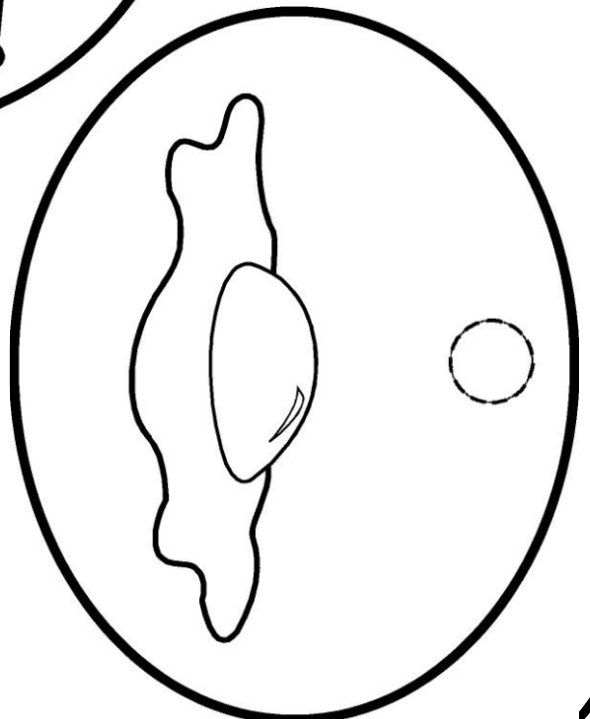
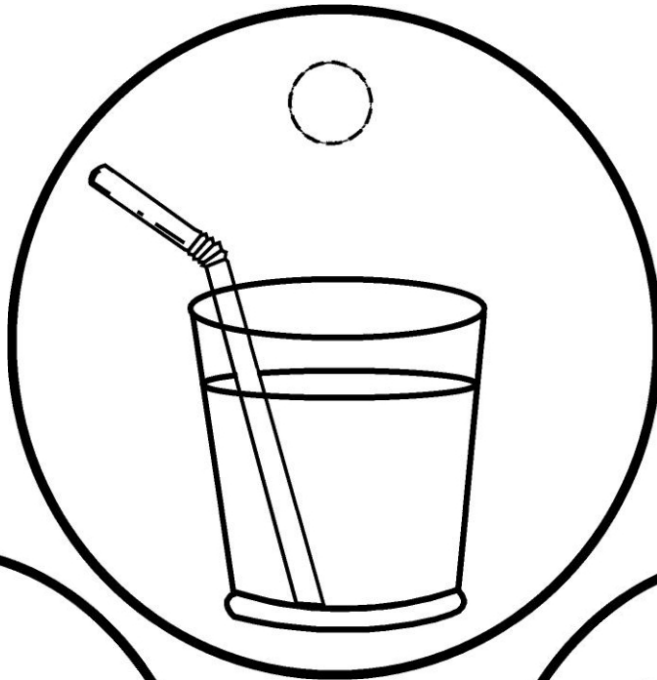
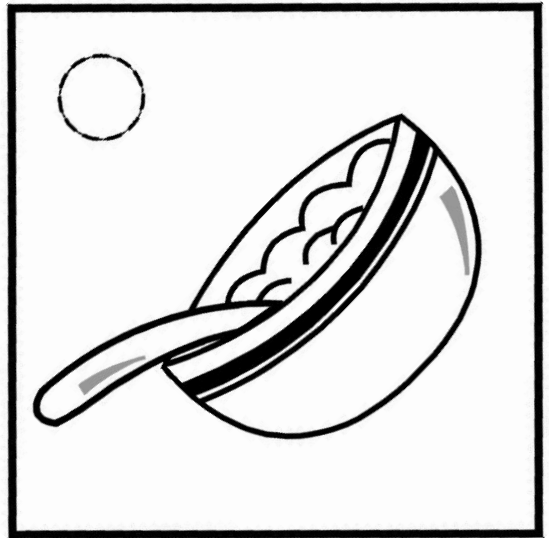
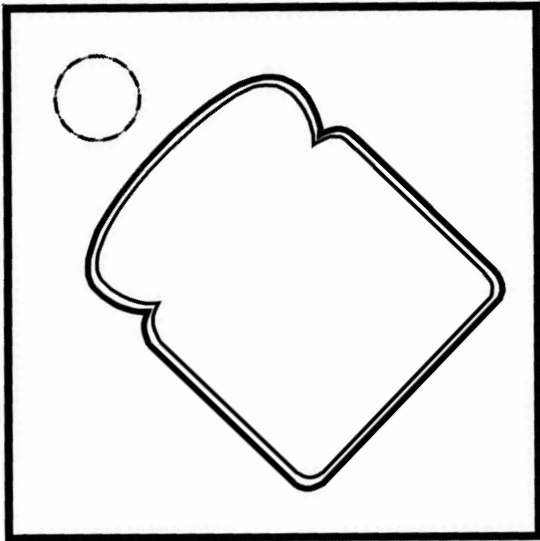

BUTTERFLY MOBILE

MATERIALS

- patterns (p. 130)
- 50 cm. long craft stick
- 3 straws
- colored yarn
- paper
- 6 cotton swabs
- crayons, colors, markers
- 6 twist ties
- scissors
- ruler



INSTRUCTIONS

1. Trace the butterfly patterns twice onto the paper. (You should have 6 butterflies.)
2. Cut out and color on both sides. Make small slits where indicated. (see fig. 1)
3. Thread the cotton swabs through the slits in the wings to make the butterfly's body. (see fig. 2)
4. Bend the twist ties in half and twist around the cotton swabs to make antennae. Curl the ends with your fingers. (see fig. 3)
5. Cut six 20 cm. long pieces of yarn. Tie one end to the wire antennae. Tie the other end to the last slit in the wing. (see fig. 4) Repeat with all butterflies.
6. Cut 2.5 cm. slits on each end of the straws. Slide the butterfly yarns onto the straws. (see fig. 5)
7. Cut different lengths of yarn and tie the straws to the craft stick. (see example)

BREAKFAST MOBILE PATTERN

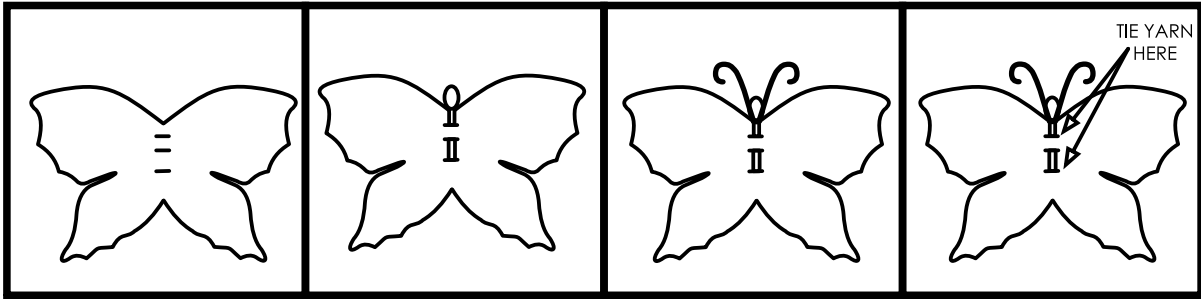

FIGURE 1

FIGURE 2

FIGURE 3

FIGURE 4

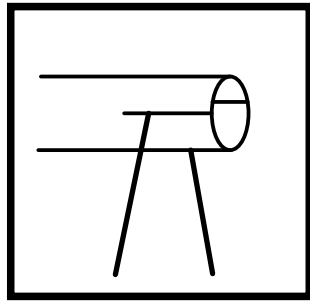
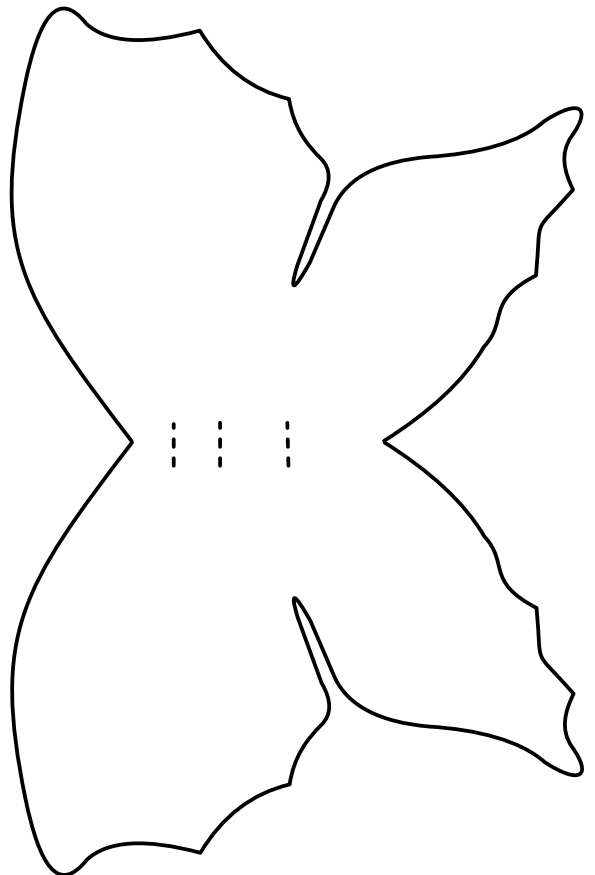
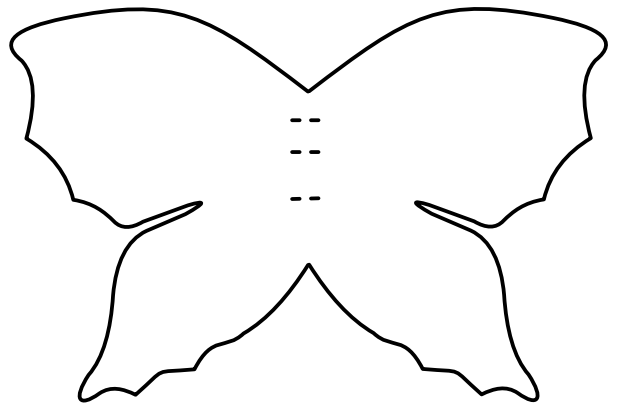
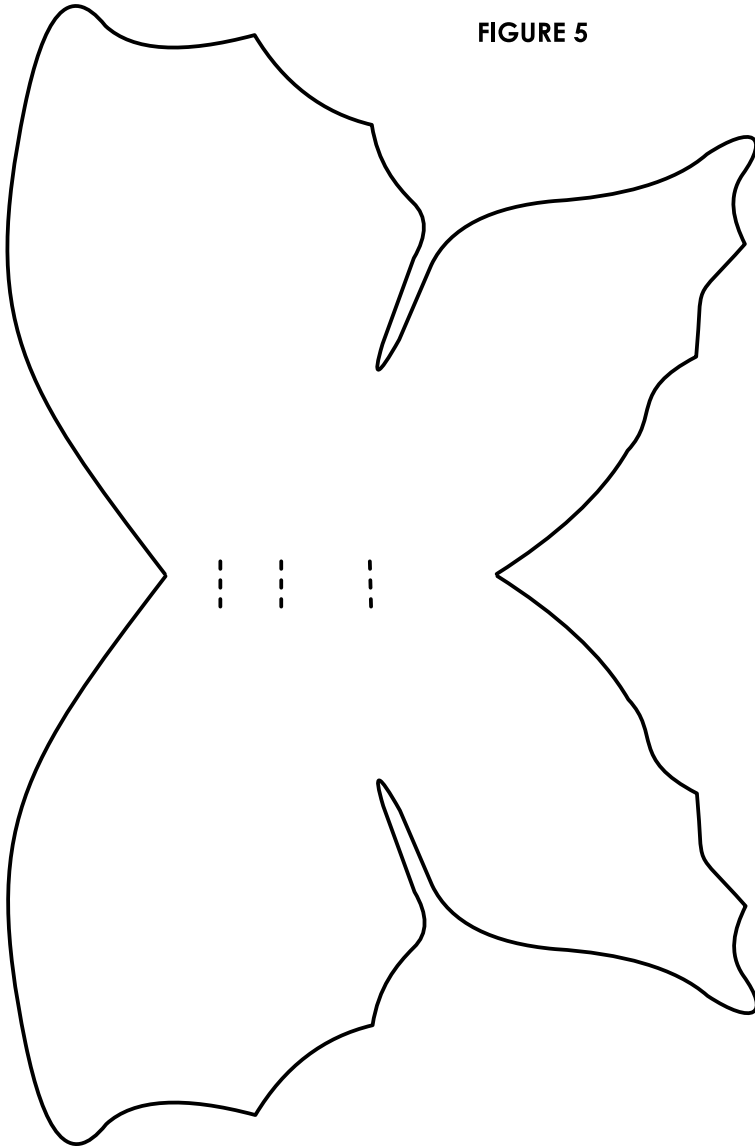

FIGURE 5



CHRISTMAS MOBILE

MATERIALS

- pattern (p. 132)
- colors, markers, crayons
- cardboard (folder)
- scissors
- glue
- yarn
- hole punch



INSTRUCTIONS

1. Glue the pattern onto the cardboard. Color and cut out.
2. Punch a hole at the marks.
3. Cut strips of yarn 7 cms. long. Tie one end to a piece, and the other to another piece to make the tree shape. (see example)
4. Cut a 30 cm. long piece of yarn and tie to the top of the tree to hang.

CHRISTMAS MOBILE PATTERNS

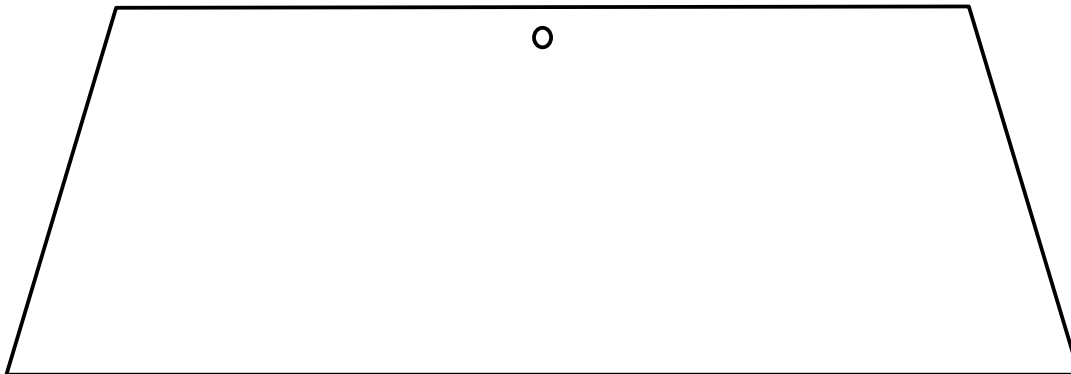
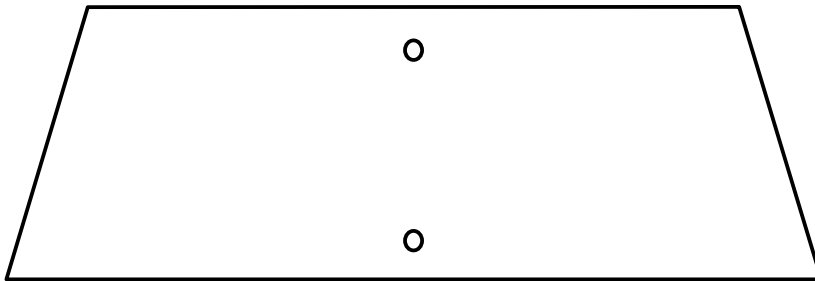
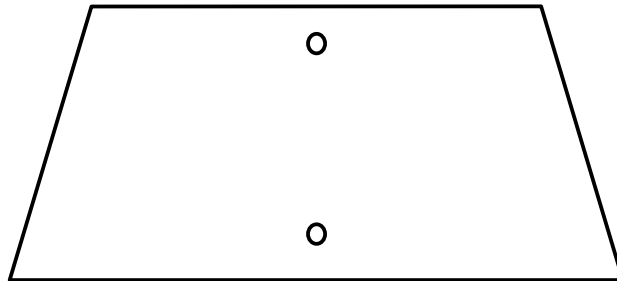
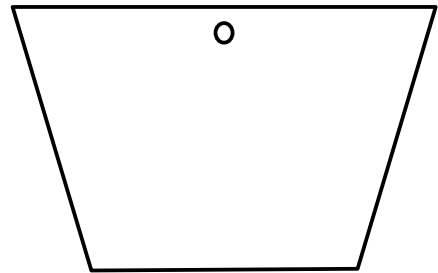
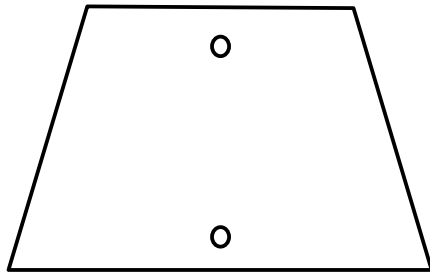
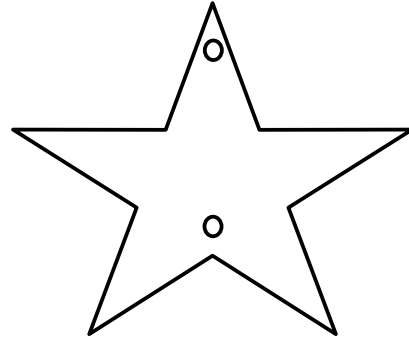
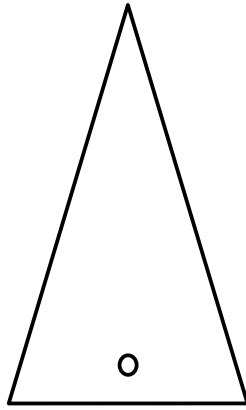

COSMICALLY COOL MOBILE

MATERIALS

- cardboard or posterboard (1 letter size sheet)
- aluminum foil
- glue / tape
- scissors
- tinsel
- string or yarn
- yellow paint
- paintbrush
- cool mobile patterns (pp. 134, 135)

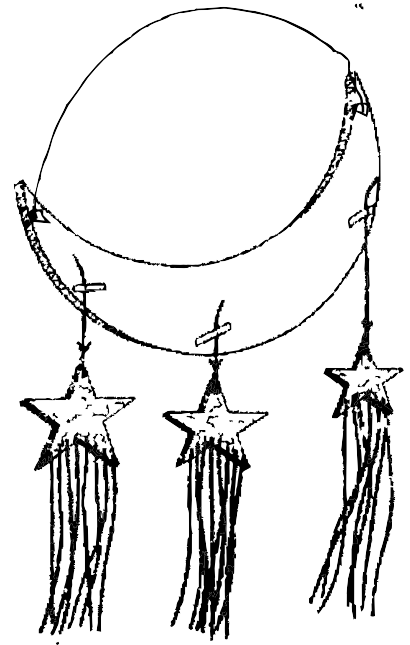

INSTRUCTIONS

1. Glue the patterns onto the cardboard and cut out along the solid line.
2. Trace the star shapes twice (each) onto the aluminum foil and cut out.
3. Glue the foil shapes onto the stars on both sides.
4. Paint the moon yellow.
5. Glue the tinsel to the bottom of the stars. (see example)
6. Tape or glue yarn or string from each star to the moon.
7. Glue or tape a long piece of yarn to each tip of the moon to hang.

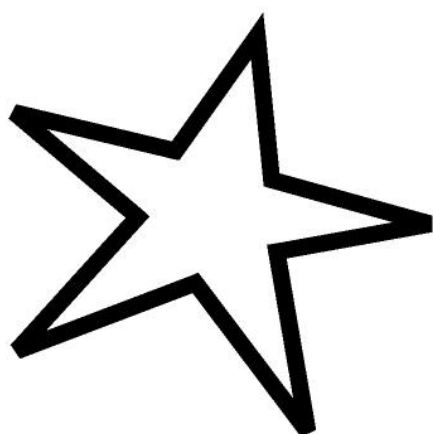
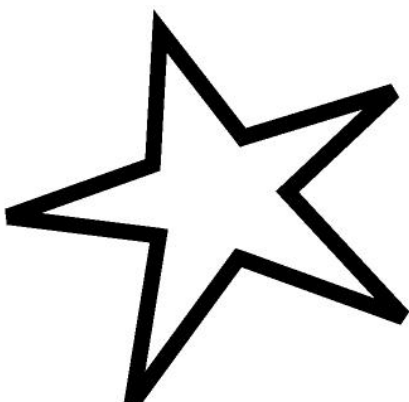
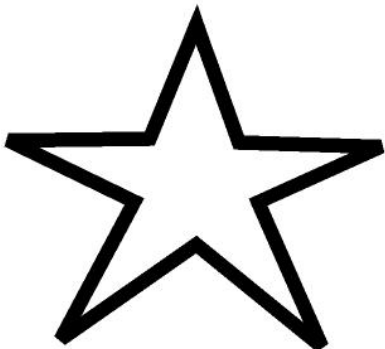
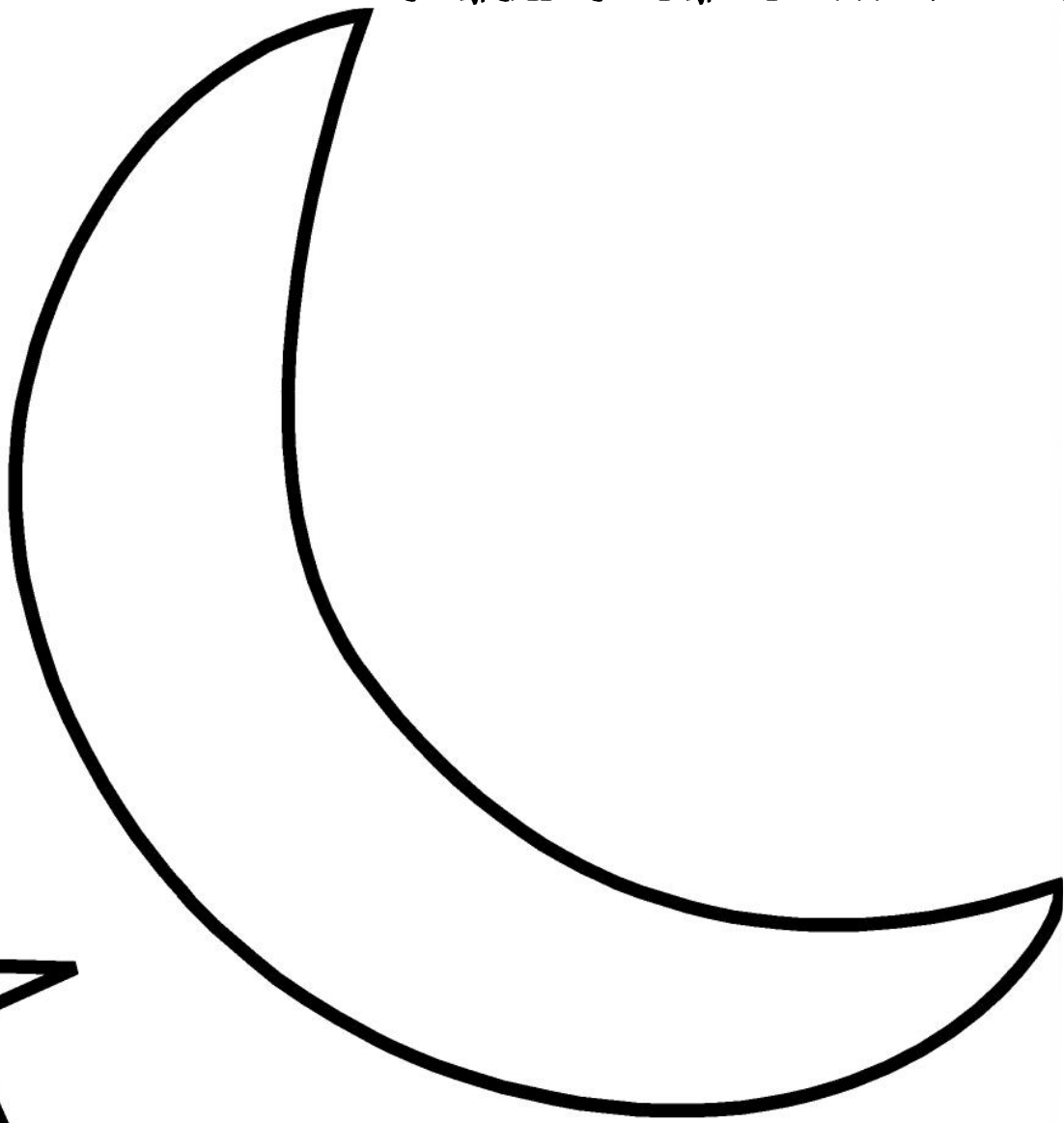

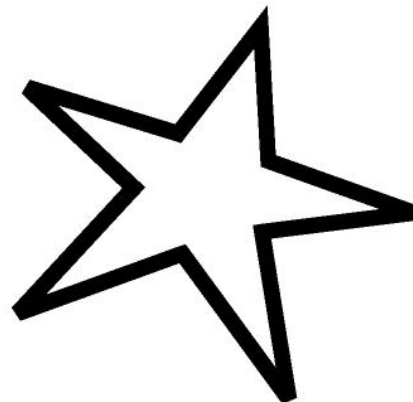
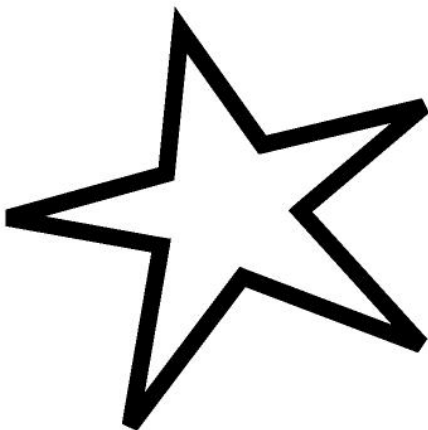
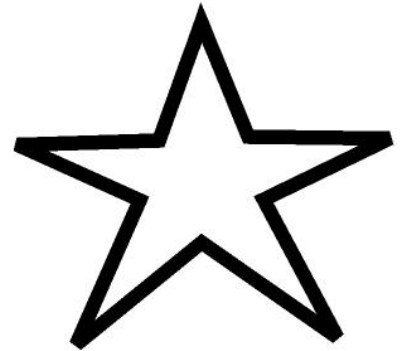
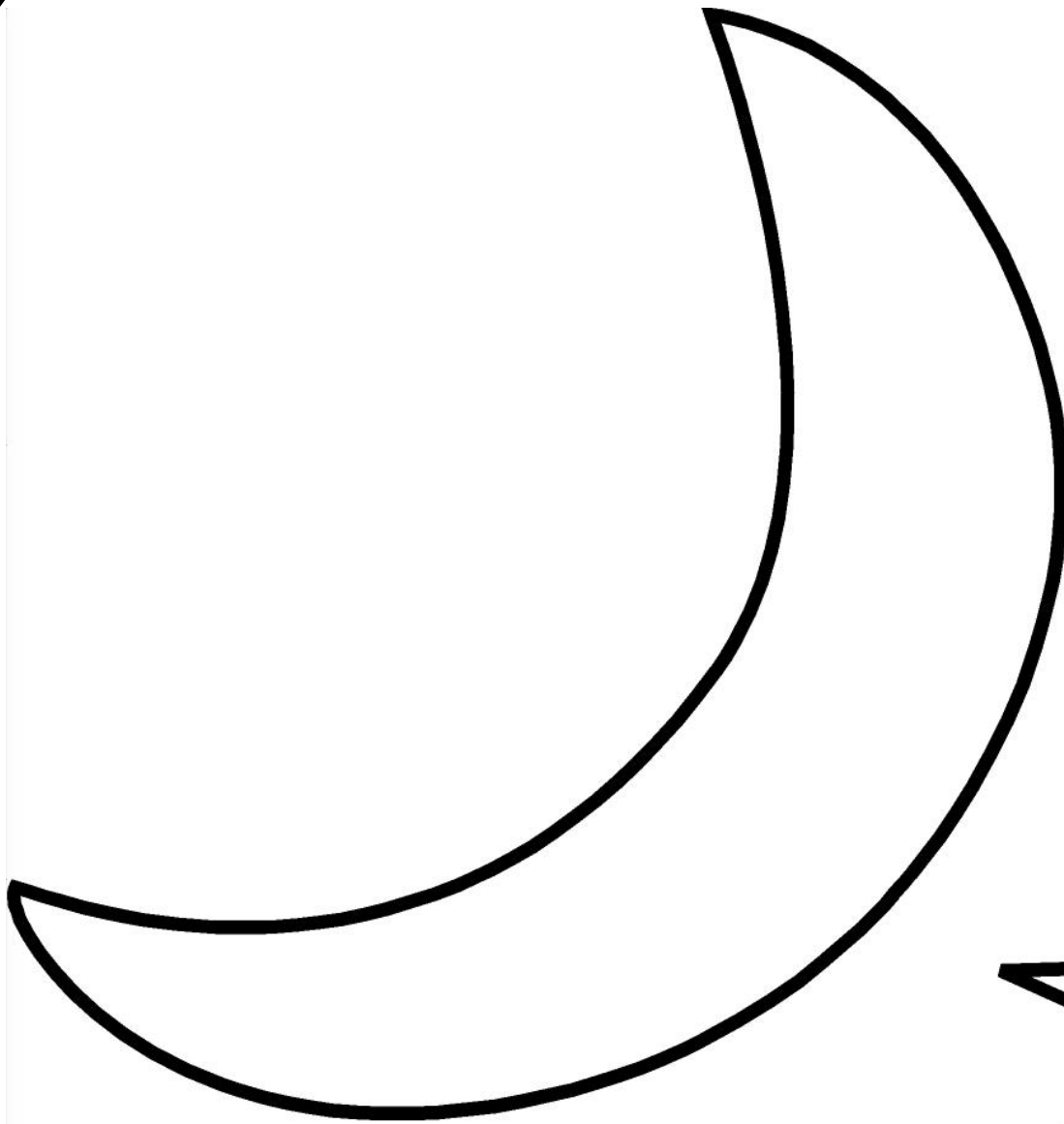

DENTAL HEALTH MOBILE

MATERIALS

- figure patterns (pp. 137, 138)
- cardboard (folder, cereal box)
- glue
- colors, crayons, markers
- string or yarn
- hole punch
- plastic lid (1 lt. container),
- clothes hanger, or paper plate

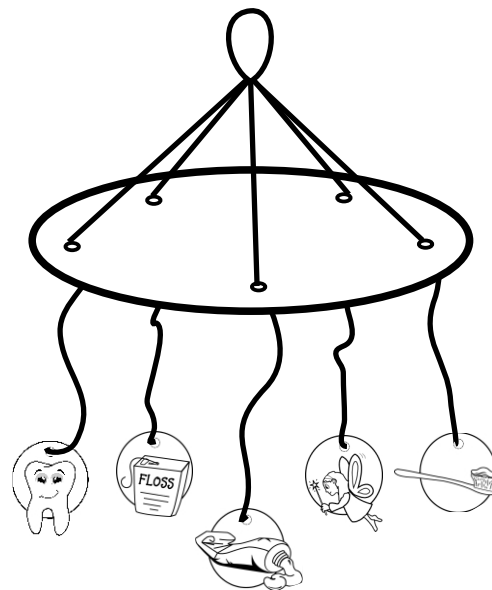

INSTRUCTIONS

1. Color and decorate the figures.
2. Glue one set onto the cardboard and cut out along the solid line.
3. Cut out the second set and glue onto the back of the first set.
4. Punch holes at the hole marks.
5. If you use a plastic lid or paper plate, punch holes on it to tie the yarn or string. If not, tie the figures onto a hanger.

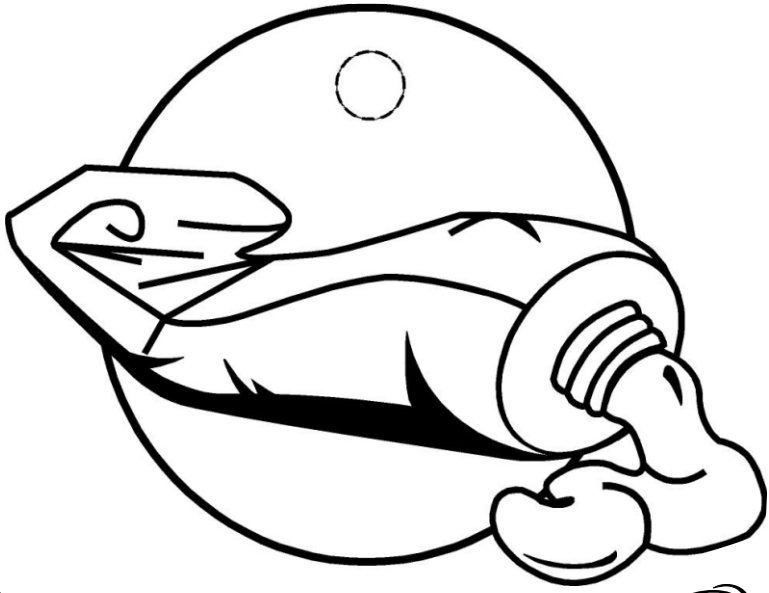
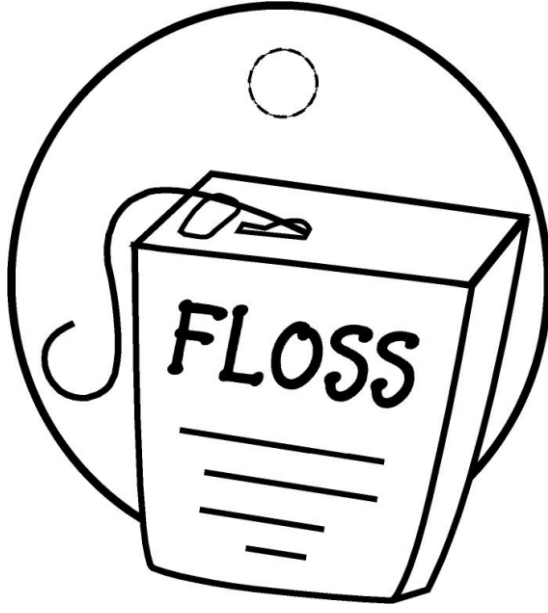
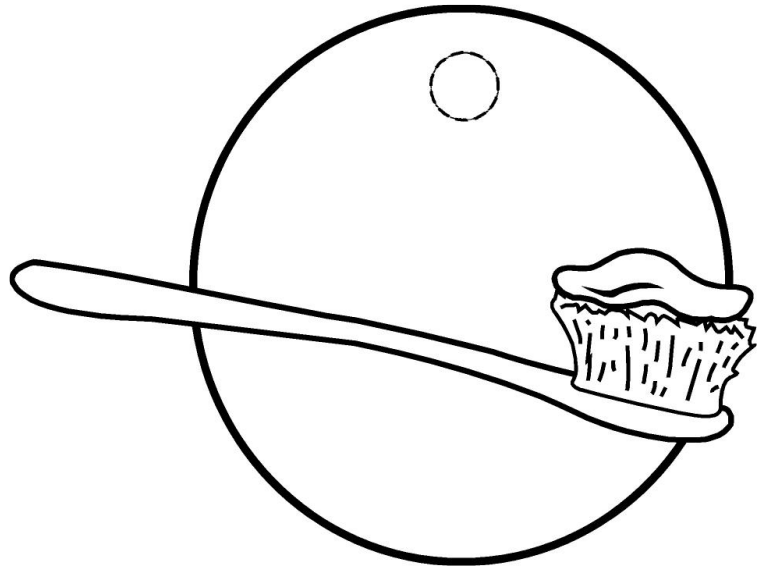
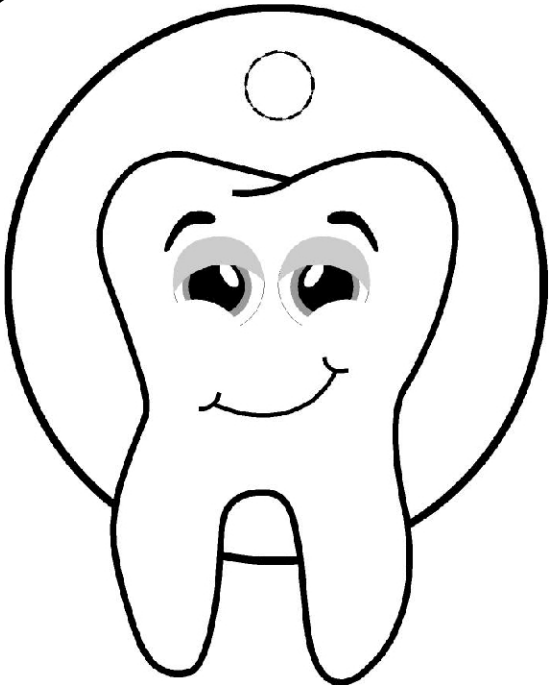

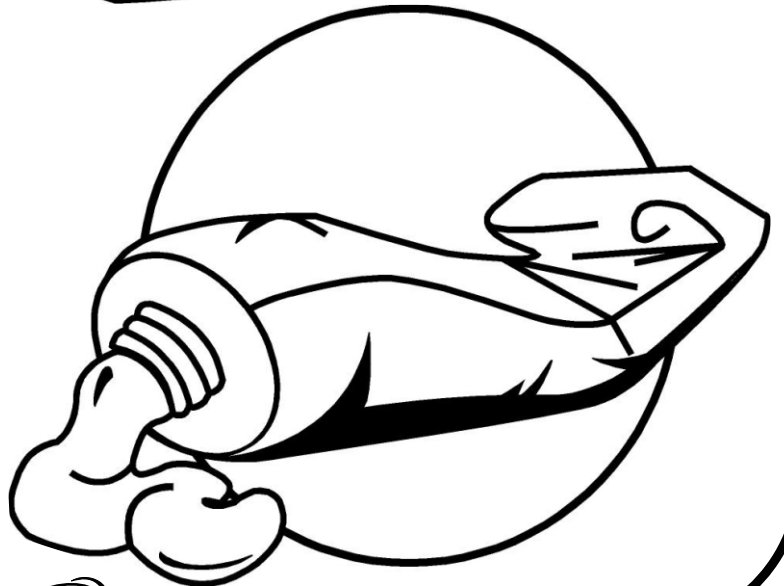
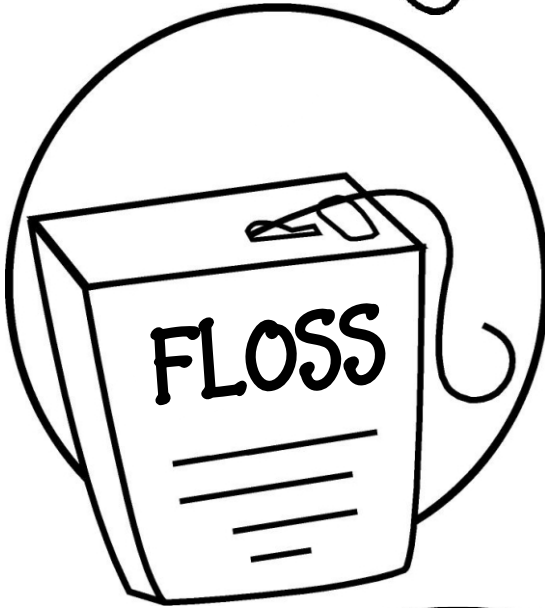
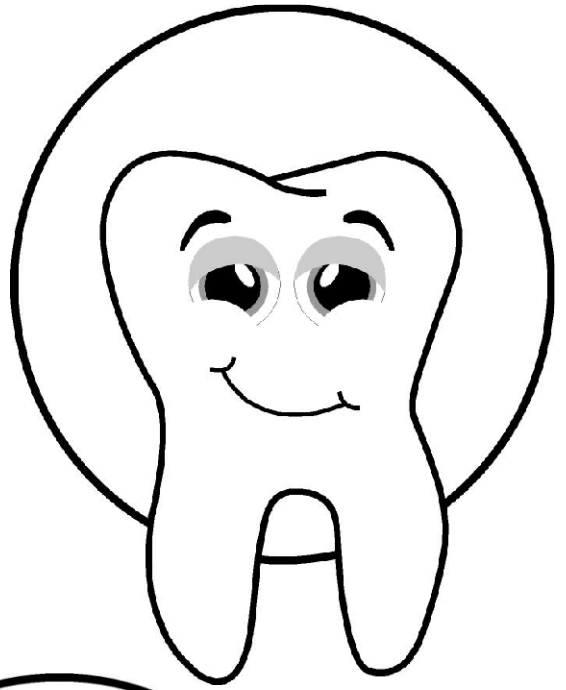
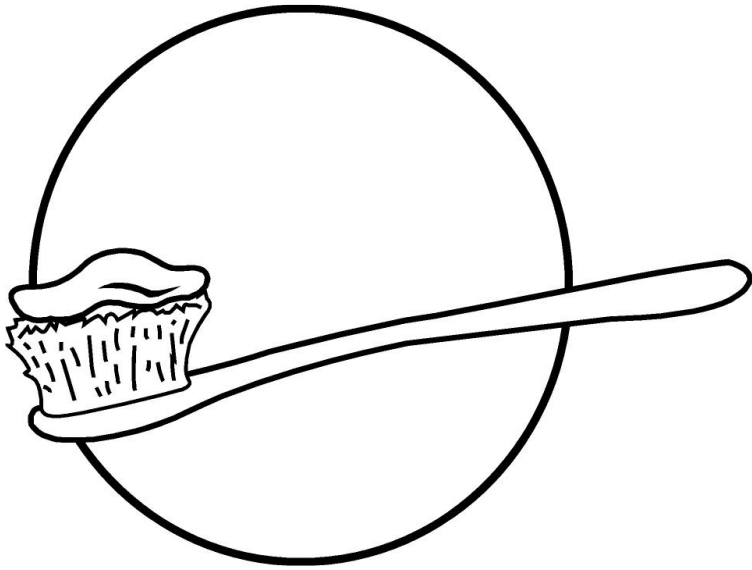

EGG CARTON BUGGY MOBILE

MATERIALS

- 8 egg carton cups
- 4 medium pom-poms
- 4 pairs of small googly eyes
- 2 black pipe cleaners (cut in half)
- wrapping paper
- yarn
- glue
- scissors
- wire hanger
- paint (assorted colors)



INSTRUCTIONS

1. Paint the egg carton cups in pairs.
2. Fold the wrapping paper in half, and glue; so you have print on both sides.
3. Cut 8 circles from the wrapping paper. These will be wings.
4. Glue 2 circles on the open end of an egg carton cup. (see fig. 1)
5. Glue a length of yarn between the 2 wings. (see fig. 2)
6. Glue a second egg carton cup on top of the first one, to make the bug's body. (see fig. 3)
6. Glue one pom-pom on the bug's body to make a head. (see fig. 4)
7. Fold a pipe cleaner piece in half and glue onto the pom-pom as antennae. Glue on googly eyes.
8. Repeat to make 3 more bugs.
9. Tie the bugs at different heights on the hanger.

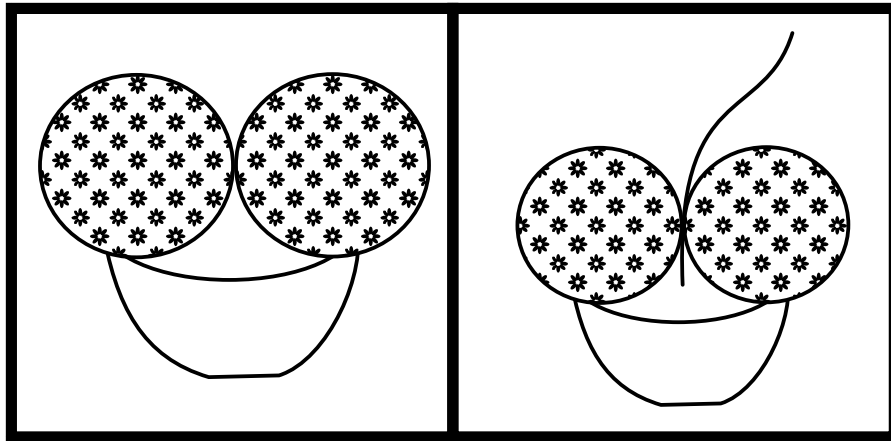

FIGURE 1

FIGURE 2

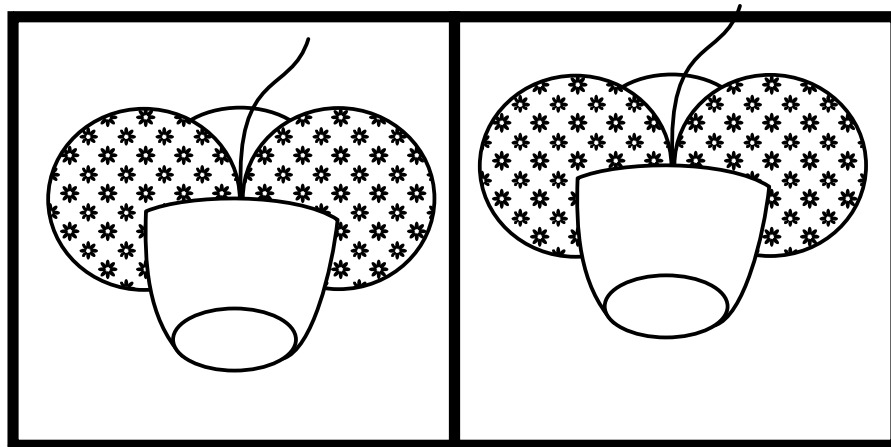

FIGURE 3

FIGURE 4

FALL LEAVES MOBILE

MATERIALS

- pattern (p. 142)
- paper plate
- colors, crayons, markers
- scissors
- tape / glue
- yarn / string



INSTRUCTIONS

1. Cut out and color the patterns on both sides.
2. Color the paper plate on both sides, and cut in a spiral shape. (see example)
3. Cut several 7 cm. long string pieces.
4. Glue / tape one end of a string piece to a small leaf, and the other end to a big leaf.
5. Glue / tape the small leaves around the spiral. (see example)
6. Cut a 30 cm. long piece of string to hang the spiral from. (see example)

FALL LEAVES MOBILE PATTERNS

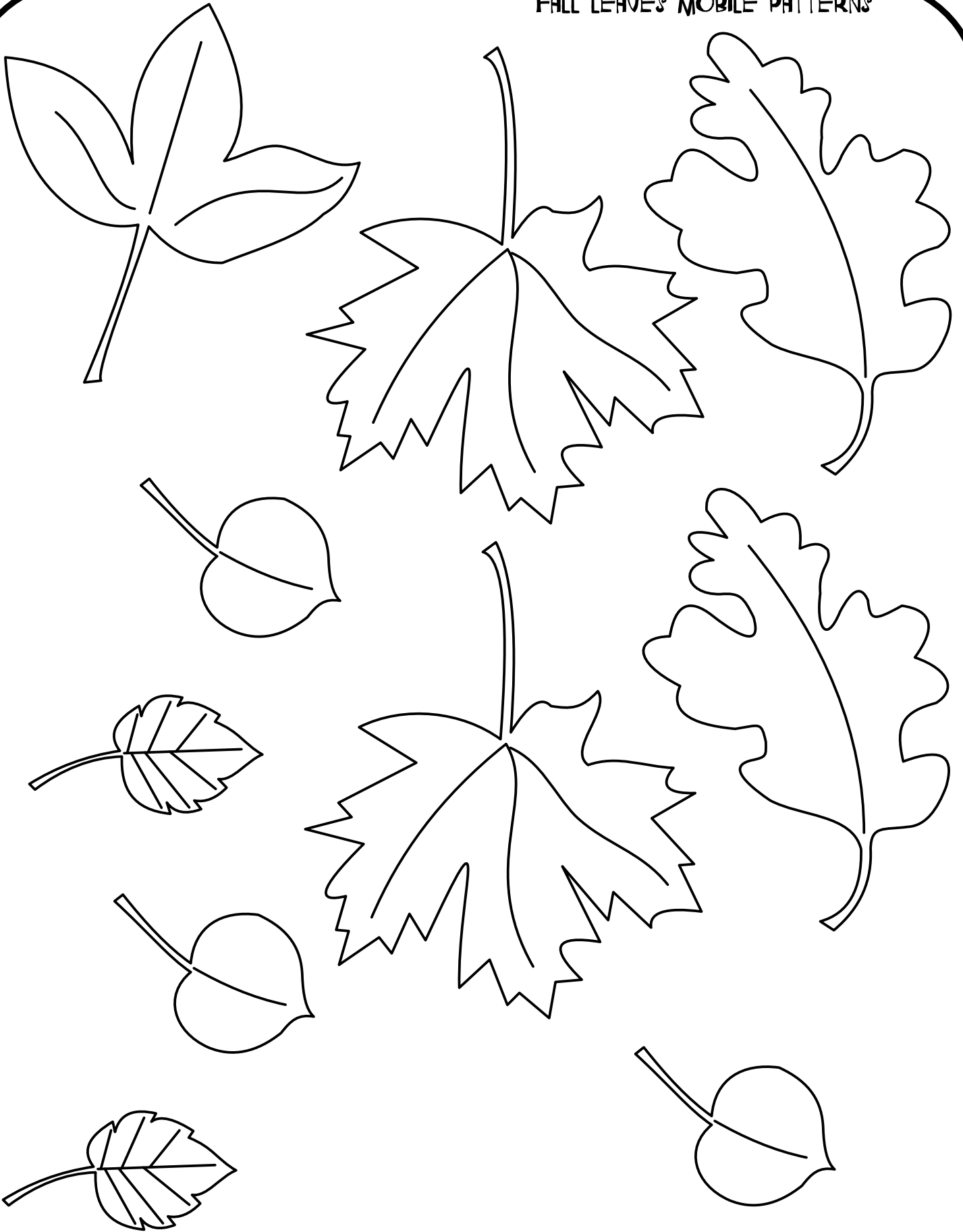

FLOATING HOT-AIR BALLOONS MOBILE

MATERIALS

- 4 paper plates
- paint
- scissors
- yarn
- hole punch



INSTRUCTIONS

1. Paint the first paper plate blue to make a sky. Let dry.
2. Cut or tear out holes to resemble clouds on the blue paper plate. (see example)
3. Cut the rim off the remaining paper plates, leaving only the center circle. (see fig. 1)
4. Paint and decorate 2 circles to resemble balloons. Let dry.
5. Paint remaining circle. Let dry. Cut or tear in half to make balloon baskets.
6. Punch 2 holes on the top of the balloon baskets. (see fig. 2)
7. Punch 2 holes on each balloon and use yarn to tie to baskets. (see fig. 3)
8. Punch 1 hole at the top of each balloon.
9. Punch 2 holes on the sky paper plate. Use yarn to tie balloons to the sky. (see fig. 4)
10. Punch a hole at the top of the sky plate. Tie yarn and hang.

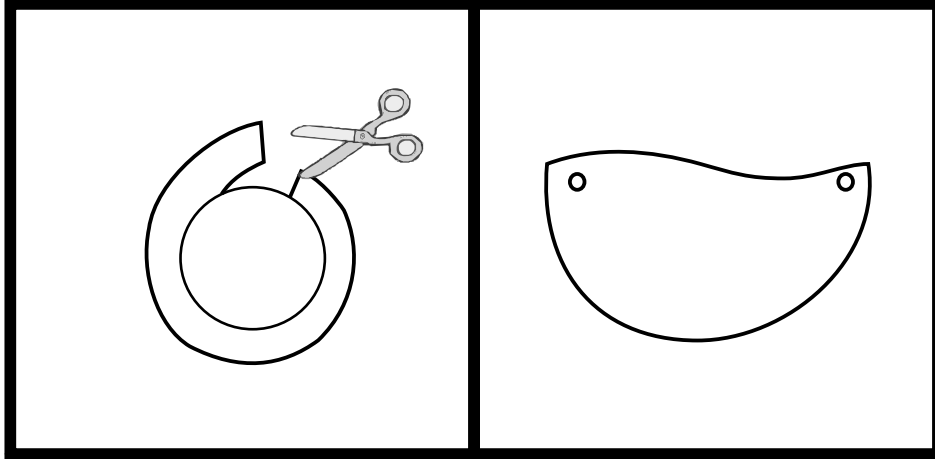

FIGURE 1

FIGURE 2

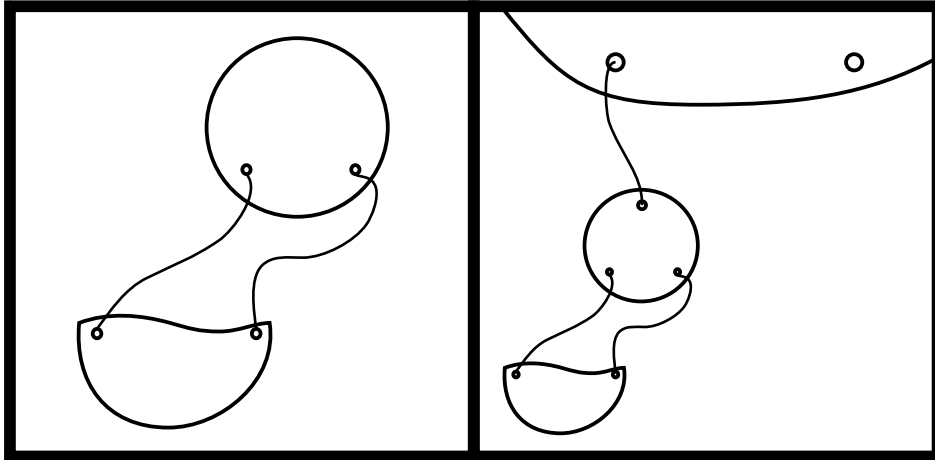

FIGURE 3

FIGURE 4

GEOMETRY MOBILE

MATERIALS

- patterns
- black construction paper
- colored tissue paper
- wire hanger
- scissors
- glue
- yarn
- hole punch

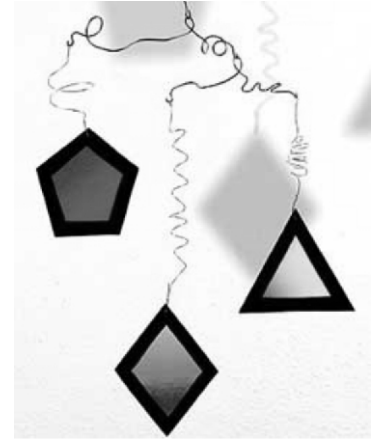

INSTRUCTIONS

1. Cut out and trace the patterns twice onto black construction paper. Cut out.
2. Glue a piece of tissue paper onto a construction paper shape. Glue the matching construction paper shape on top. (see fig. 1)
3. Repeat with all shapes.
4. Punch holes at the top of each shape.
5. Cut yarn in different lengths. Tie one end to a shape and the other to the hanger.

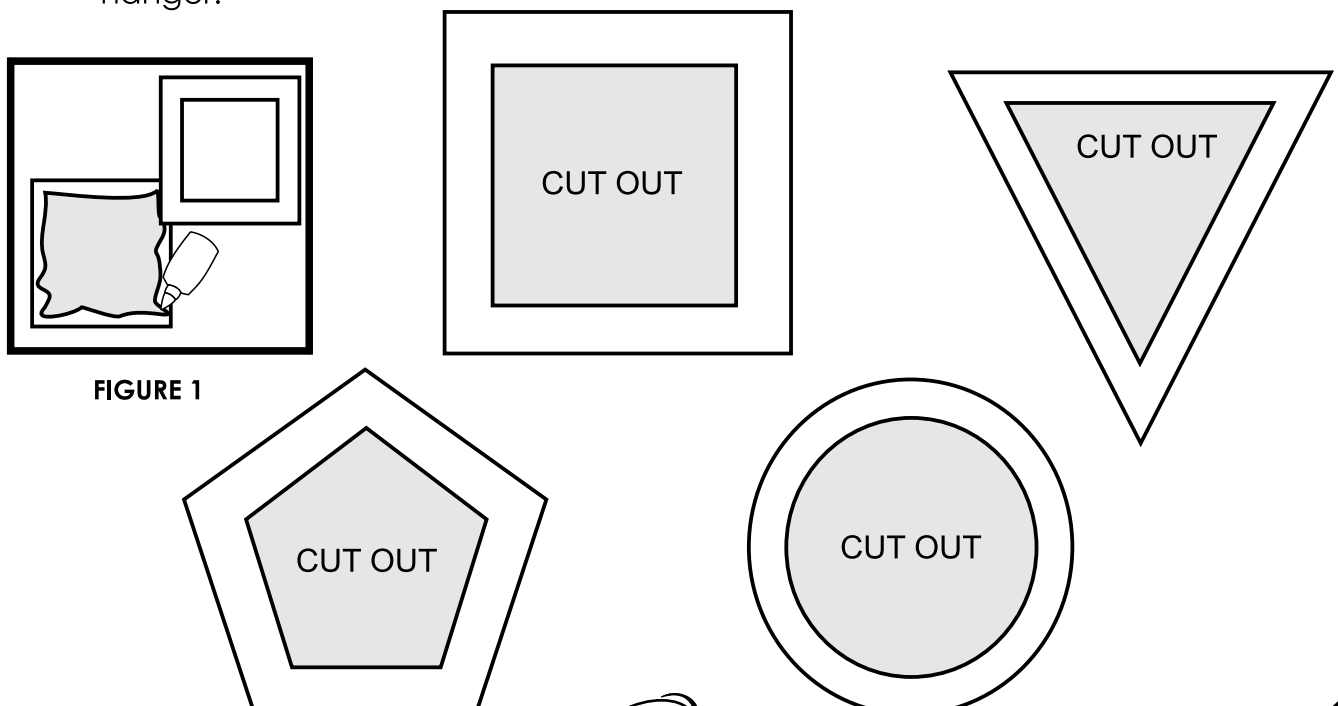
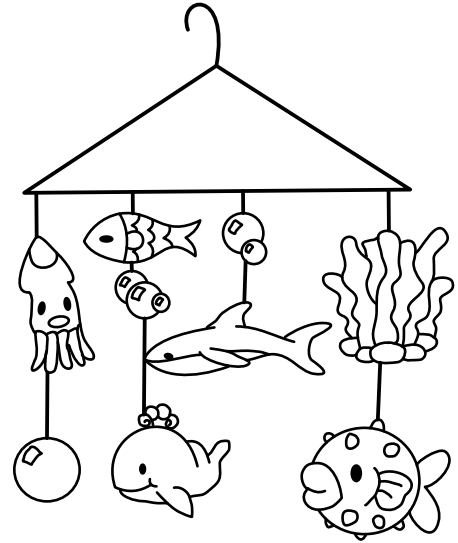

FIGURE 1

SEA MOBILE

MATERIALS

- patterns (pp. 147, 148)
- colors, markers, crayons
- wire hanger
- scissors
- glue
- yarn
- hole punch



INSTRUCTIONS

1. Color and cut out the patterns.
2. Glue the matching figures together. (see fig. 1)
3. Punch a hole on each figure.
4. Cut yarn in different lengths.
5. Tie one end of the yarn to a figure, and the other end to the hanger.

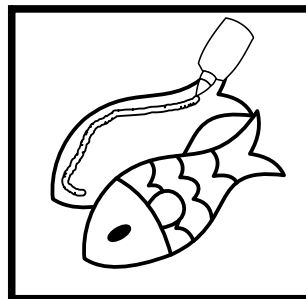
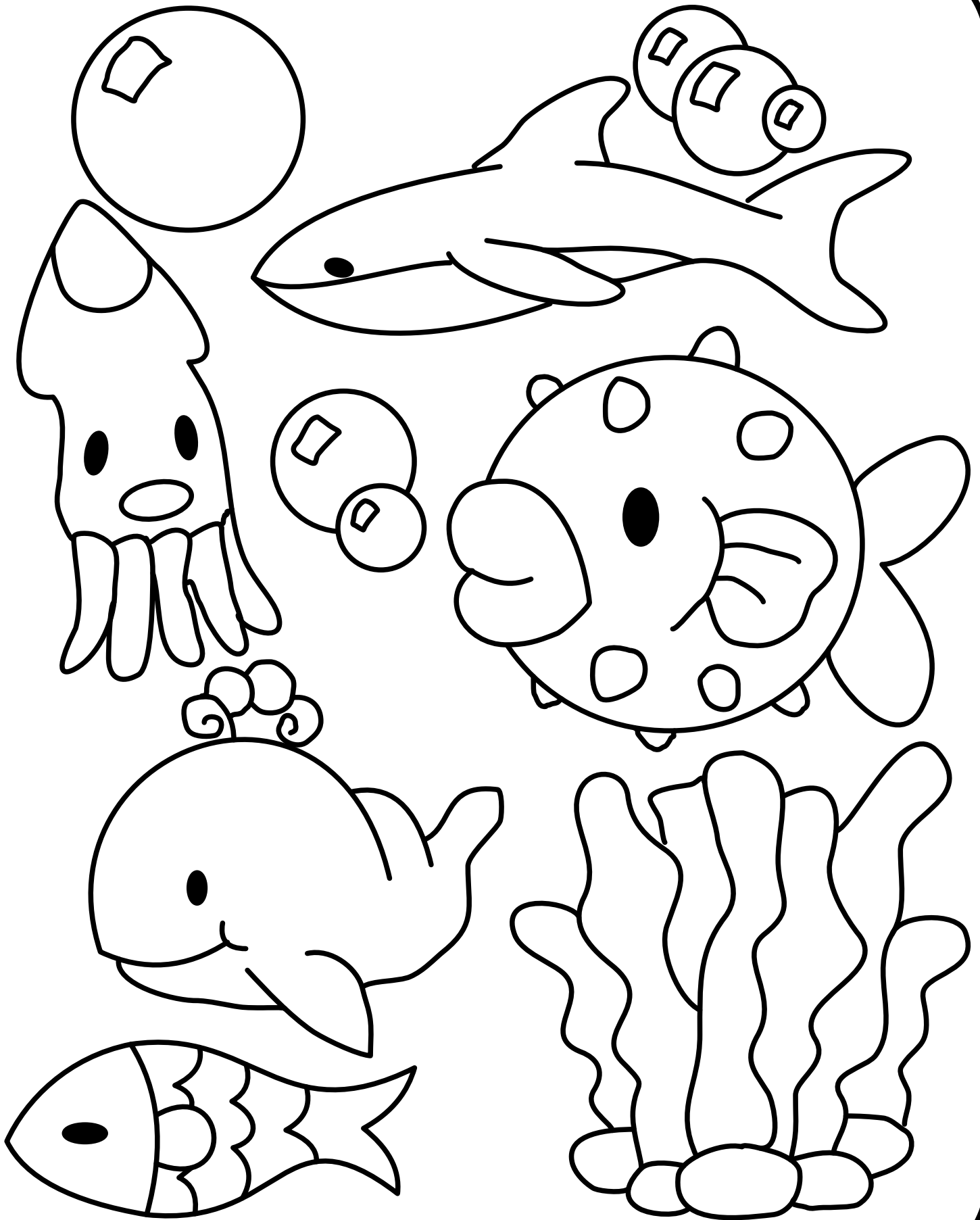
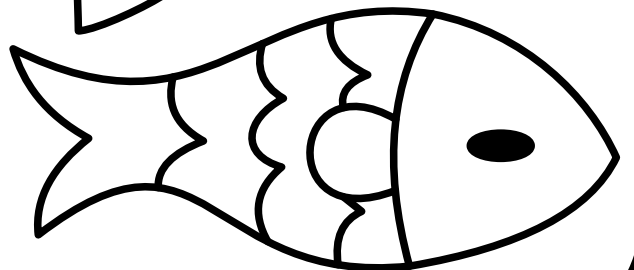
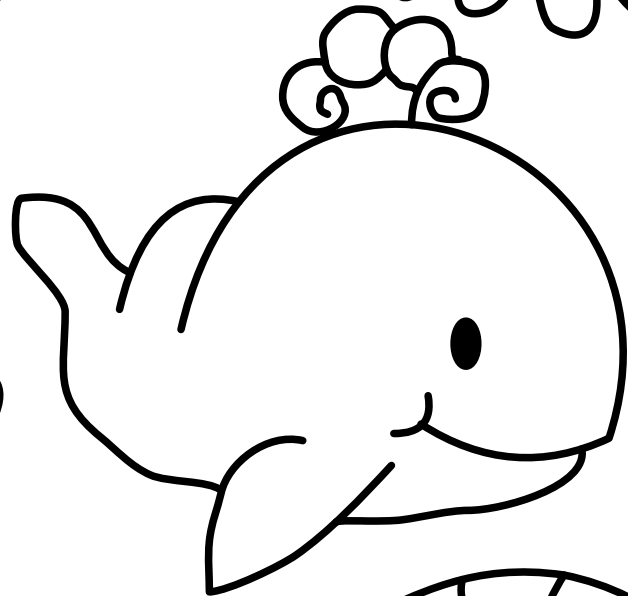
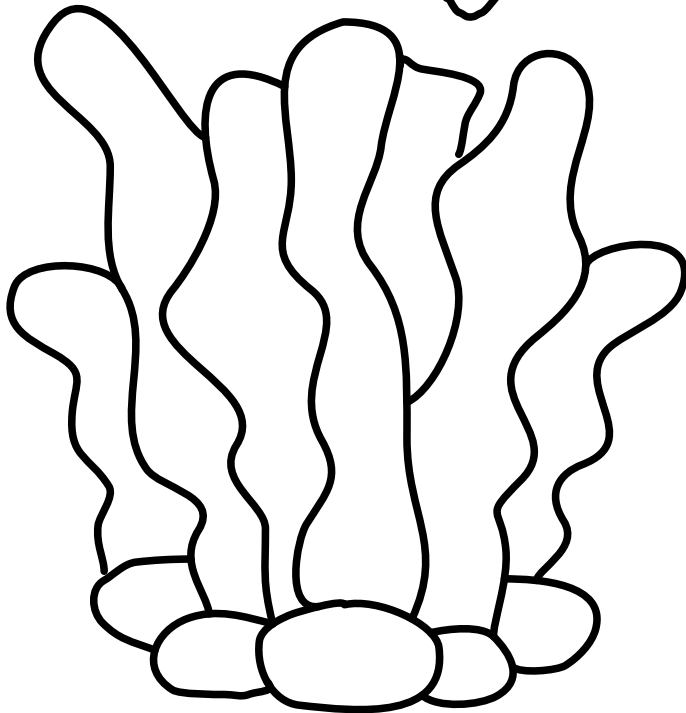
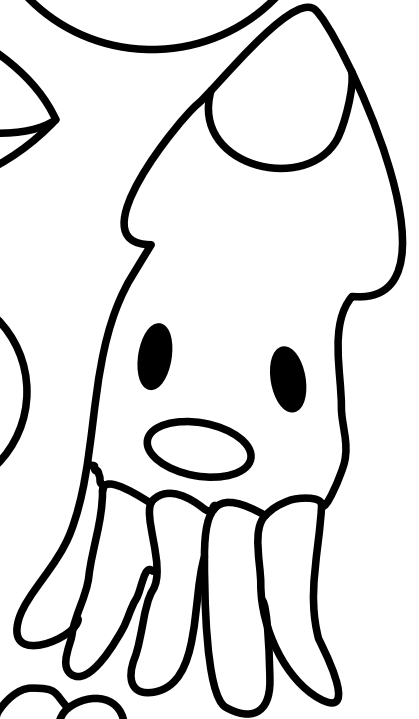
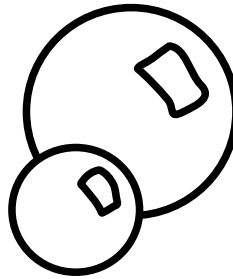
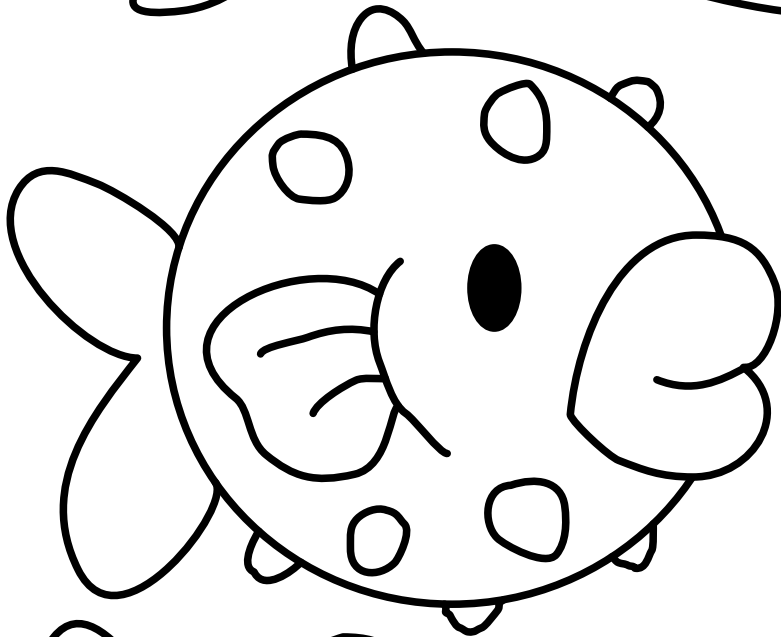
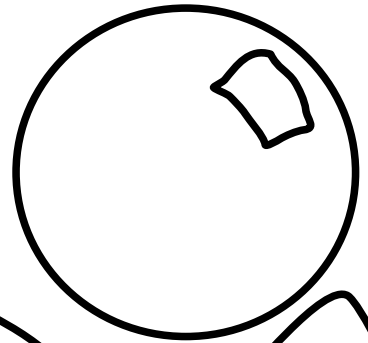
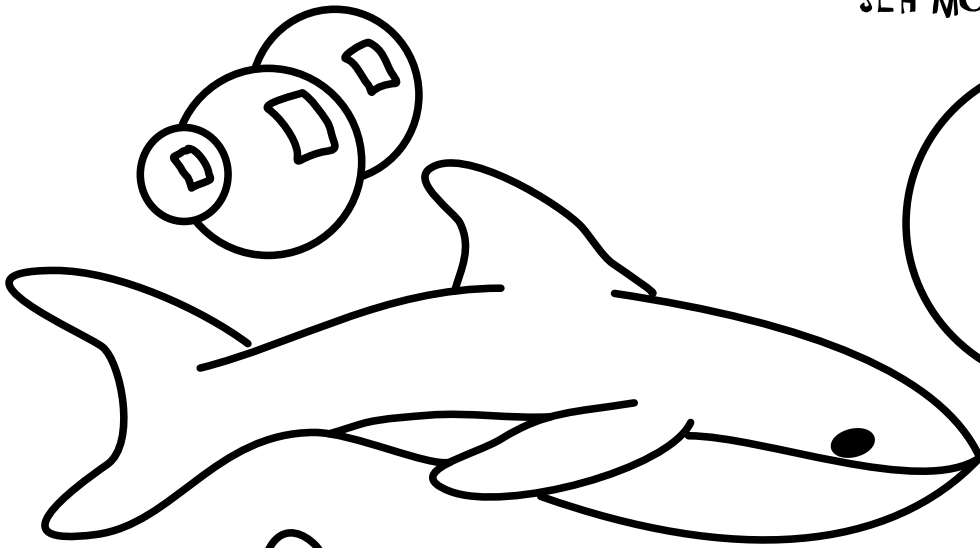

FIGURE 1





SNAKE MOBILE

MATERIALS

- pattern (p. 150)
- colors, markers, crayons
- cardboard (folder)
- scissors
- glue
- yarn
- hole punch



INSTRUCTIONS

1. Glue the pattern onto the cardboard. Color and cut out.
2. Punch a hole at the tip of the tail.
3. Thread a length of yarn through the hole, and hang.

3 SNAKE MOBILE PATTERN

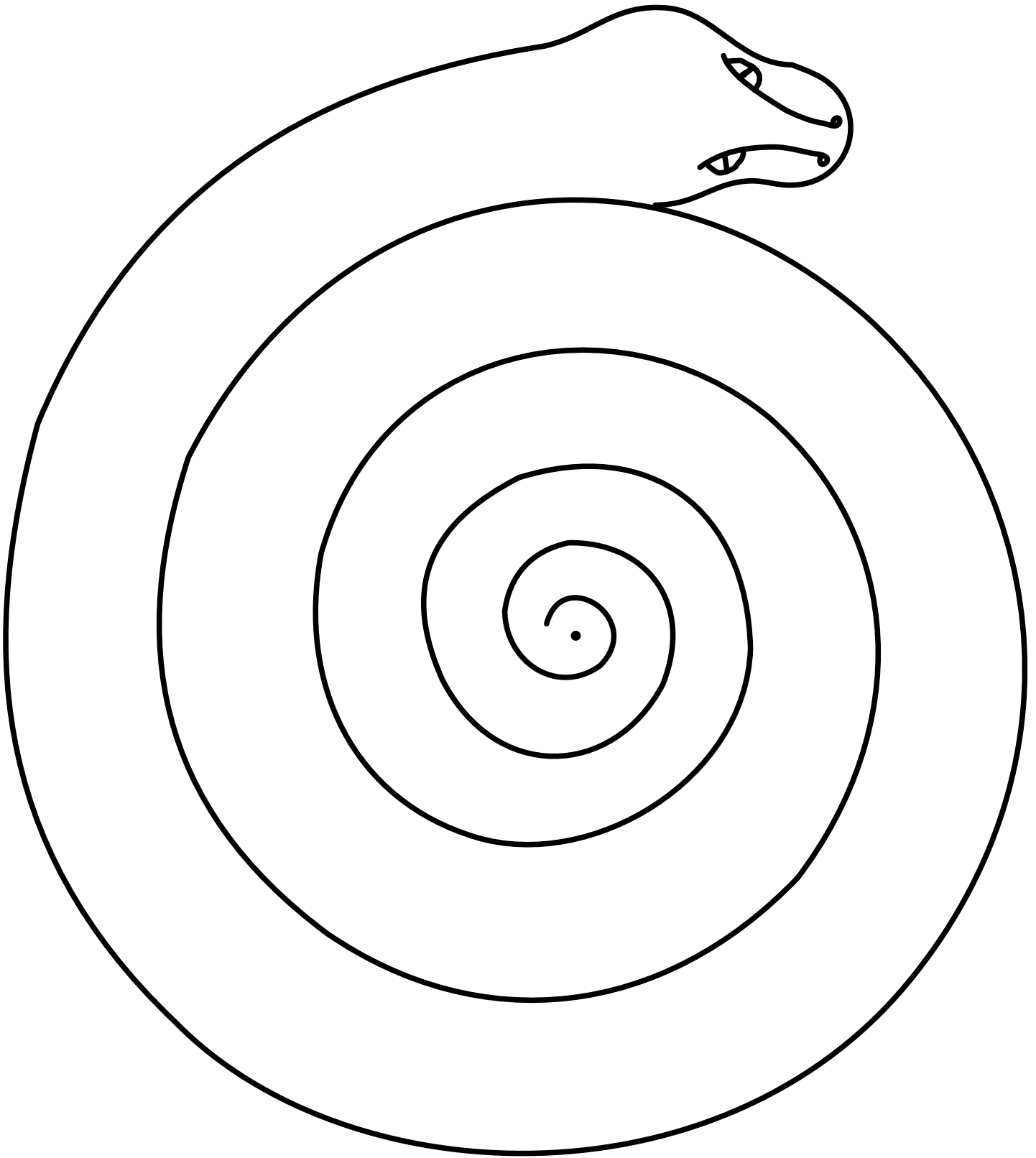

PAPER TUBE

MATERIALS

- patterns (pp. 154 - 191)
- toilet paper tube
- colors, crayons, markers
- glue or tape
- cardboard (folder, cereal box)
- scissors

GENERAL INSTRUCTIONS

1. Color and decorate the patterns you chose.
2. Glue them onto the cardboard and cut out.
3. Color the paper tube and glue the patterns on to look like given example.

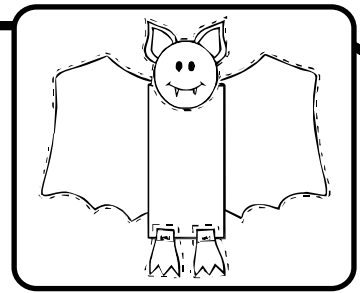

BAT

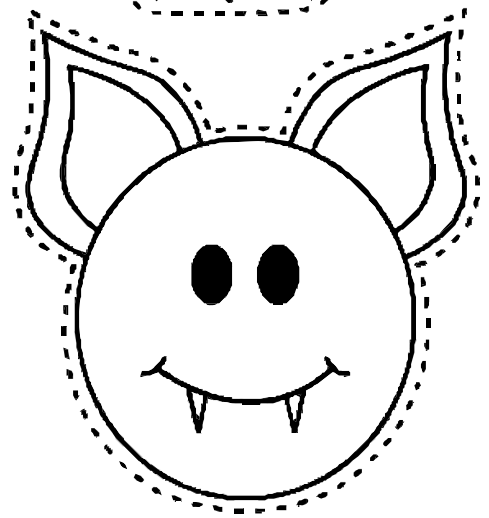
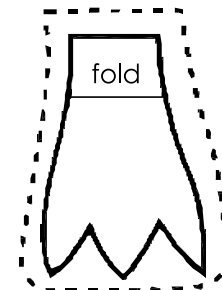
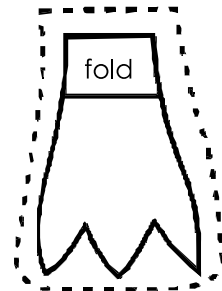
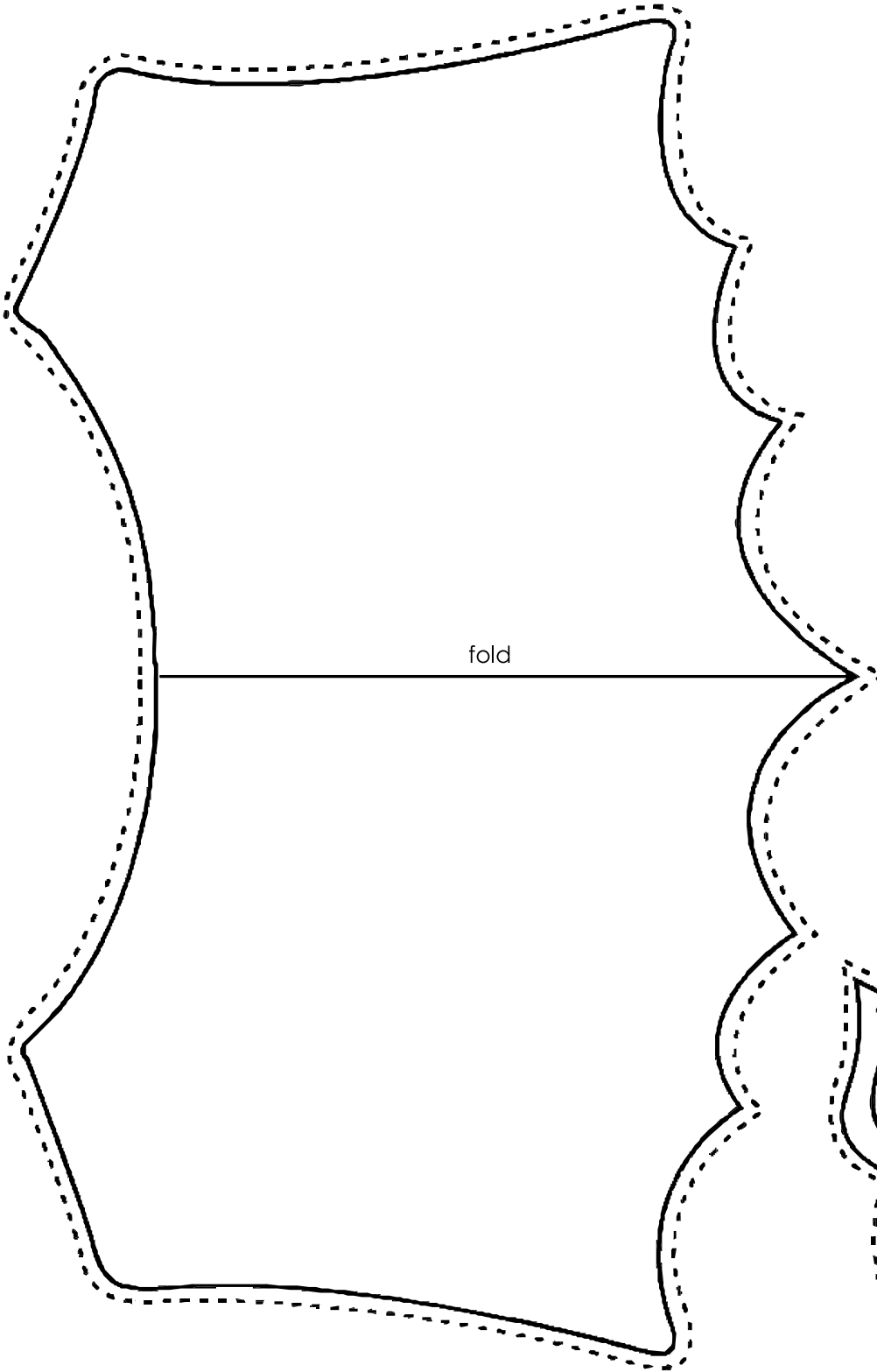

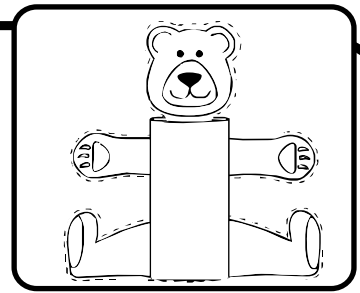

BEAR

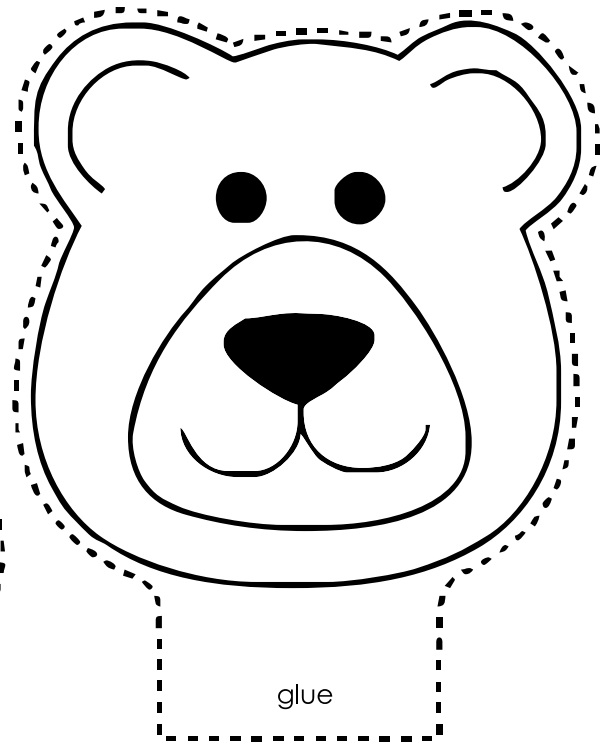
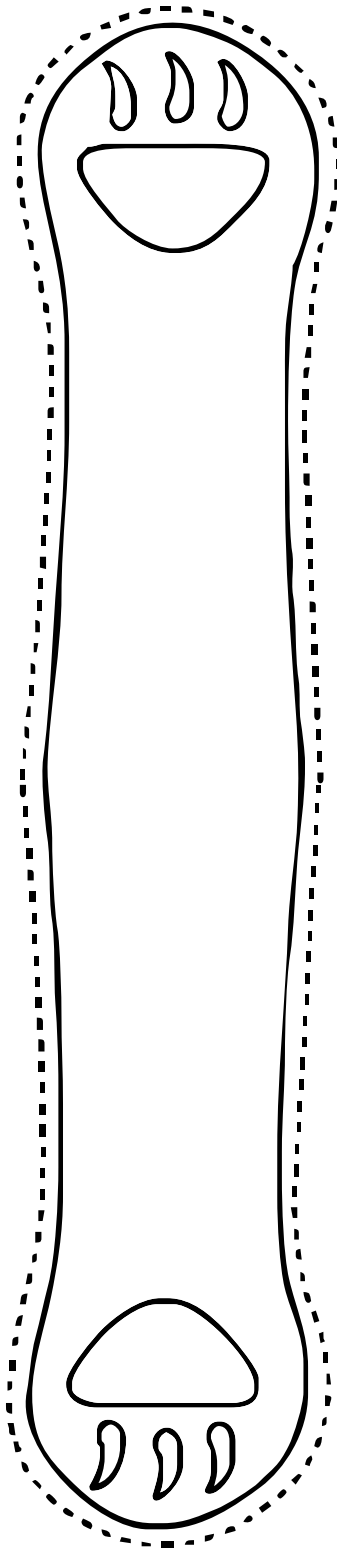
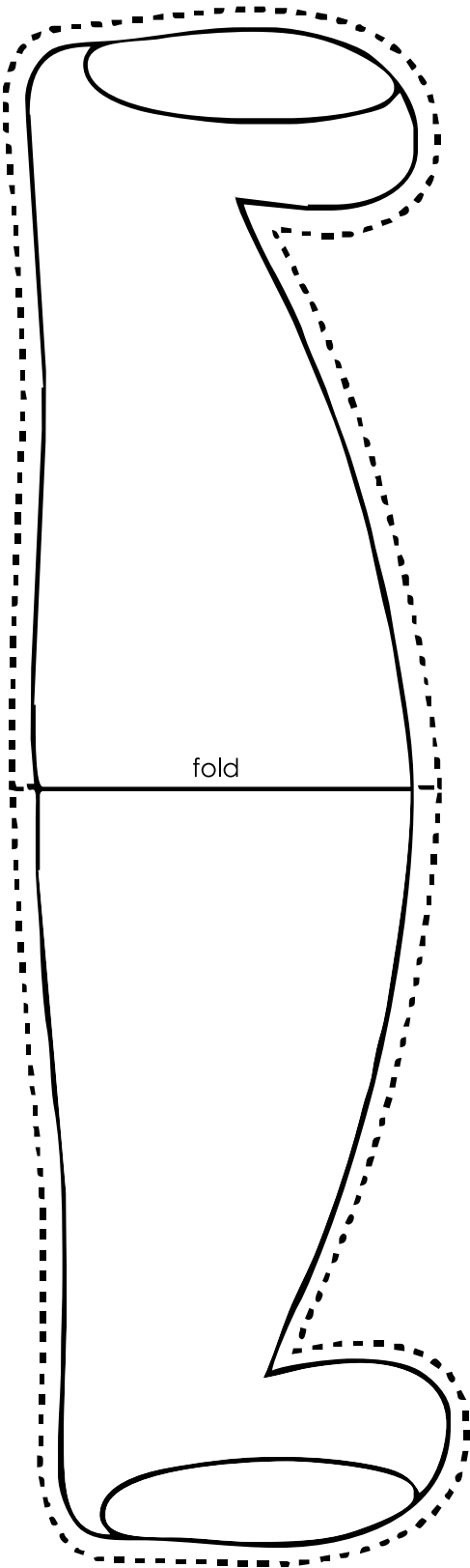

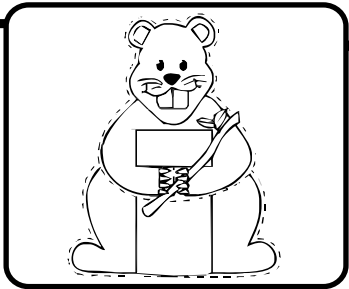

BEAVER

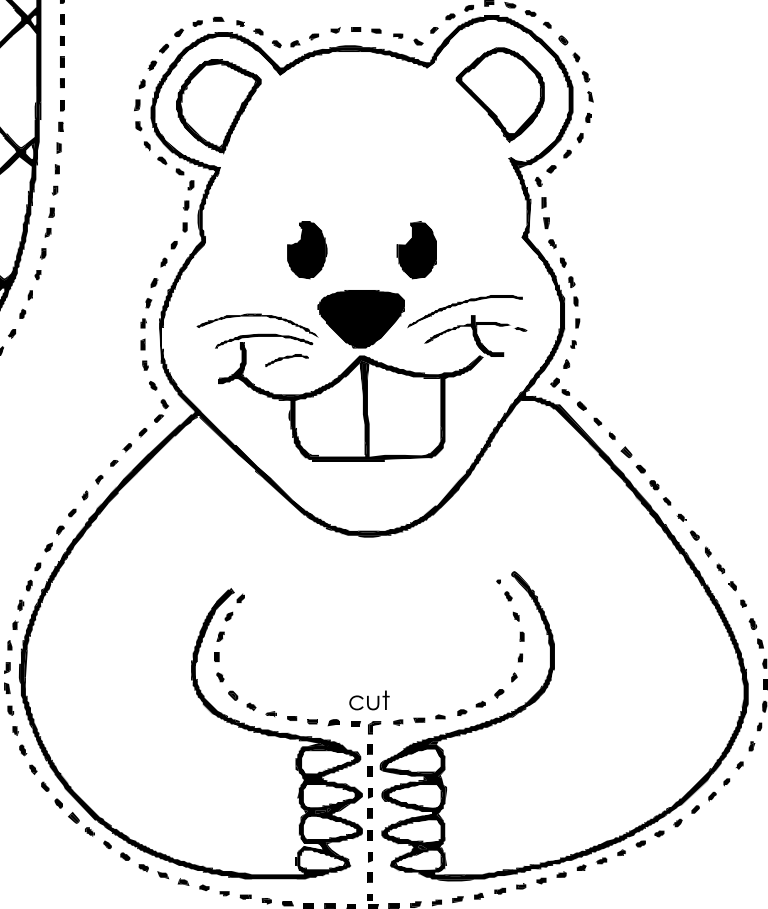
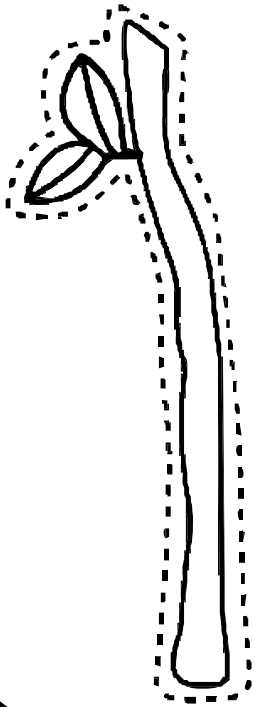
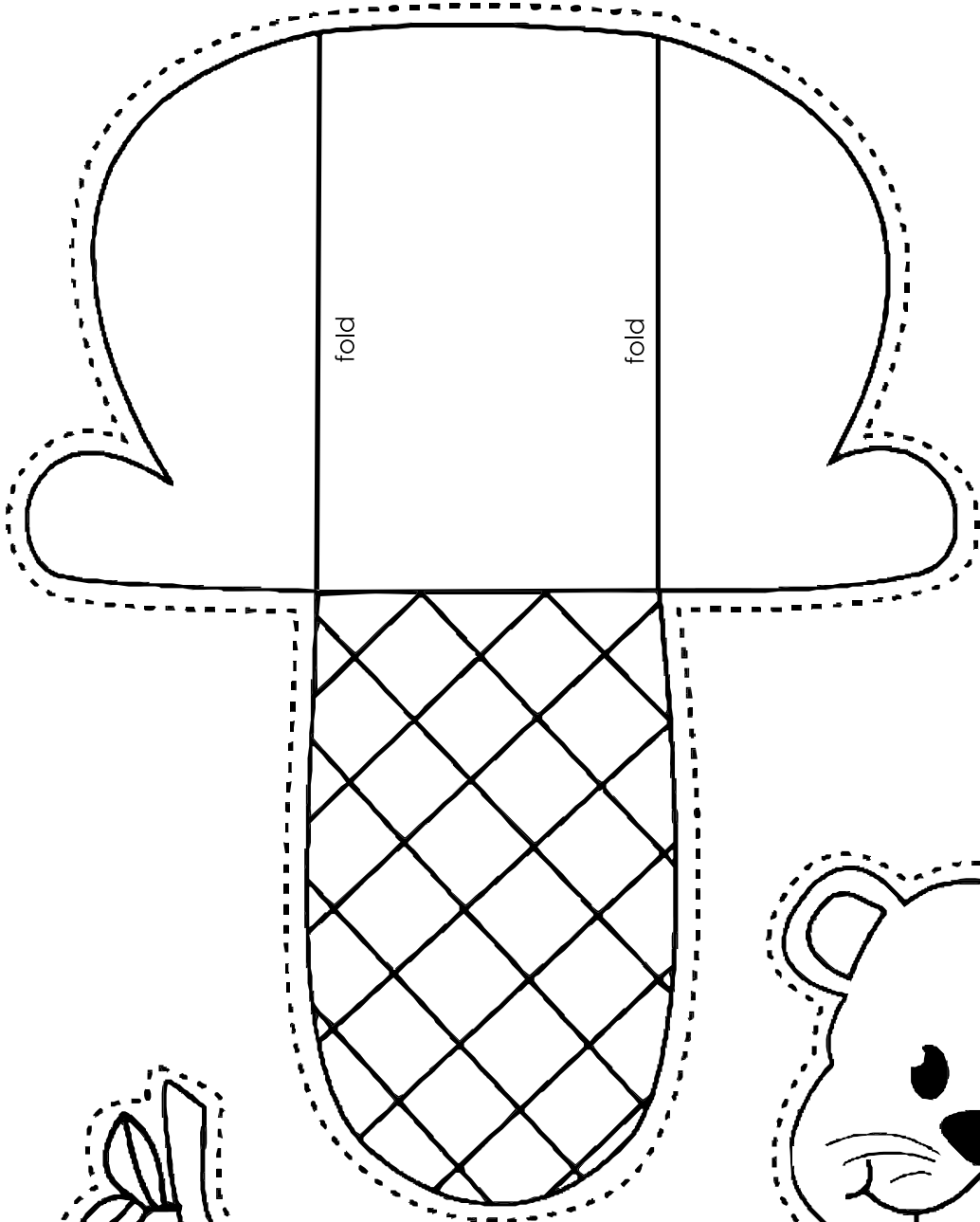

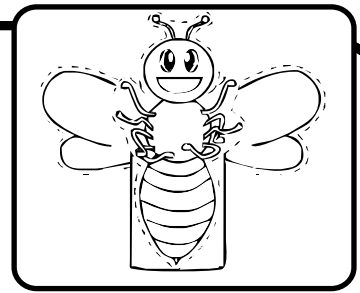

BEE

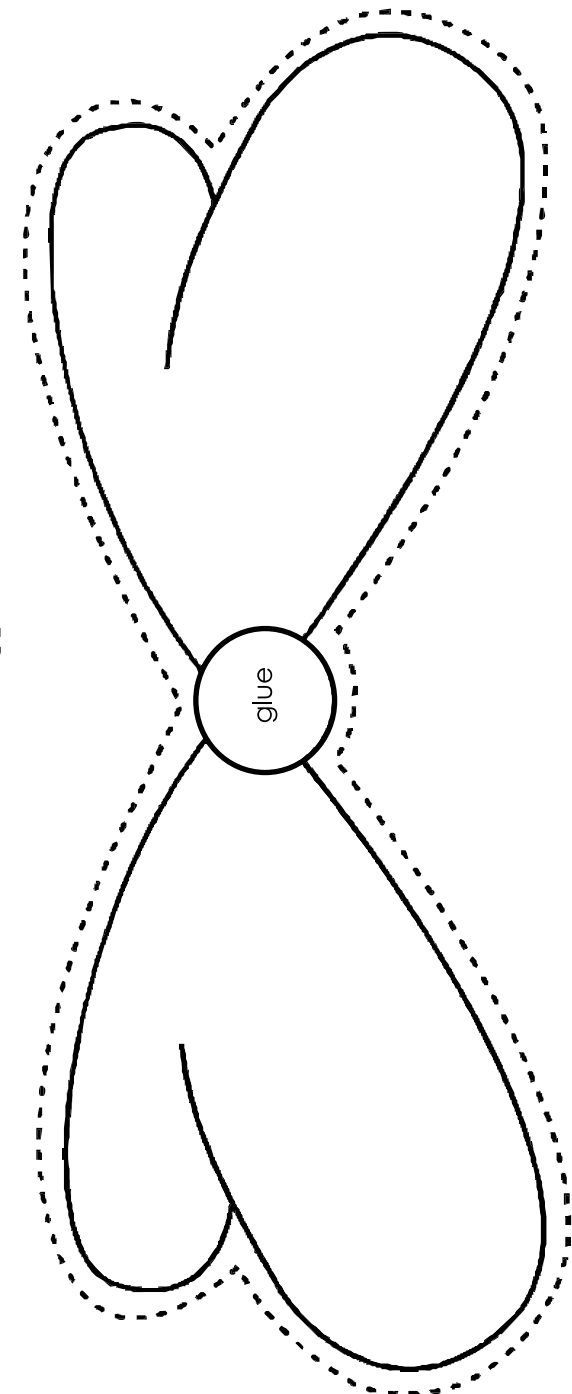
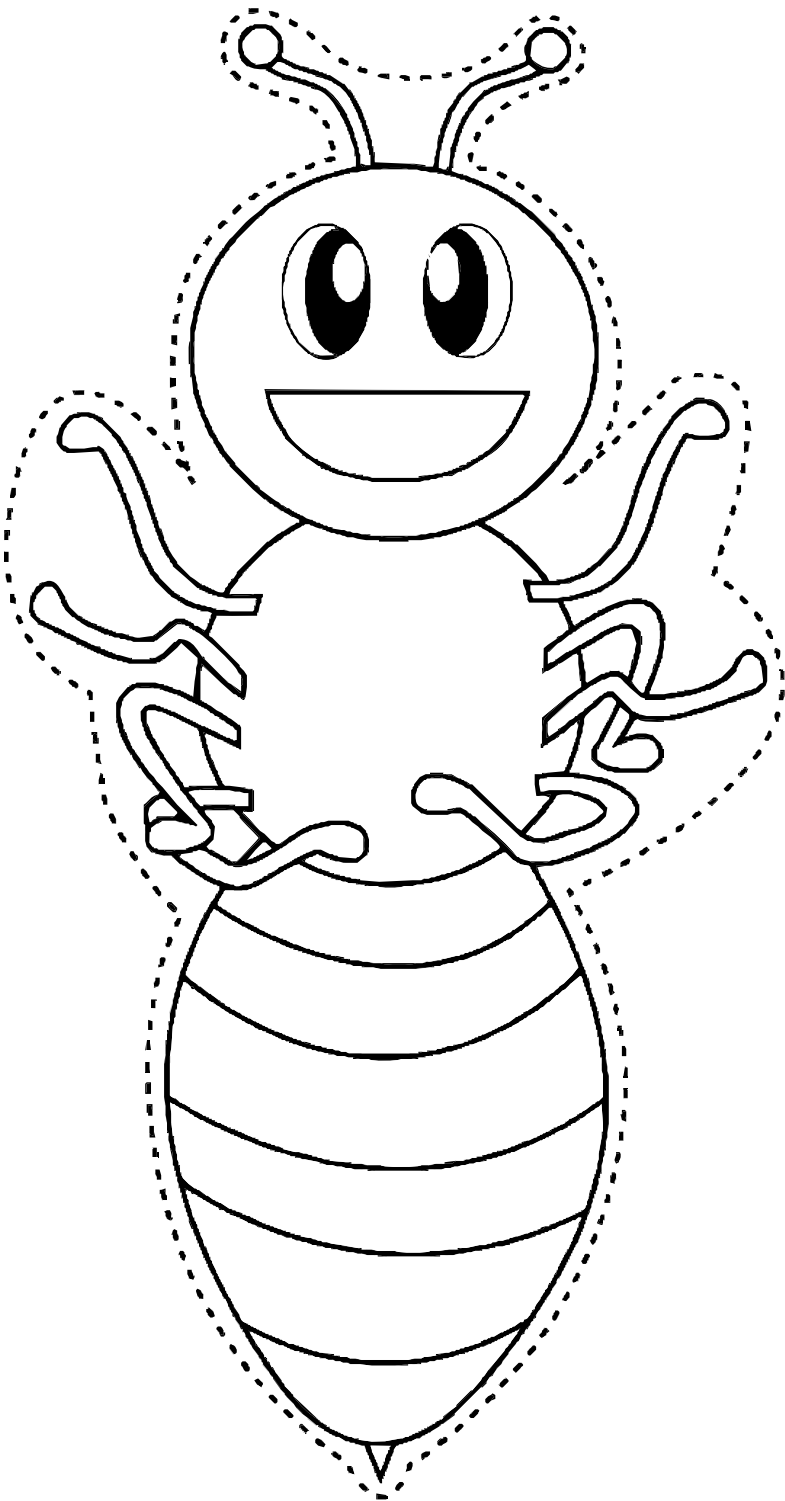

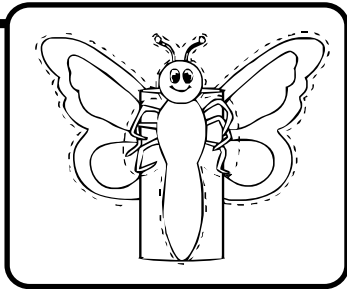

BUTTERFLY

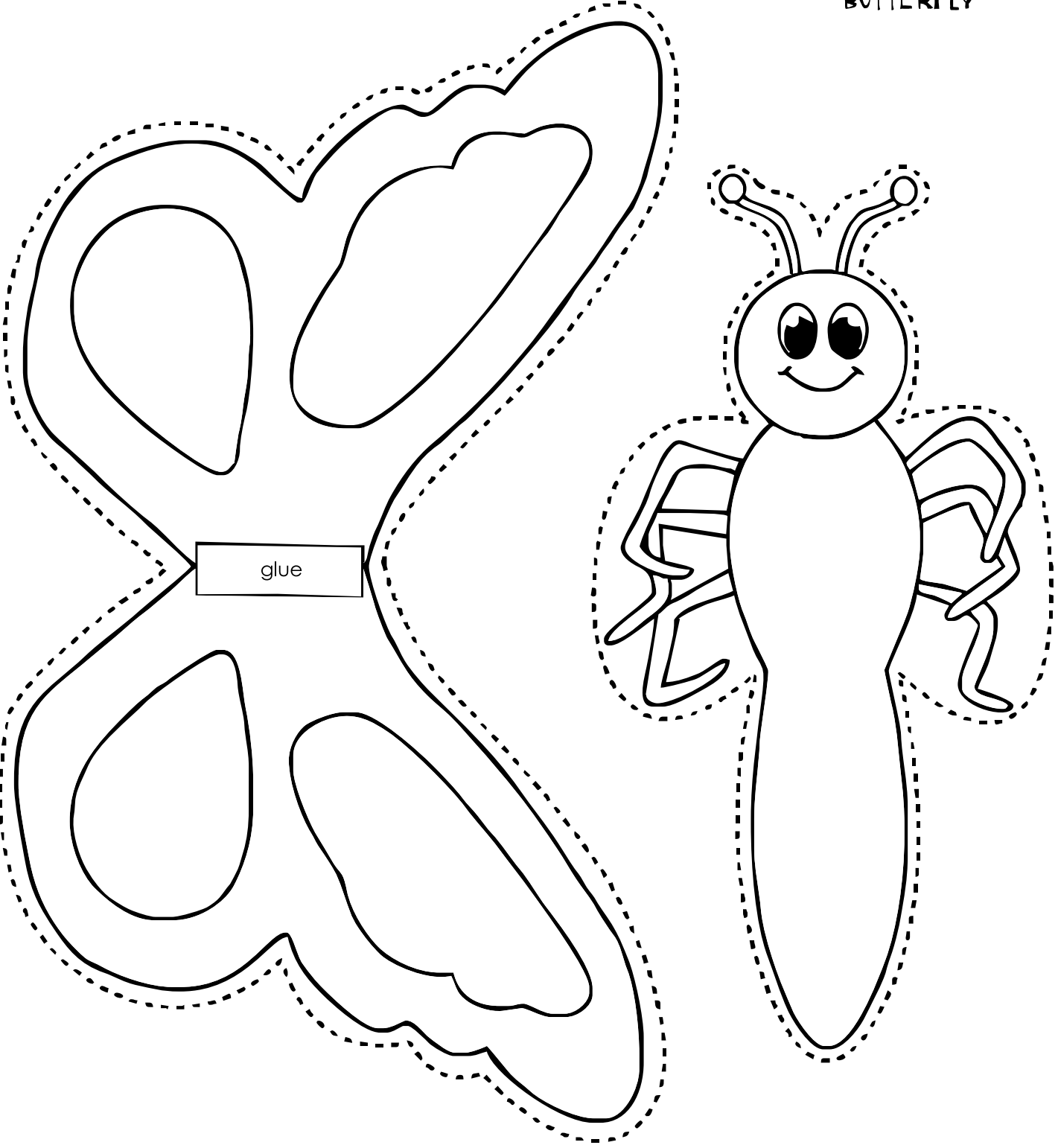

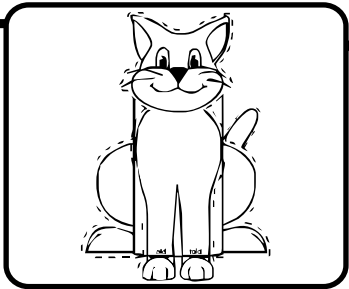

CAT

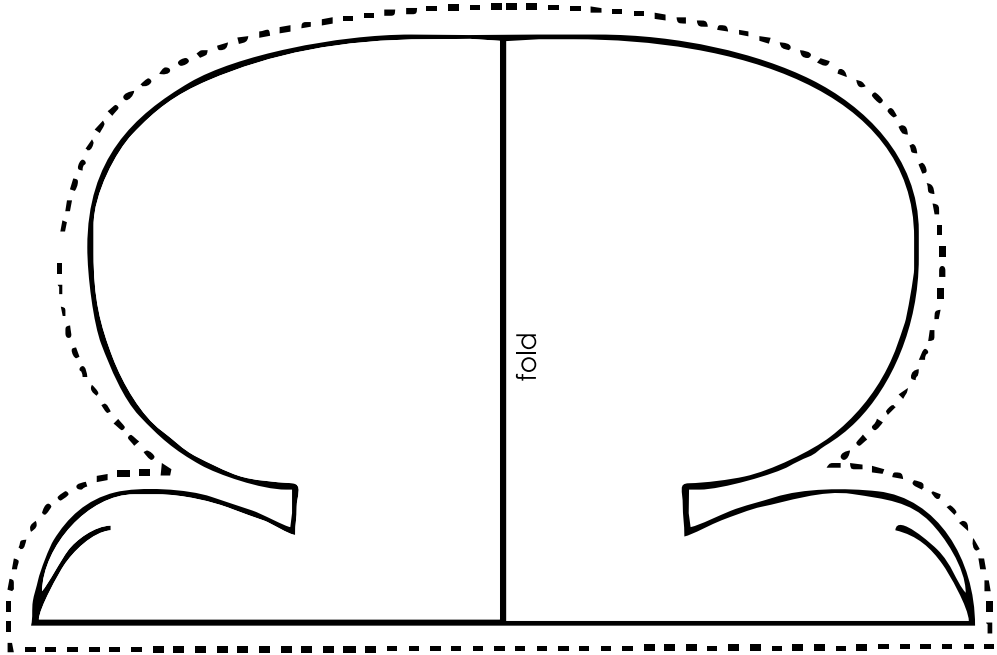
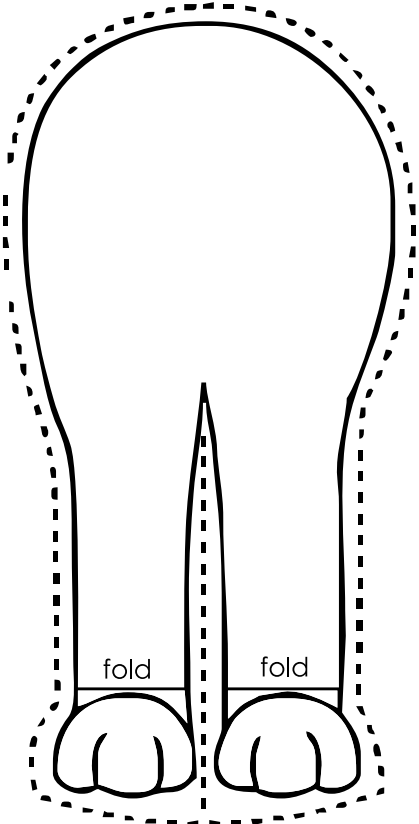
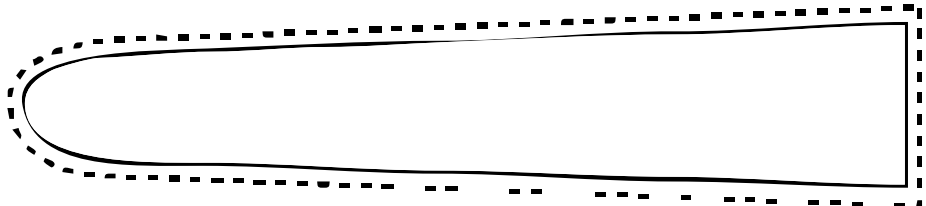
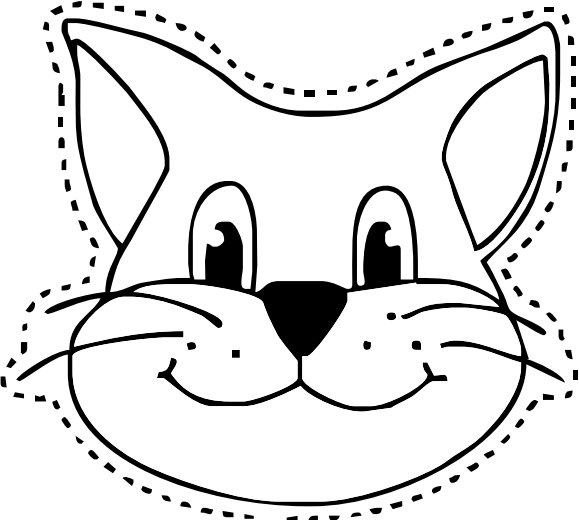

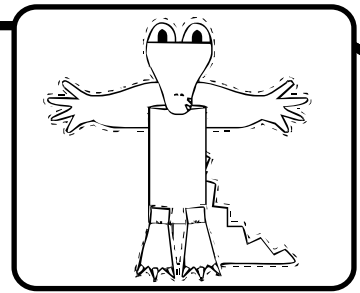

CROCODILE

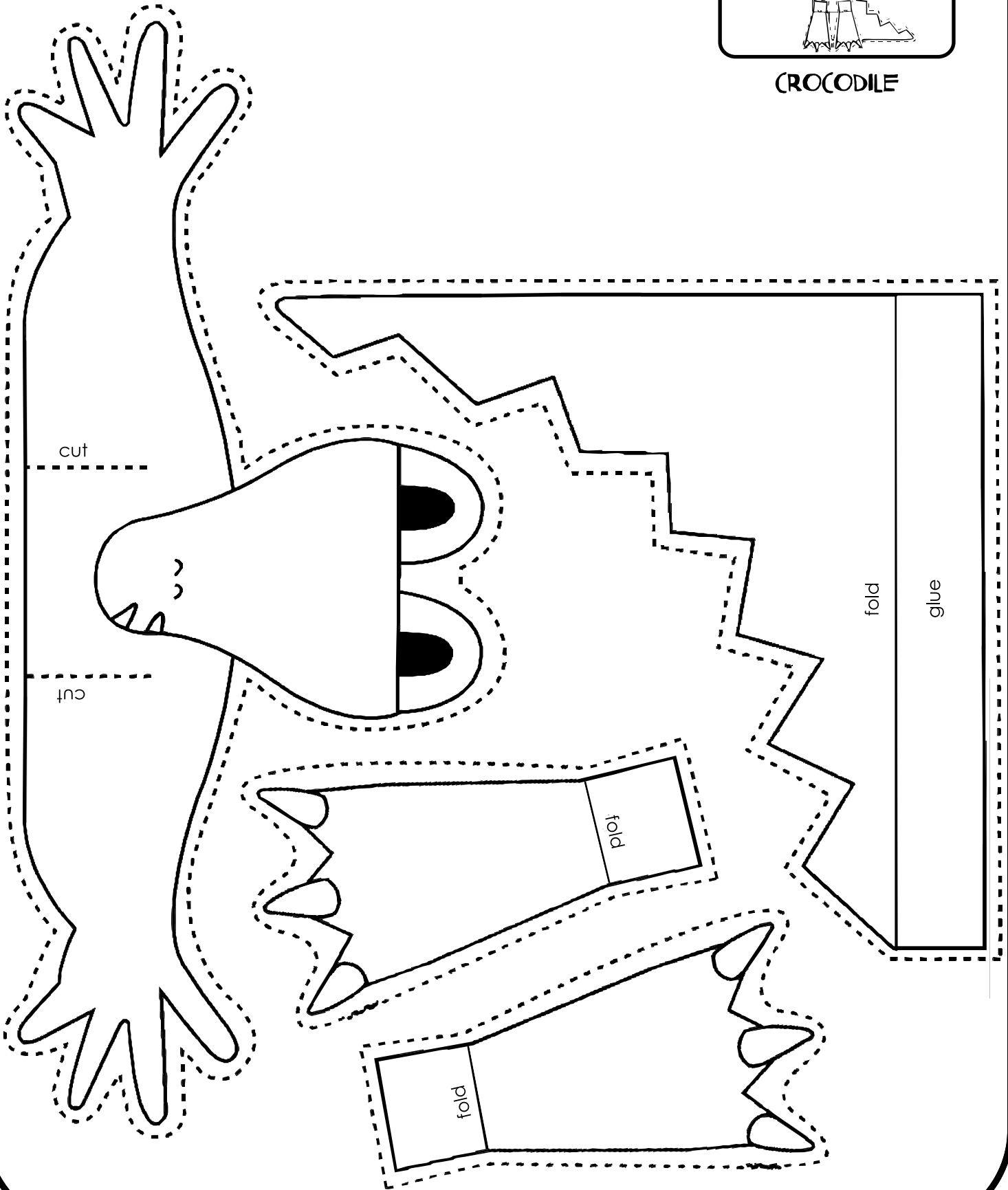

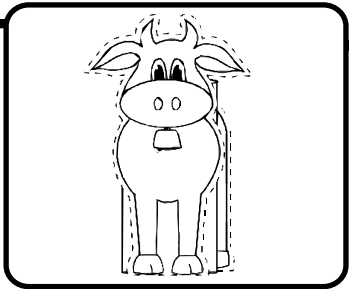

COW

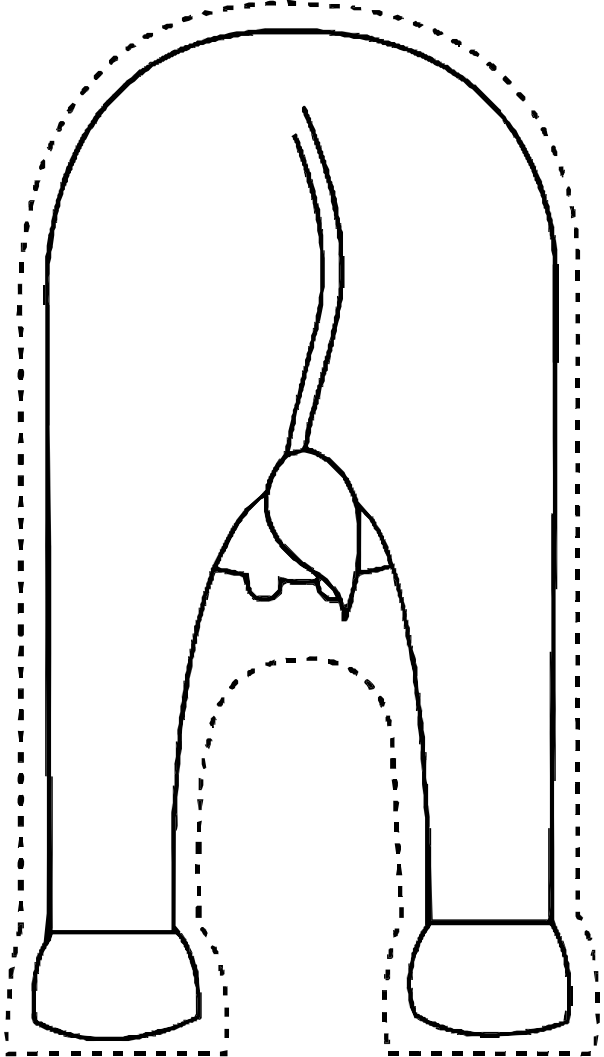
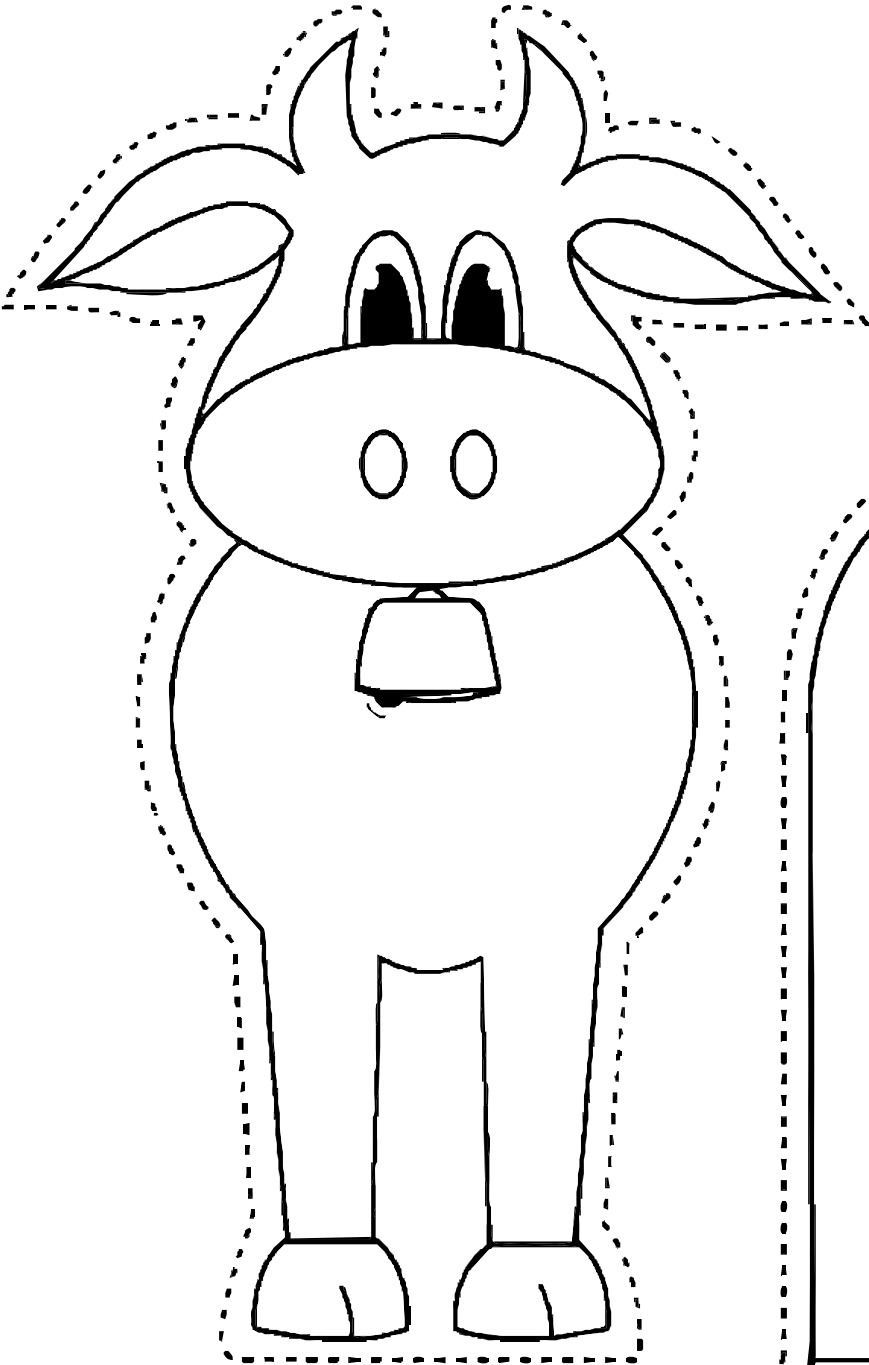

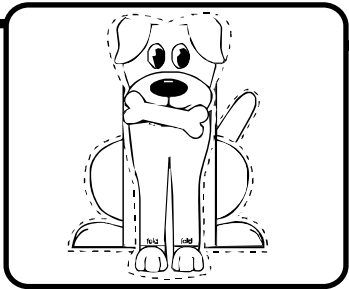

DOG

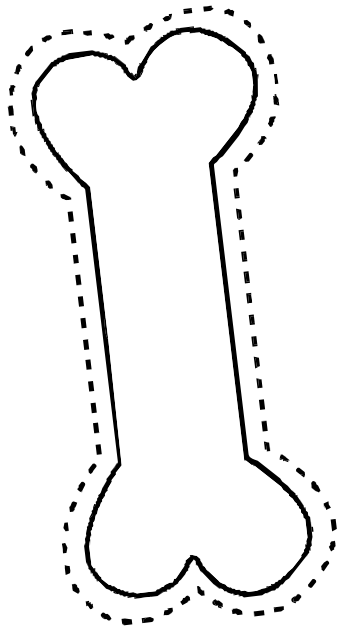
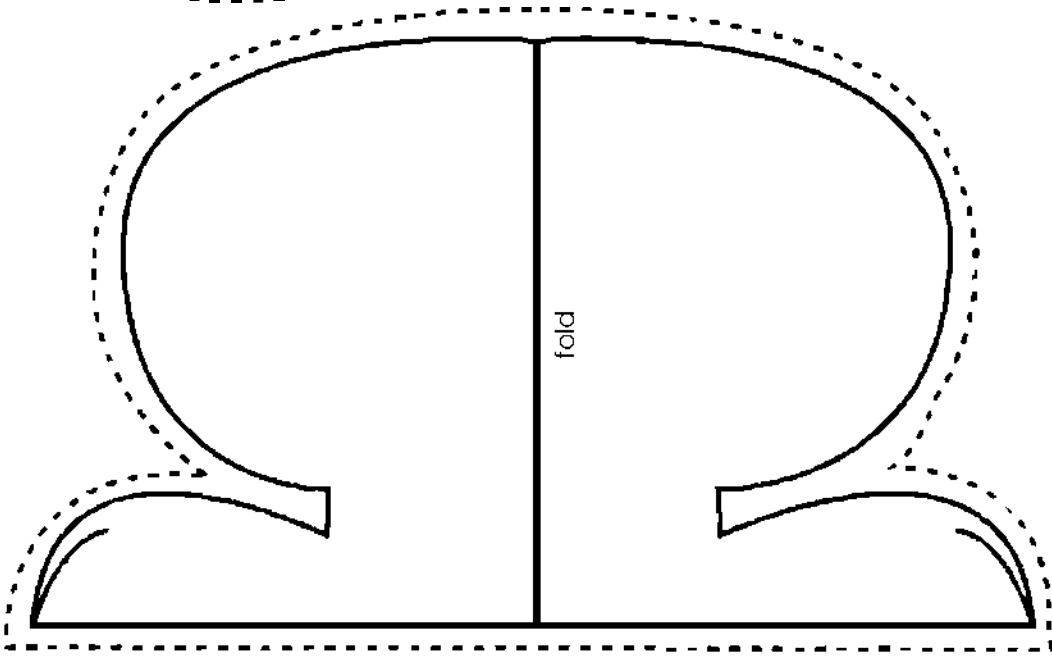
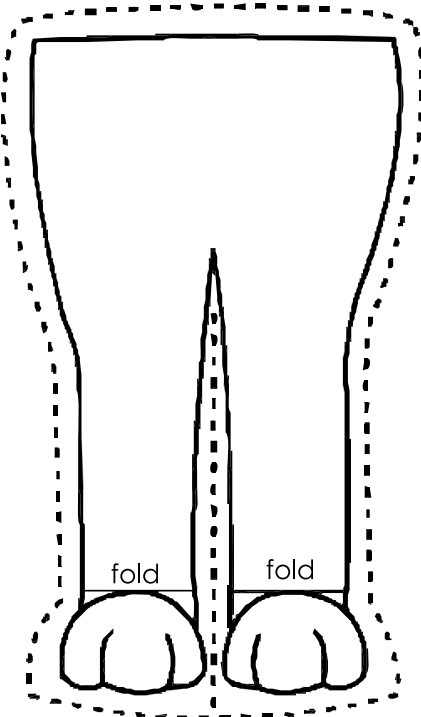
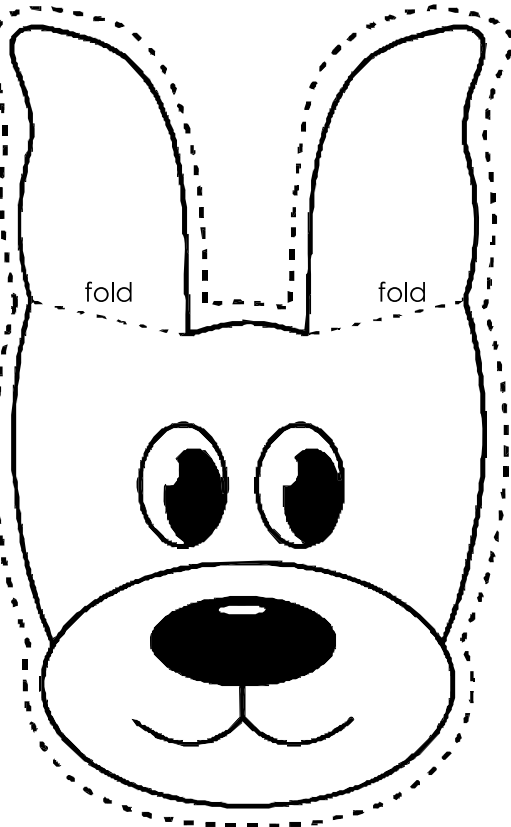

PAPER TUBE

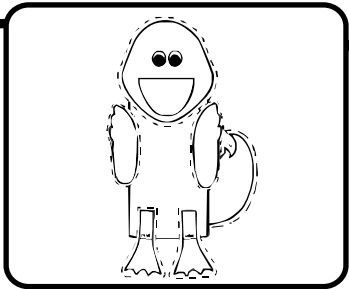

DUCK

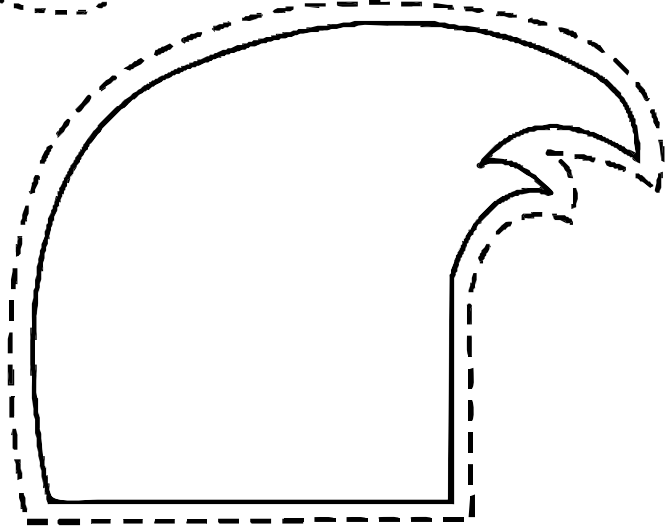
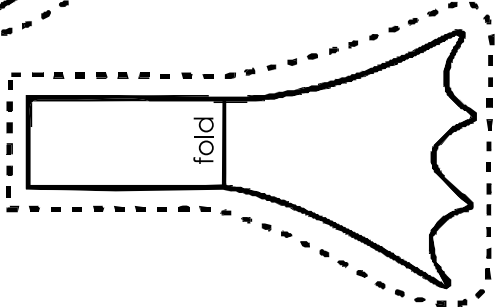
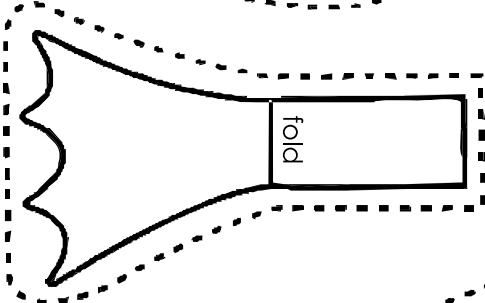
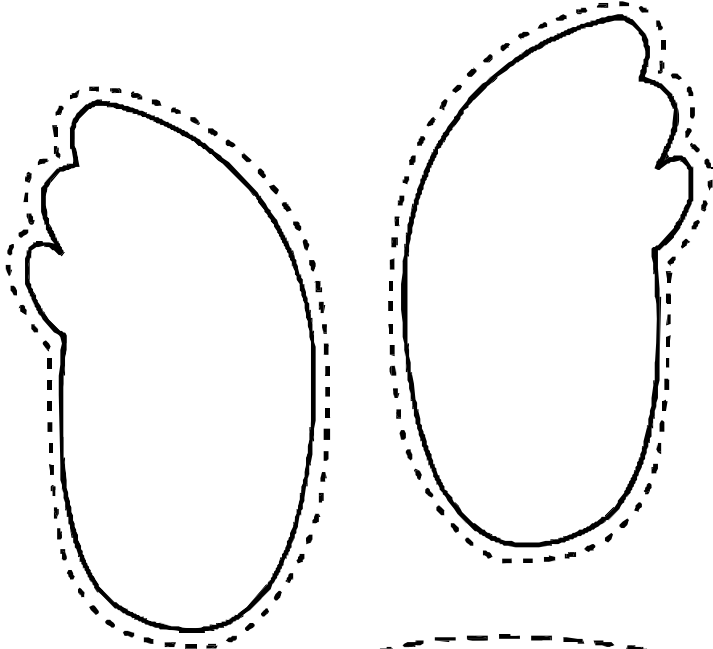
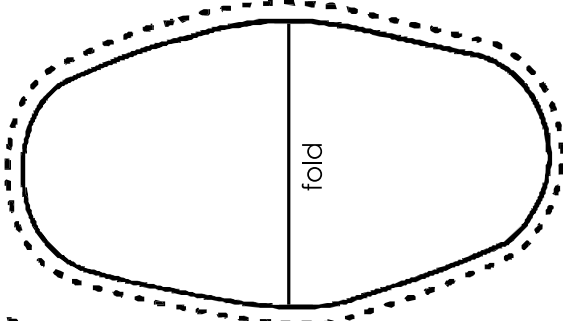
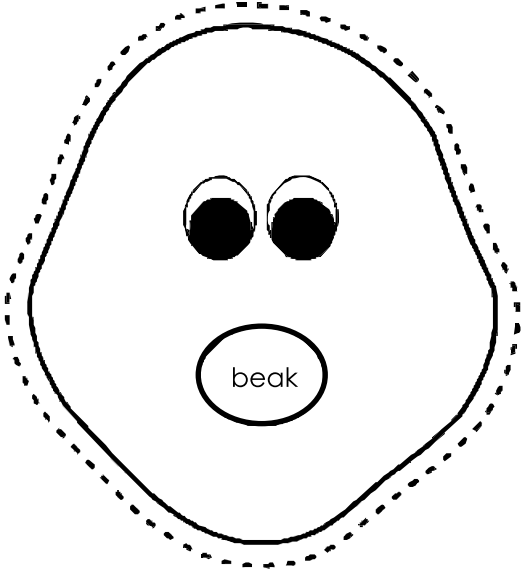

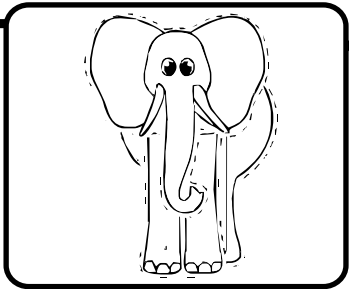

ELEPHANT

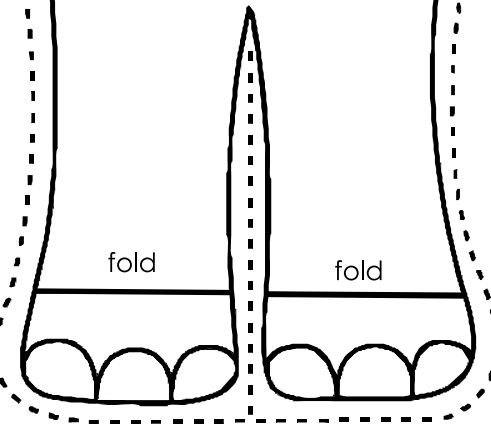
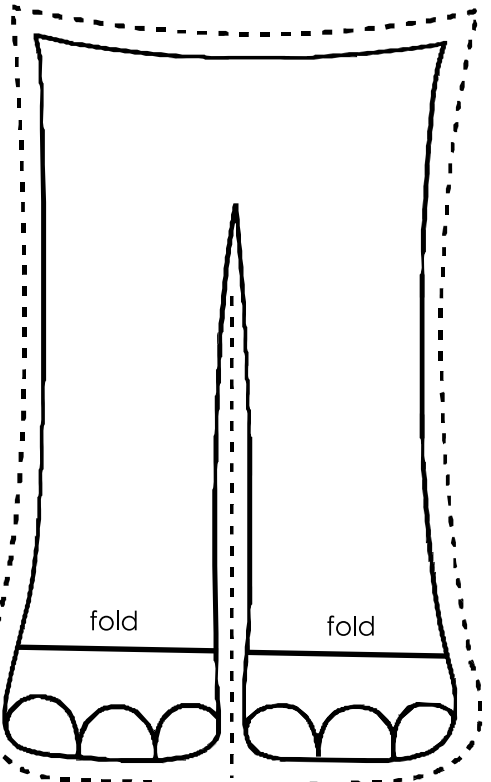
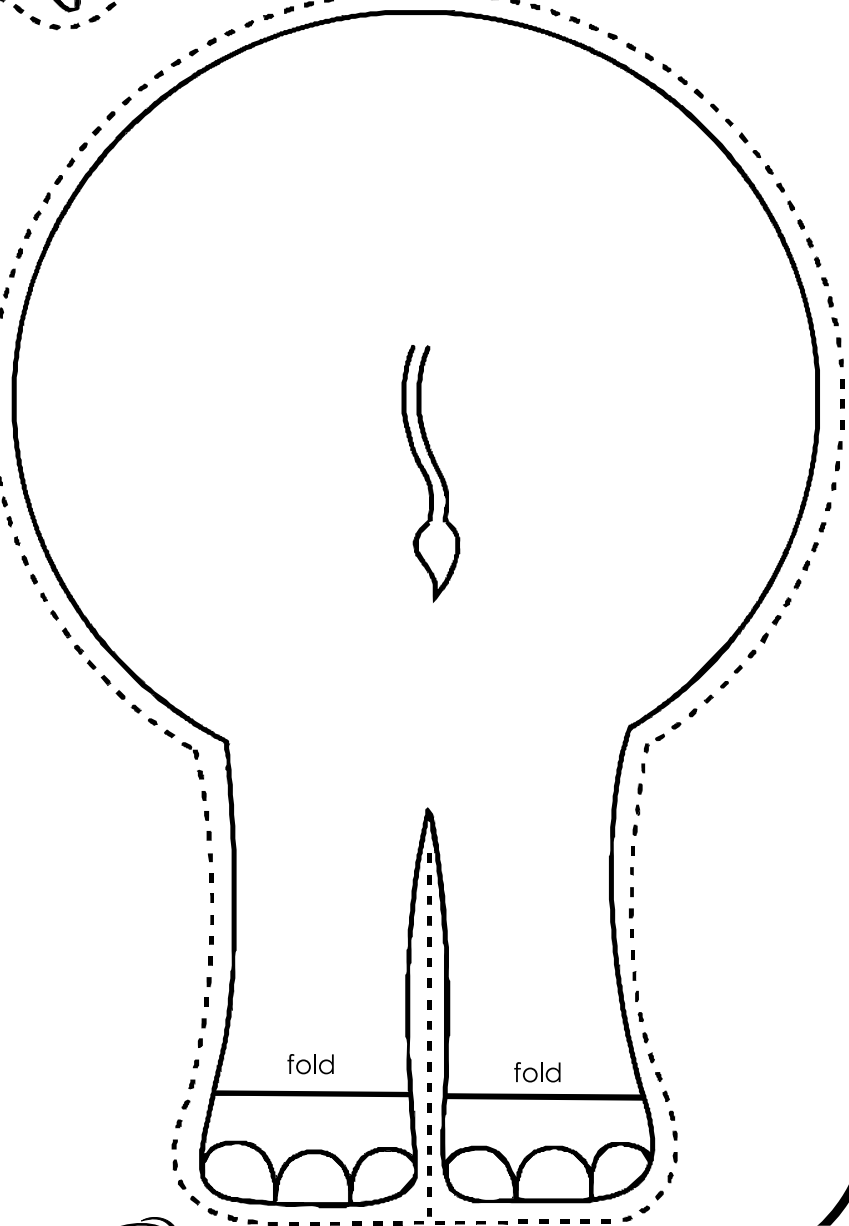
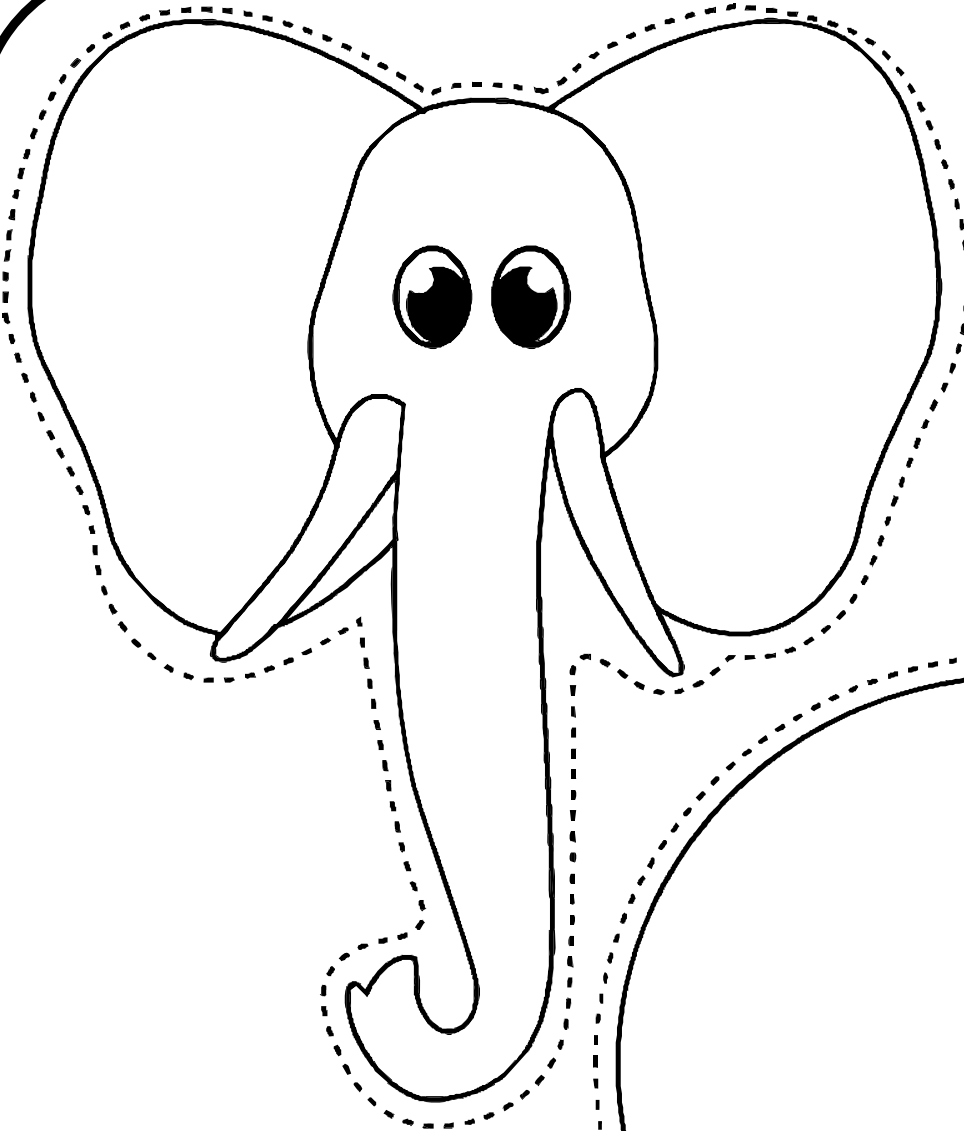

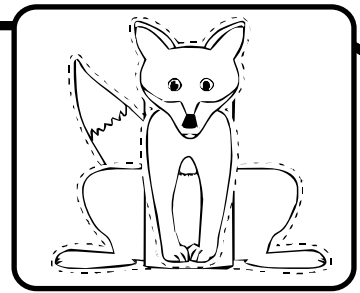

FOX

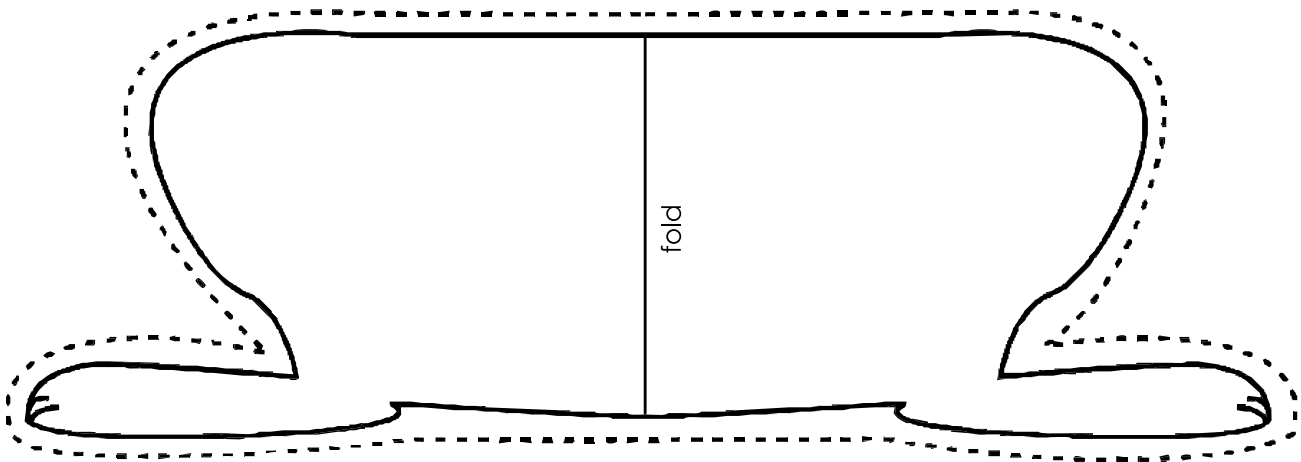
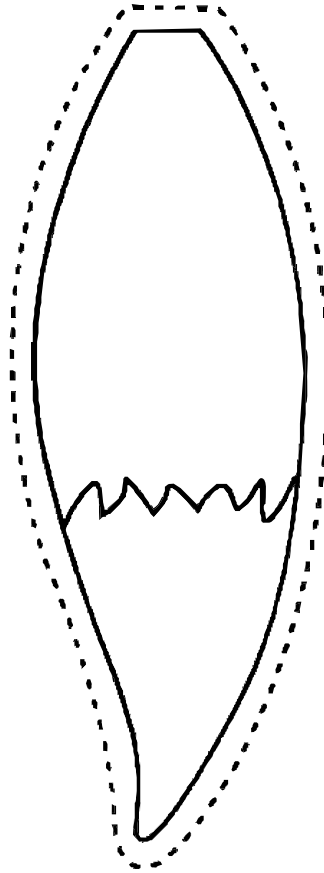
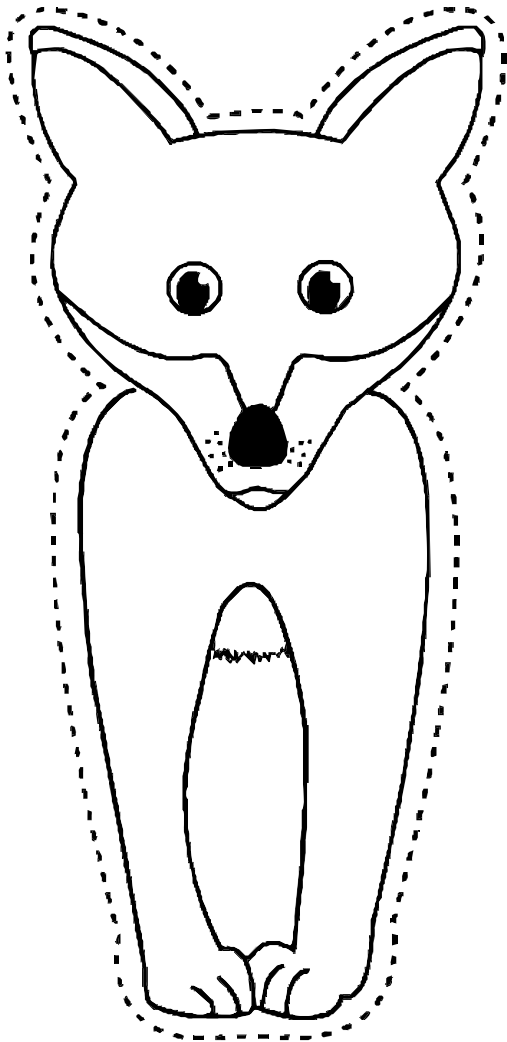

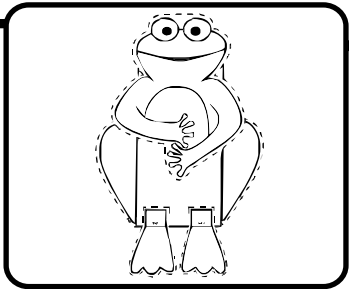

FROG

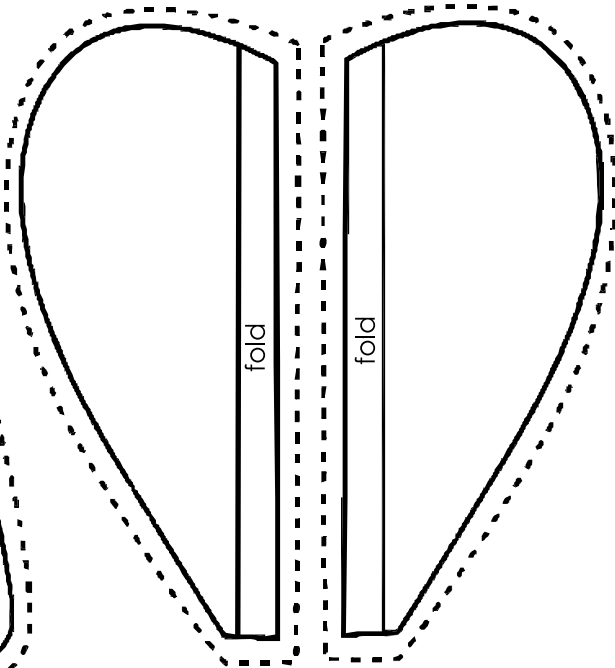
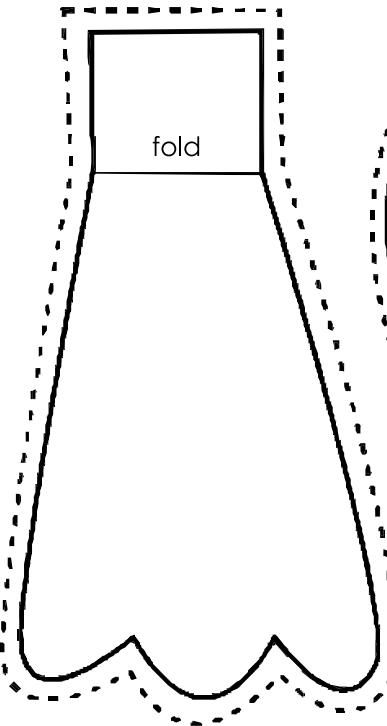
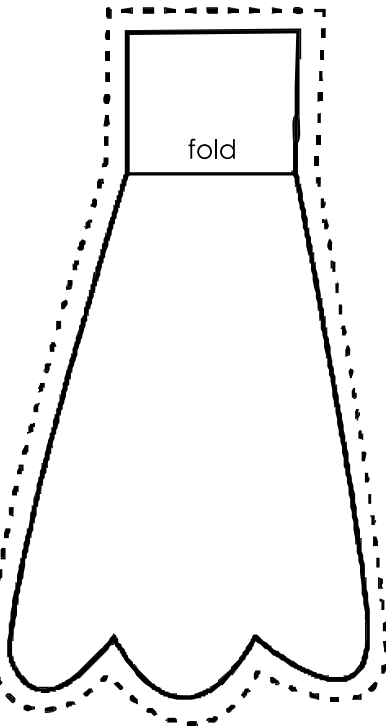
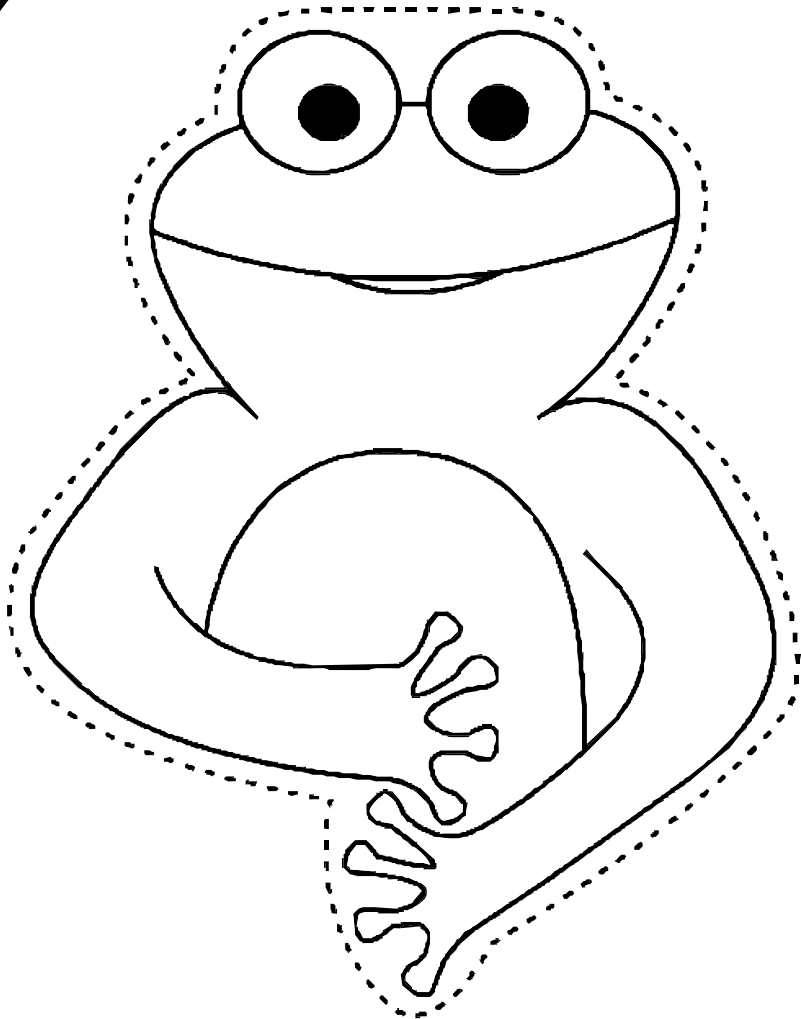

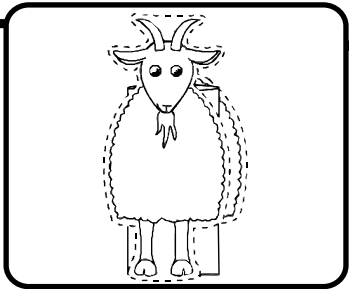

GOAT

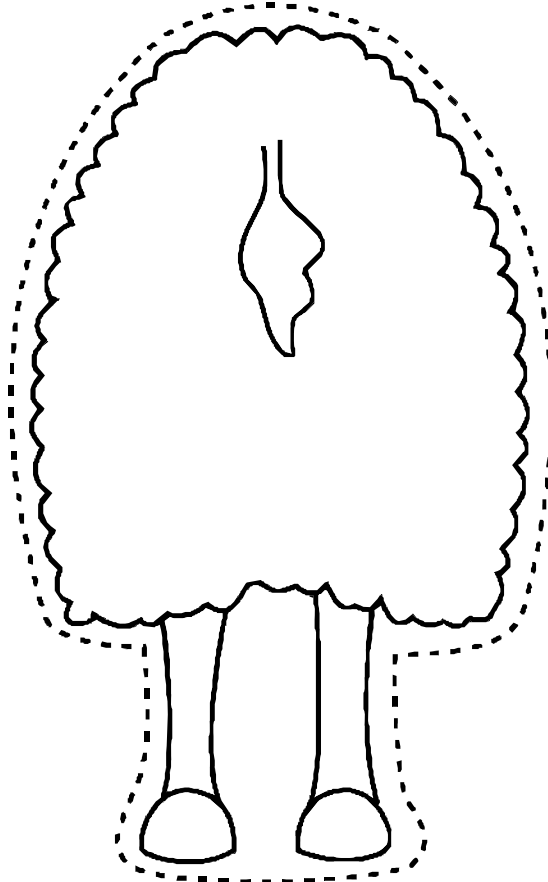
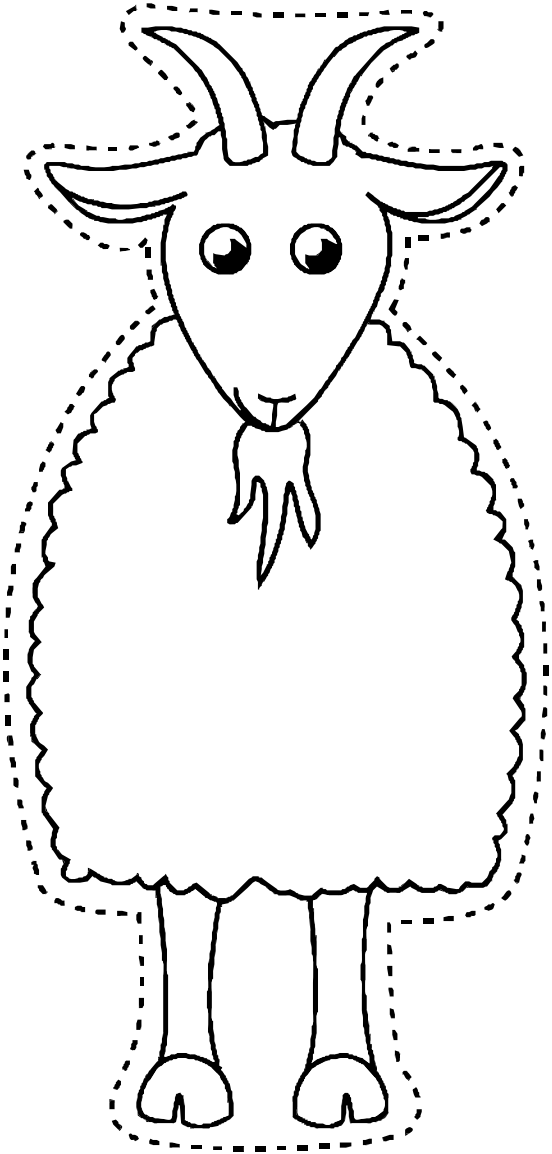



HEN

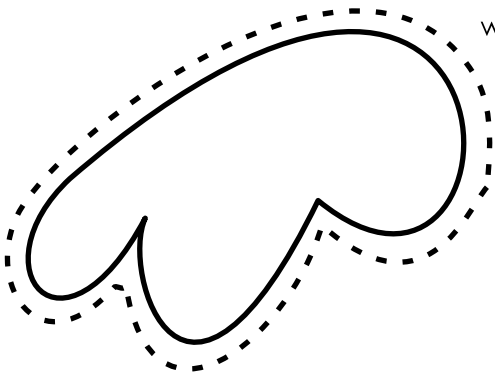
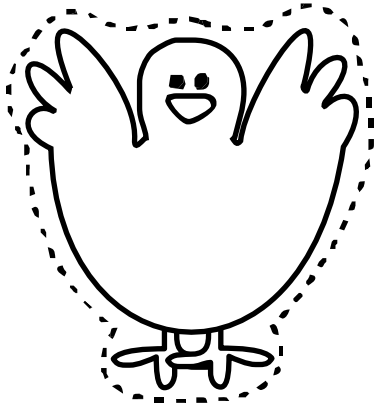
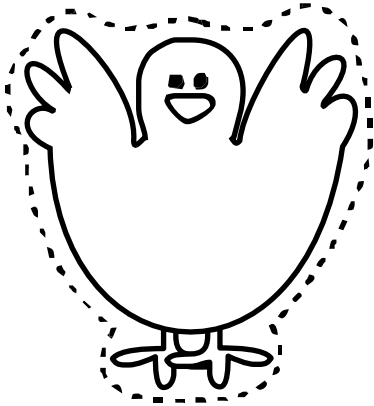
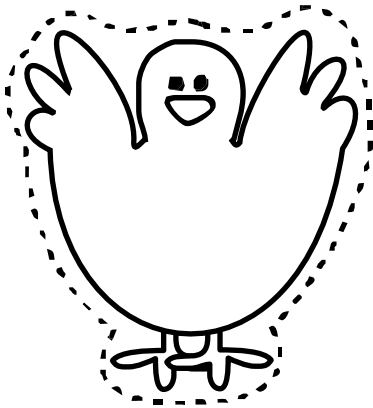
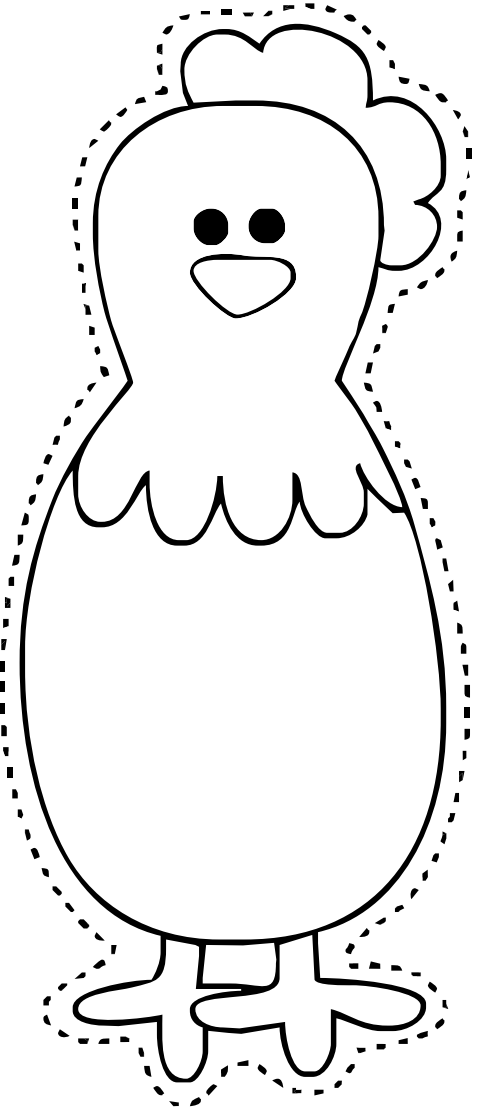

wings

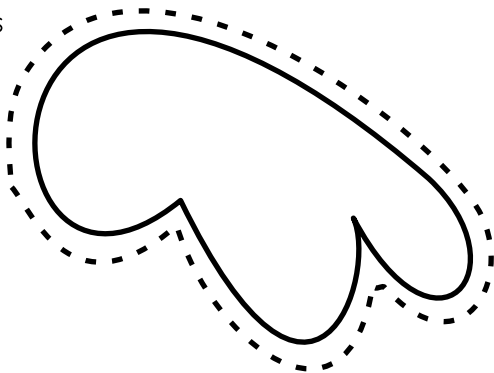

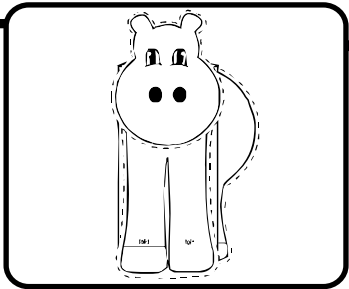

HIPPOPOTAMUS

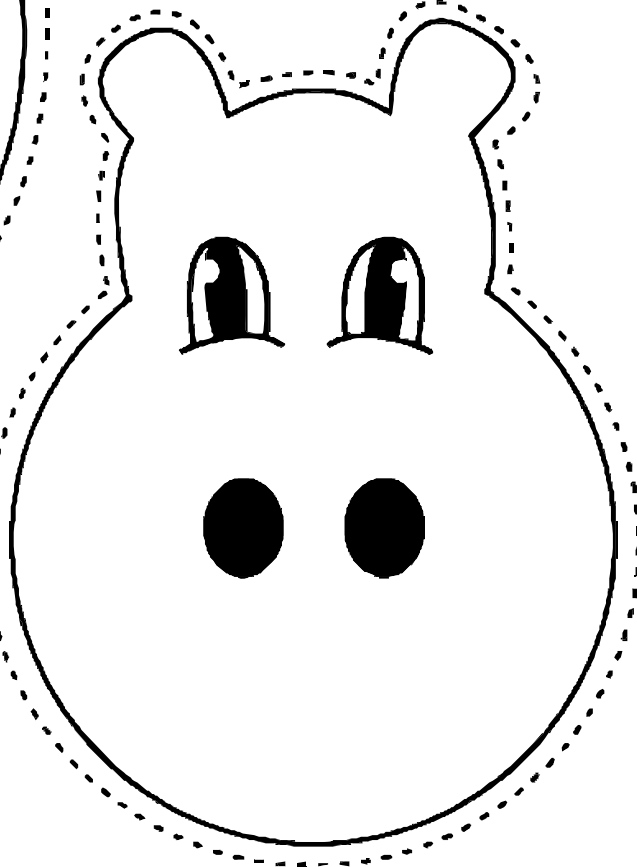
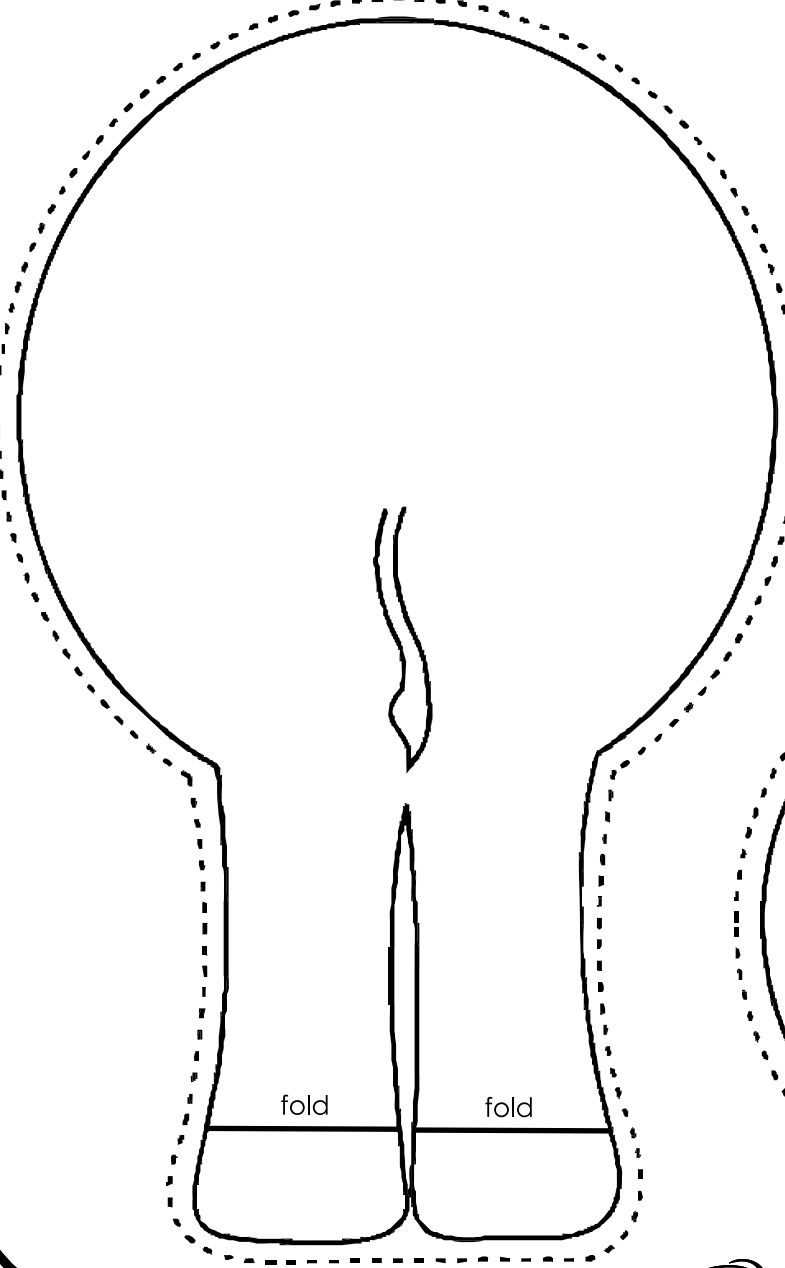
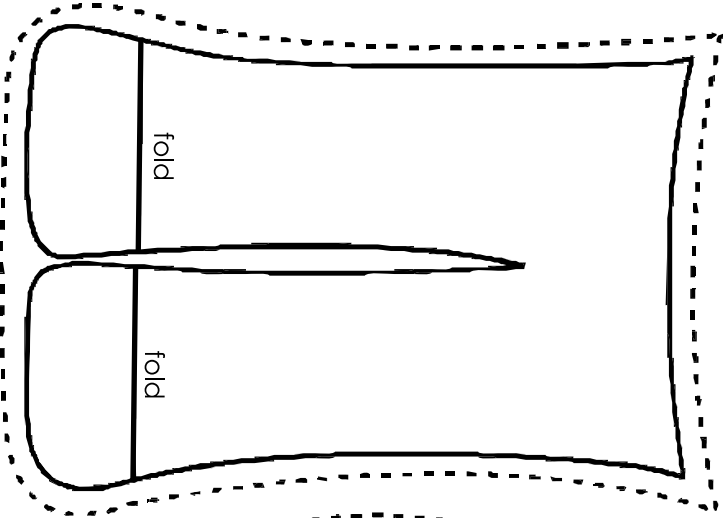

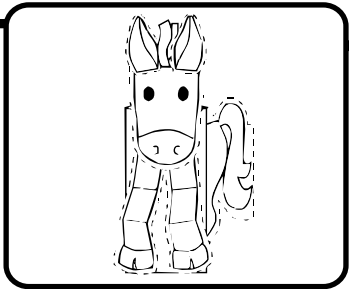

HORSE

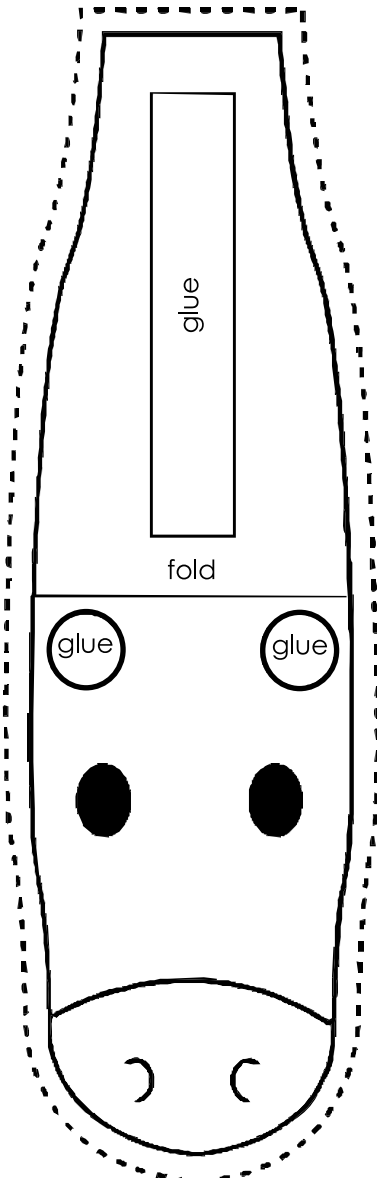
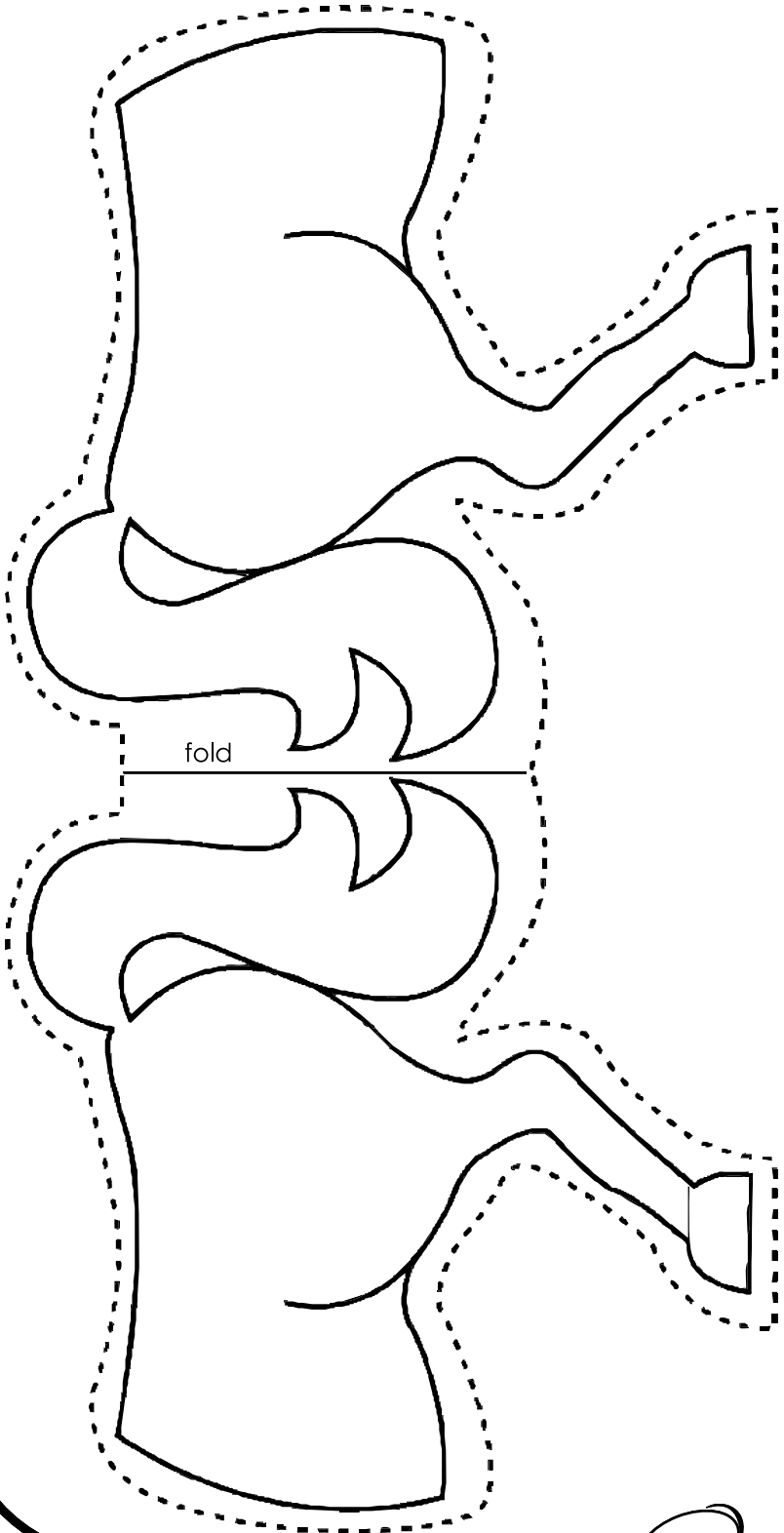

Use with p. 171

PAPER TUBE

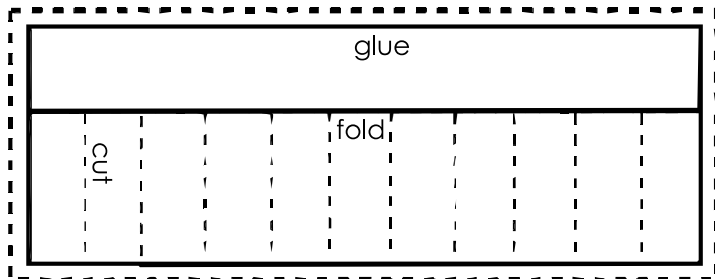
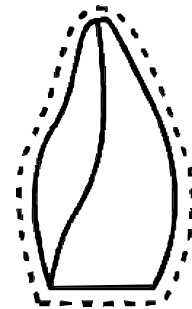
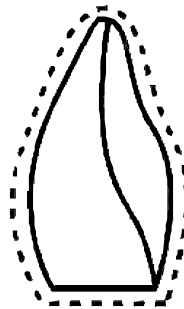
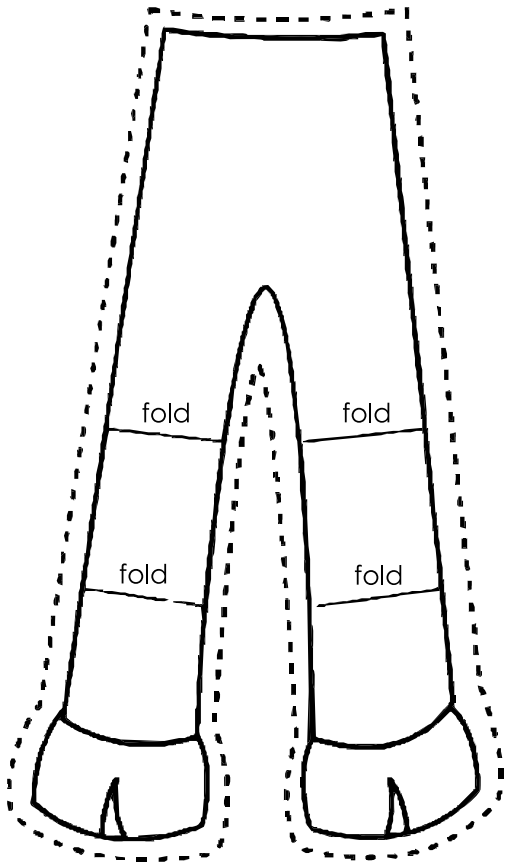

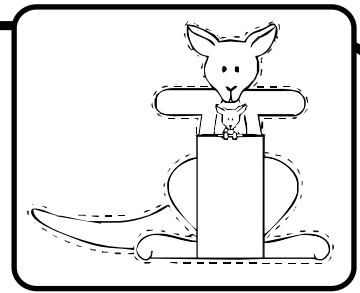

KANGAROO

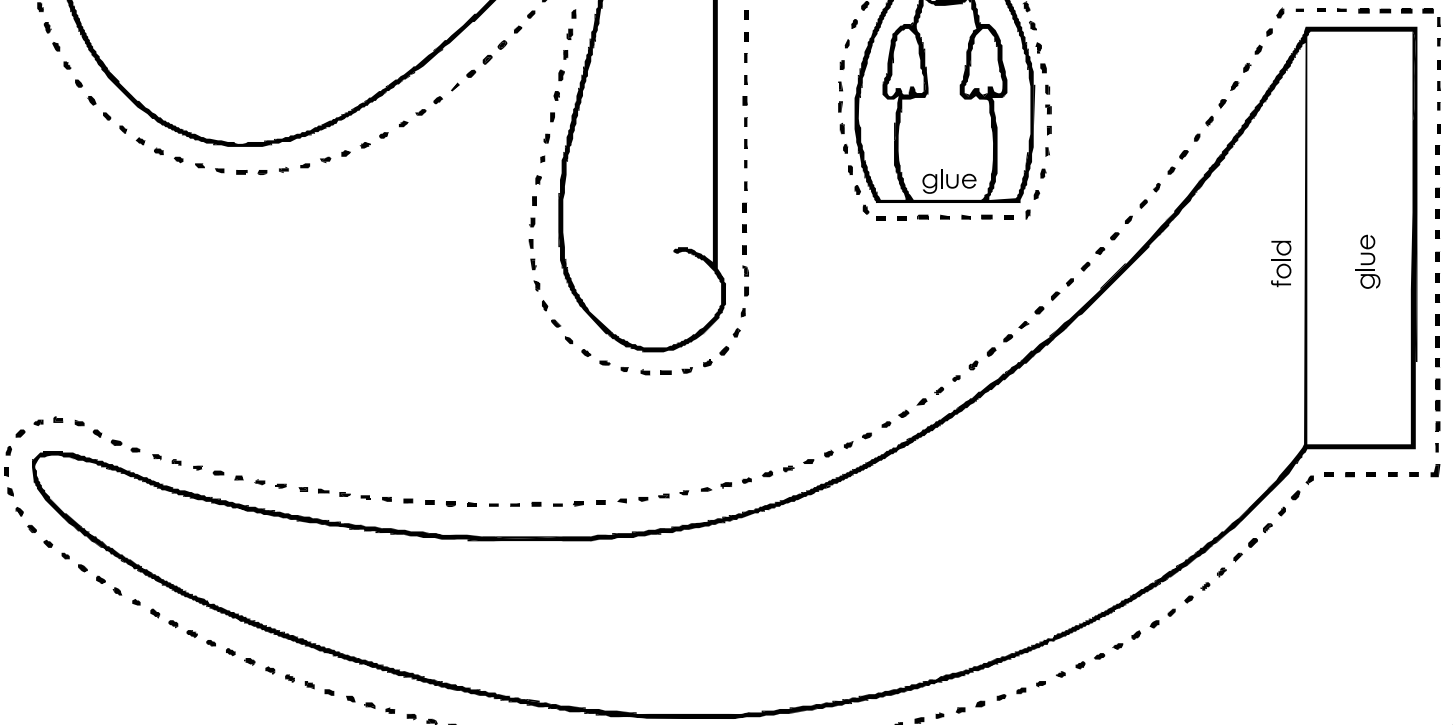
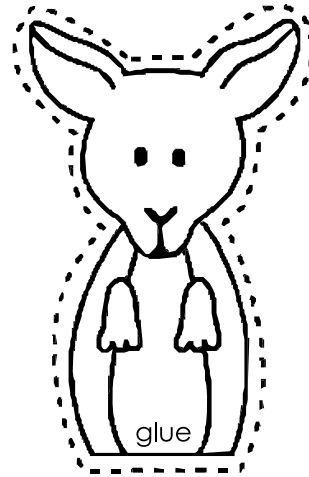
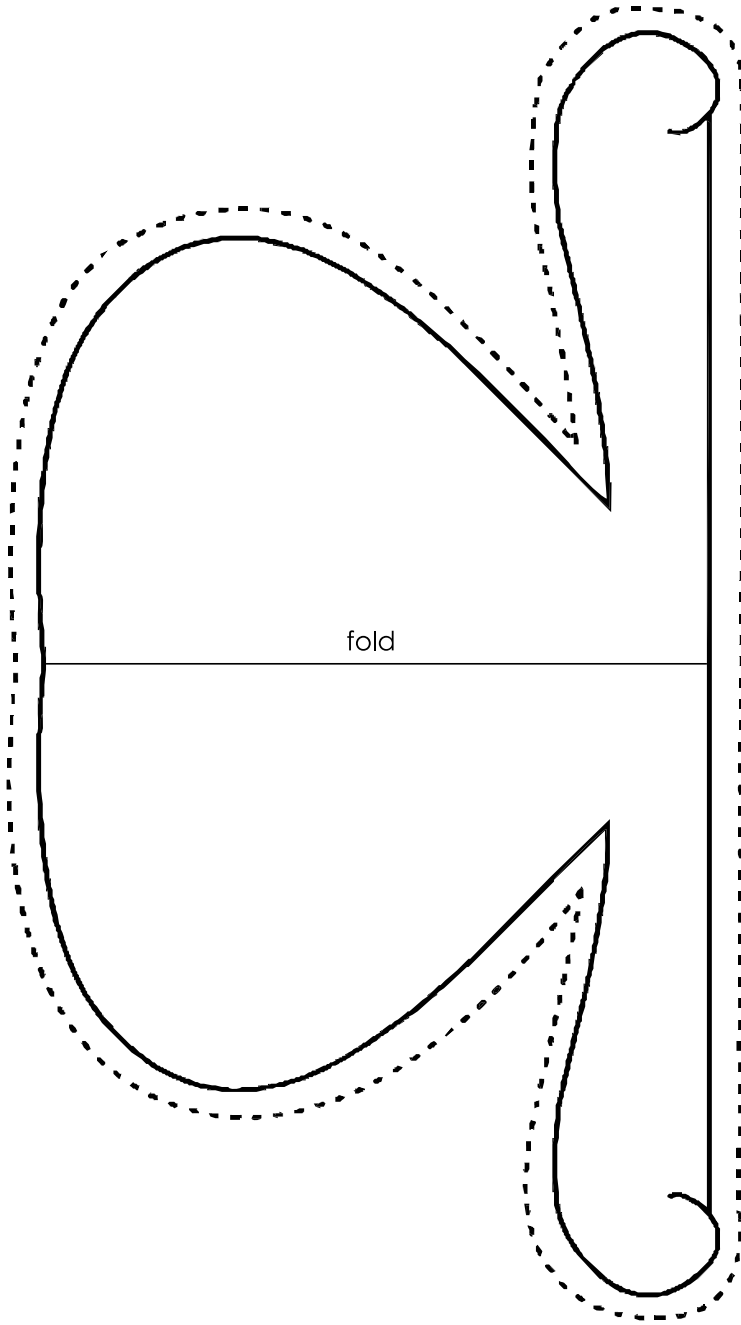

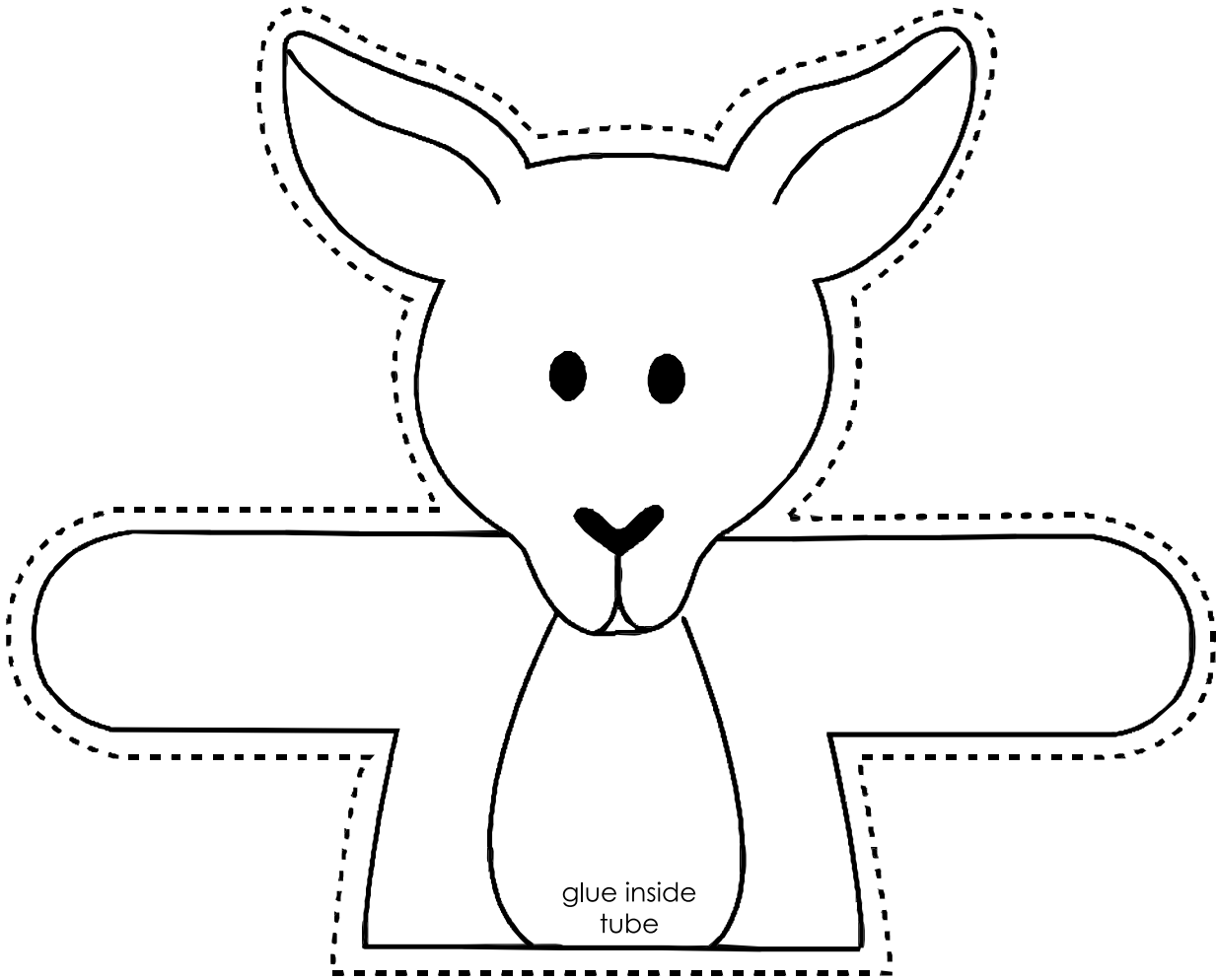

glue inside
tube



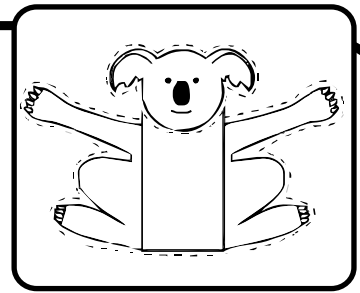

KOALA

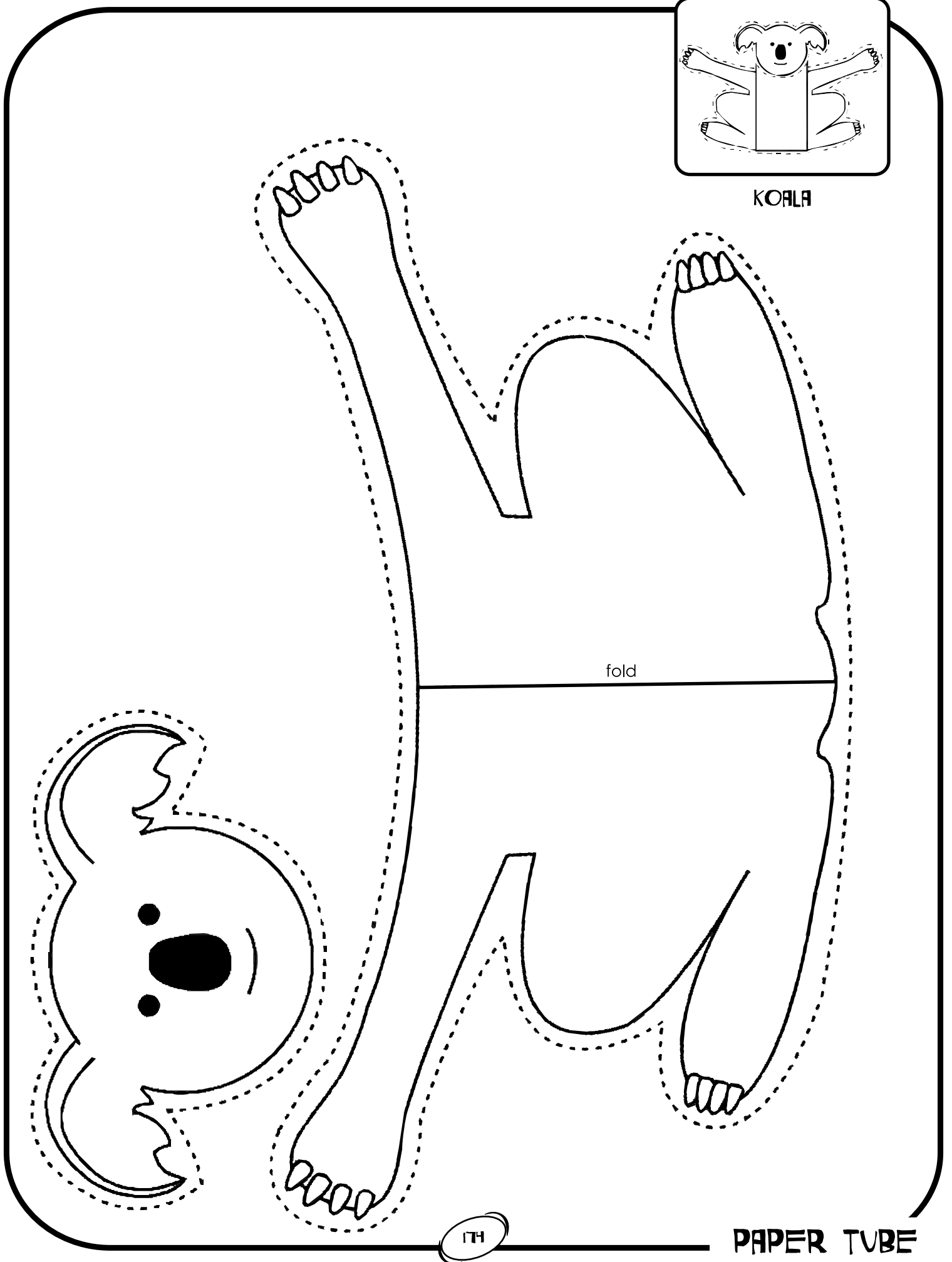

174

PAPER TUBE

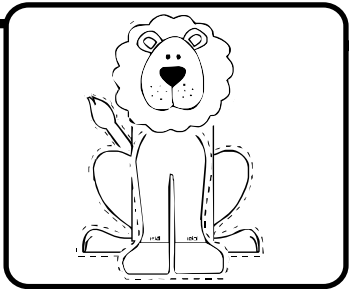

LION

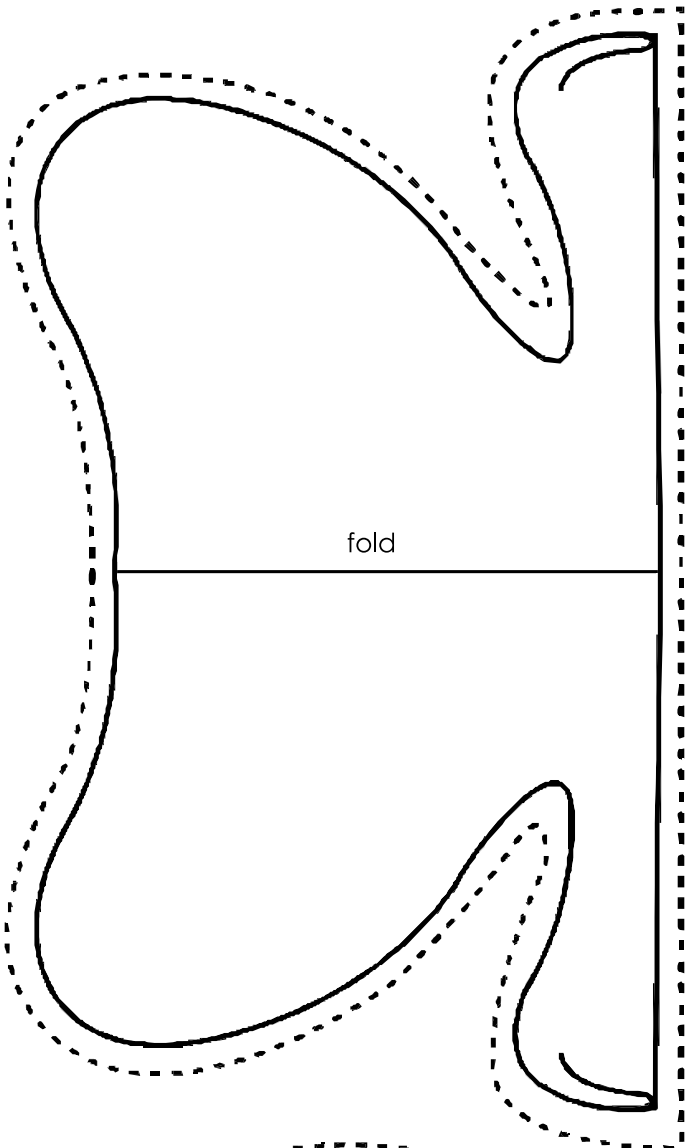

fold

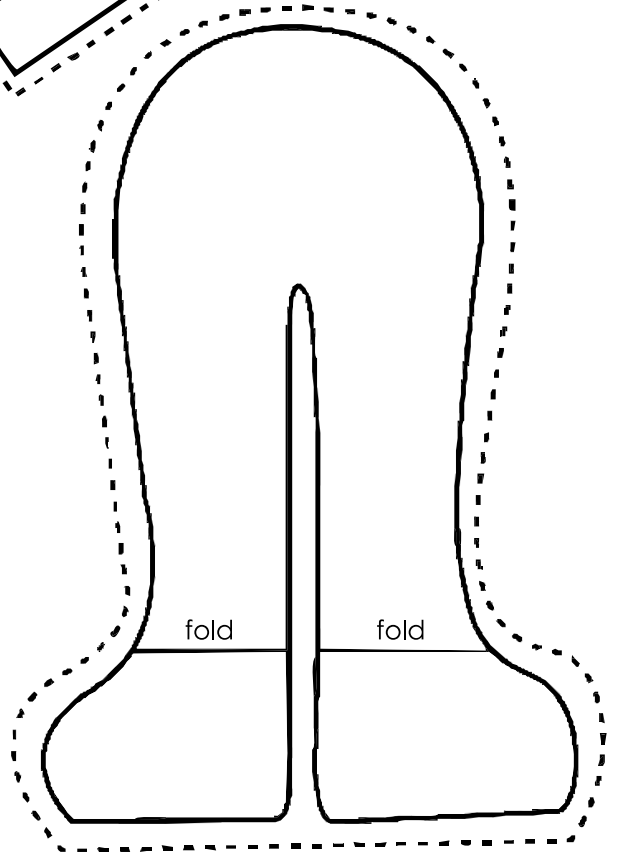
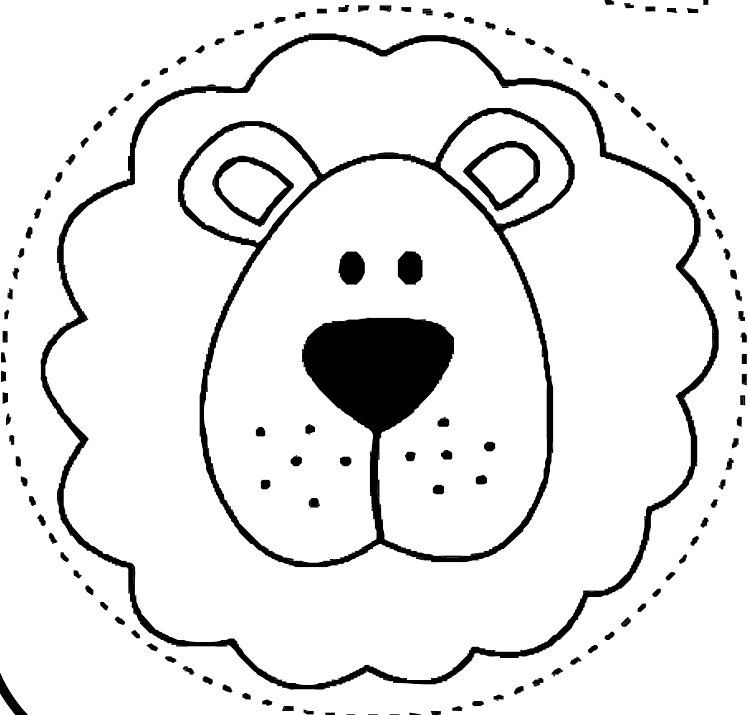
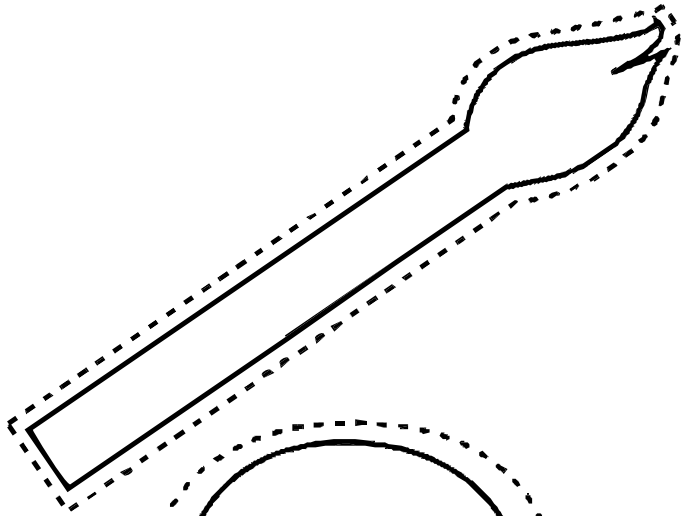

fold

fold

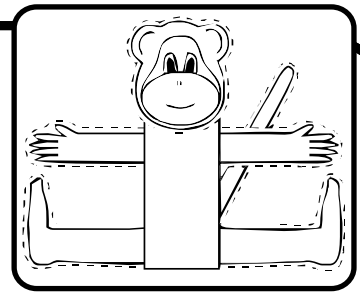

MONKEY

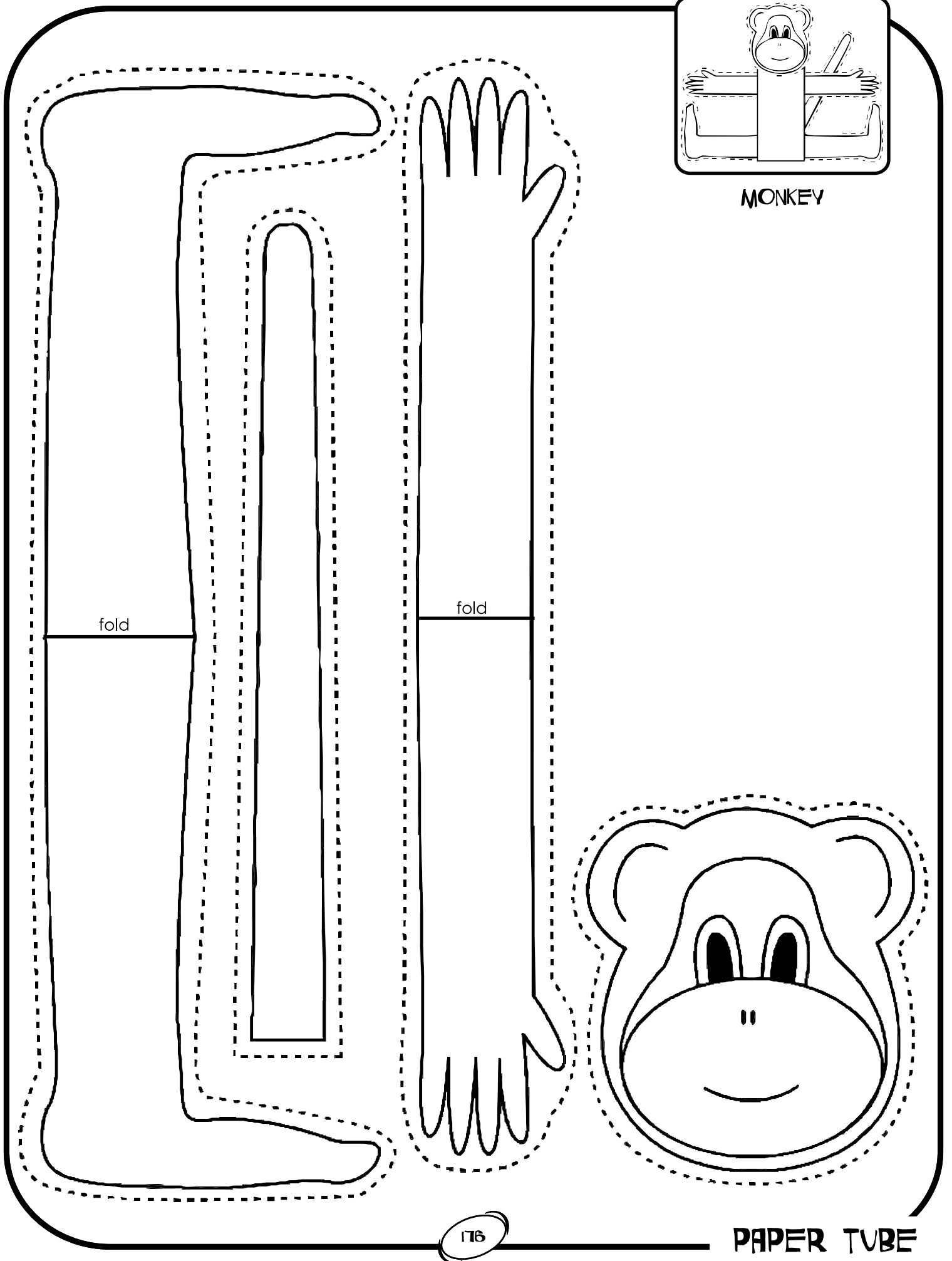

fold

fold

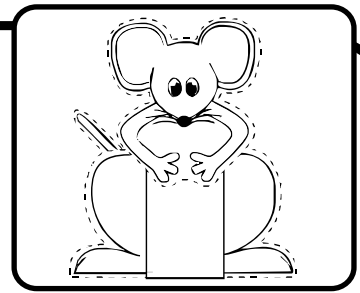

MOUSE

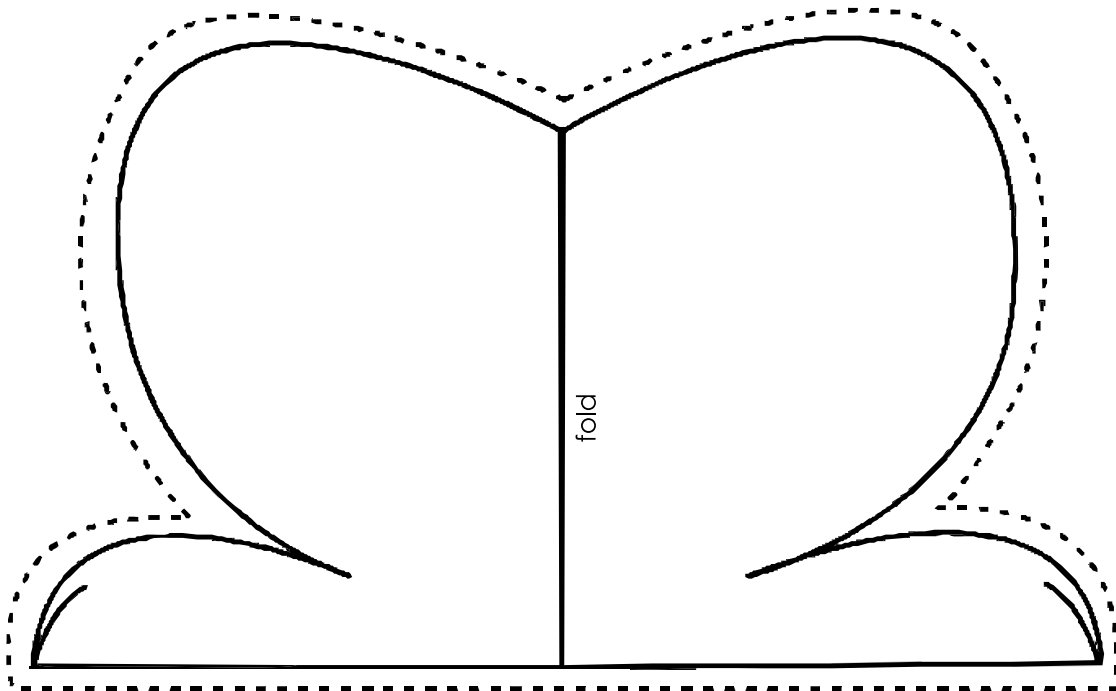
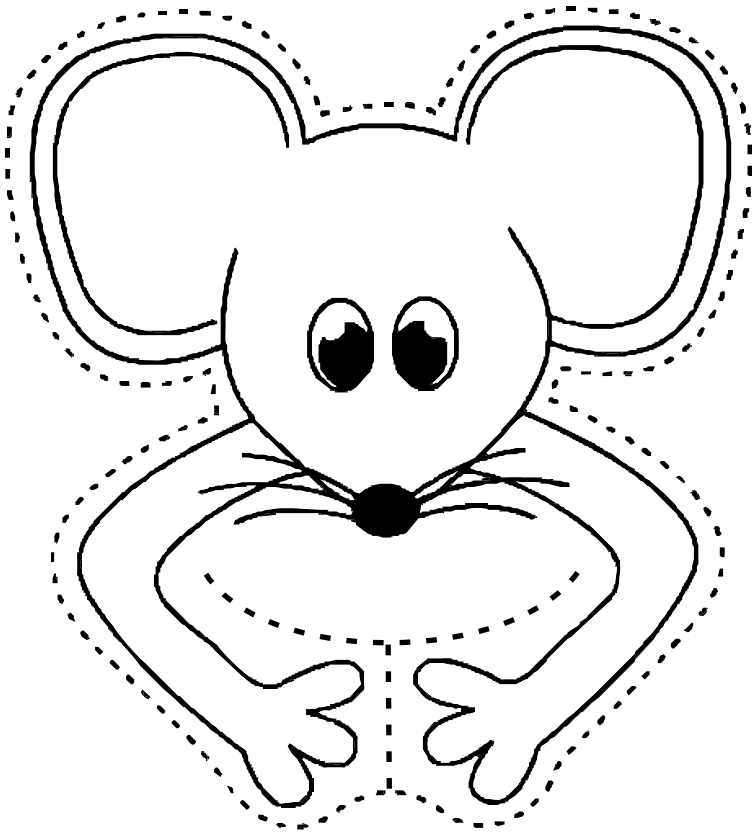

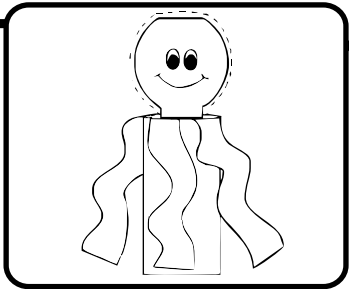

OCTOPUS

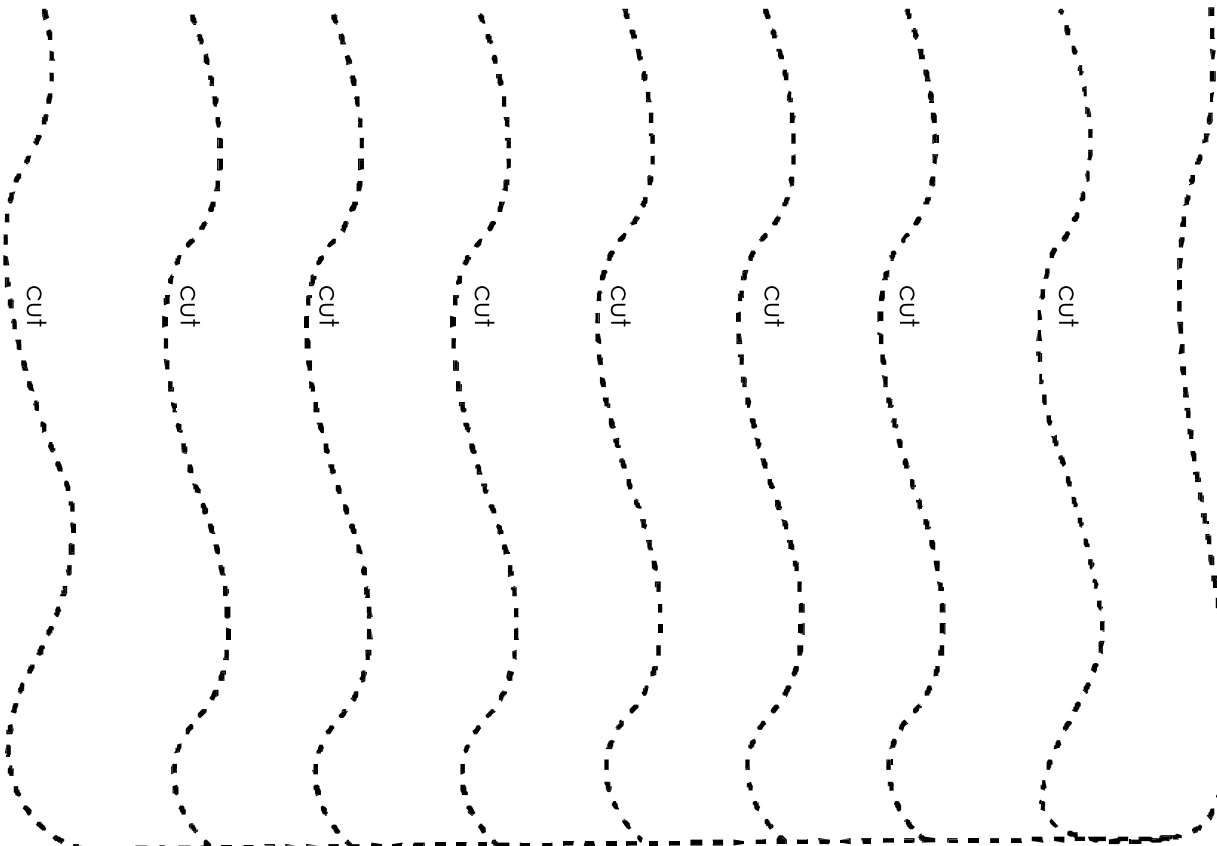
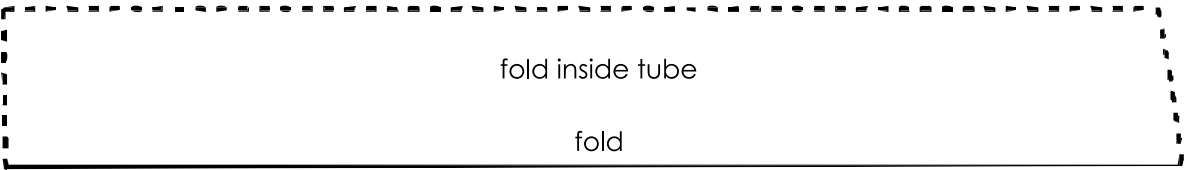
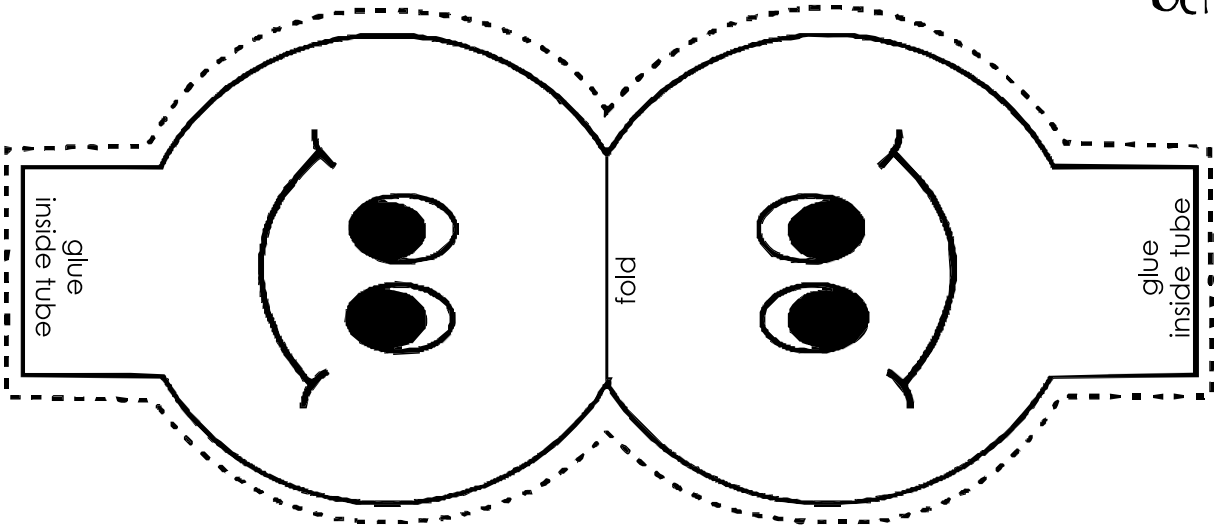

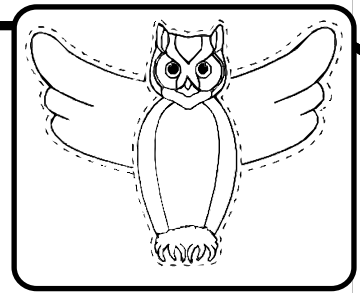

OWL

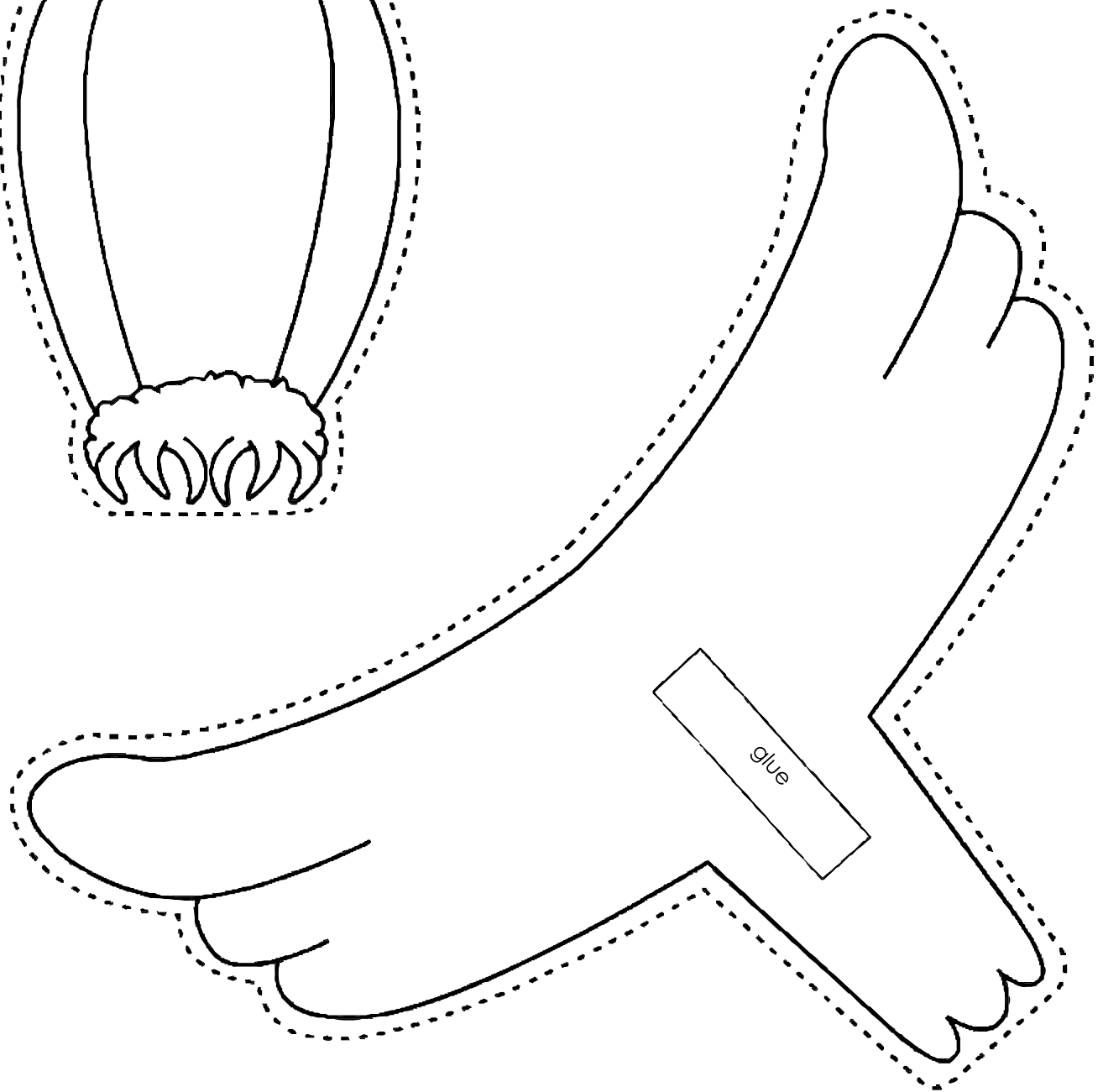
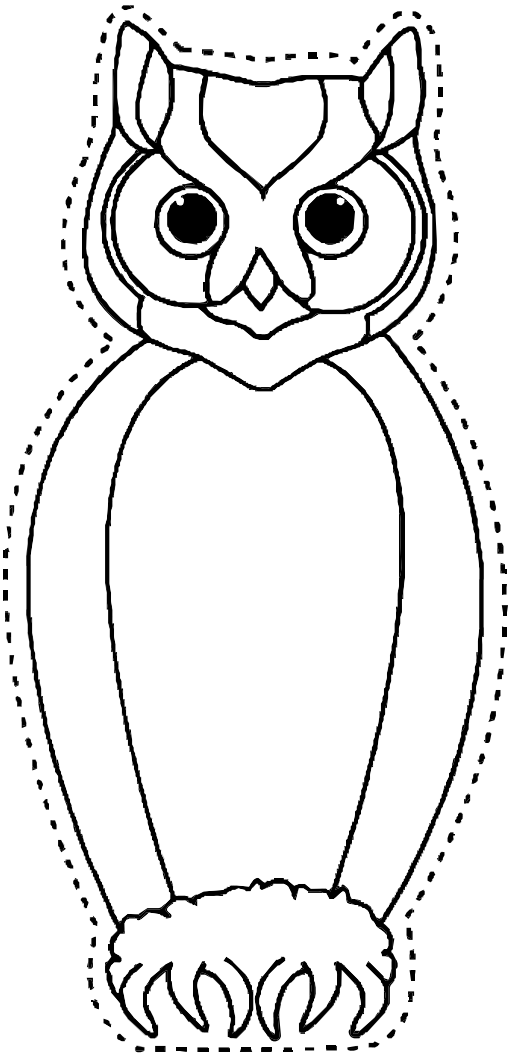

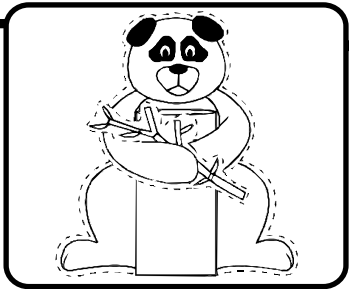

PANDA

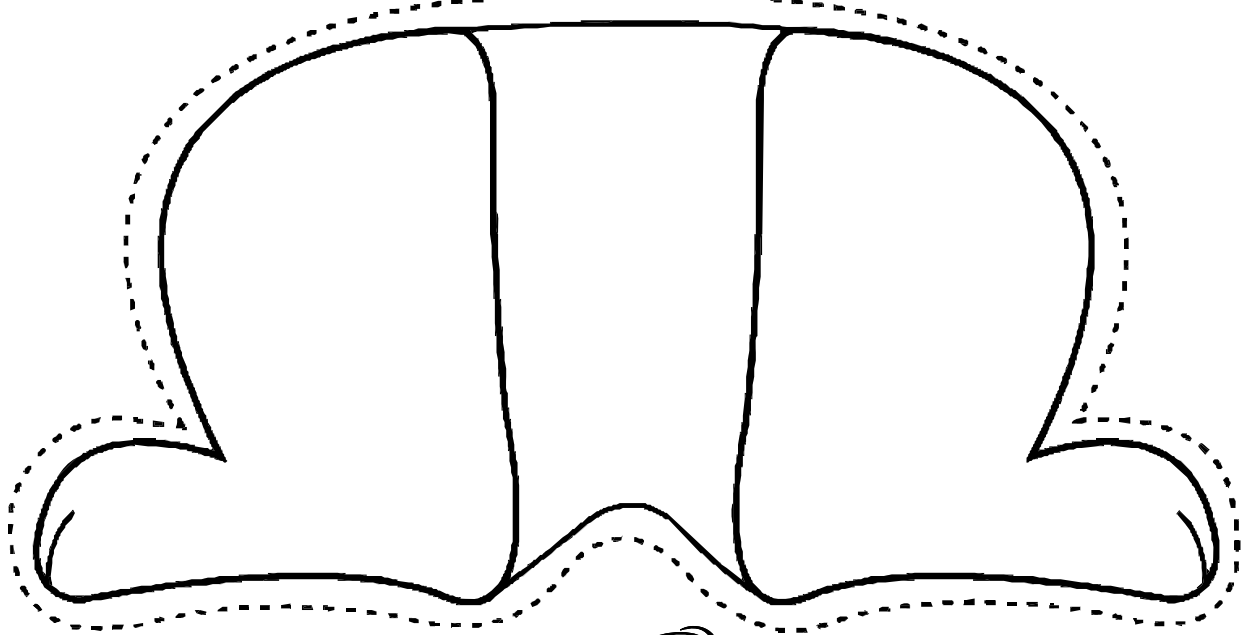
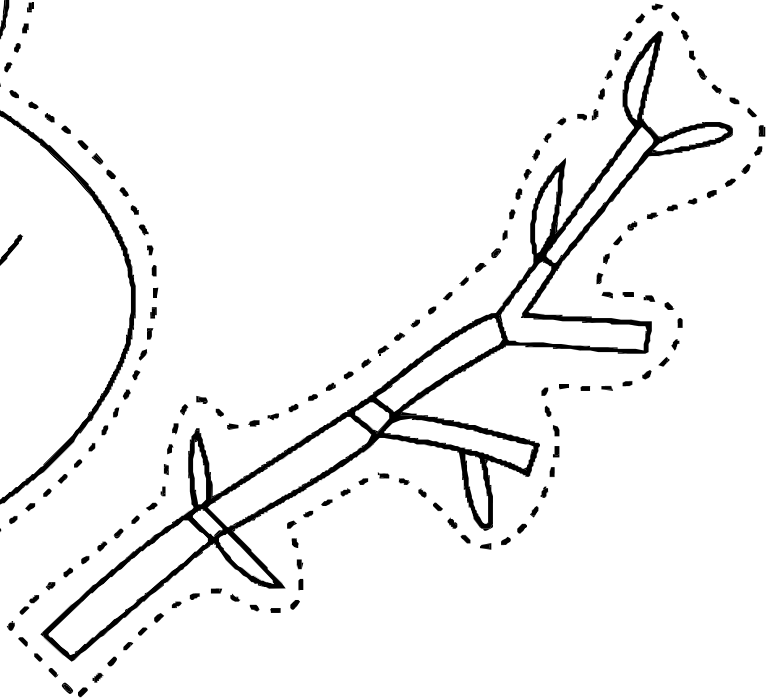
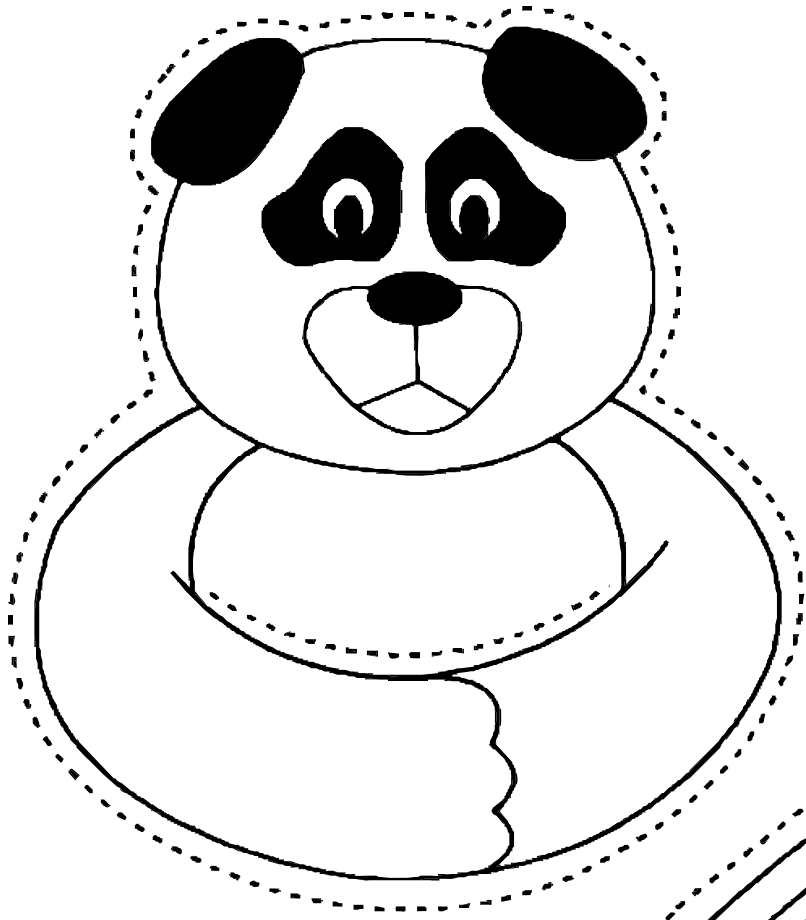

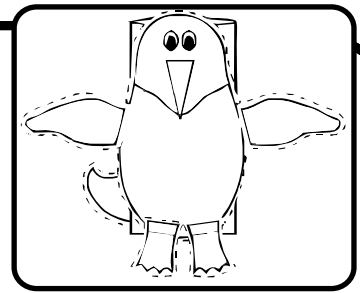

PENGUIN

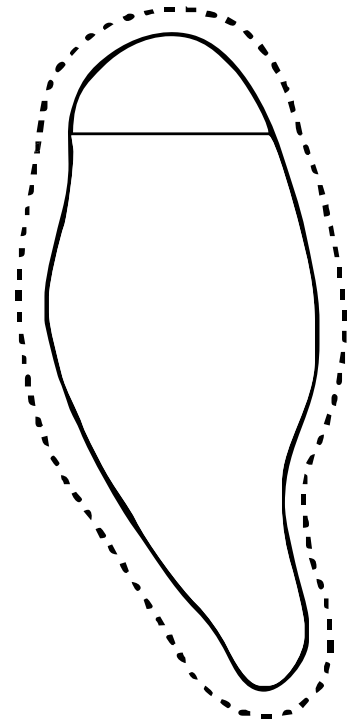
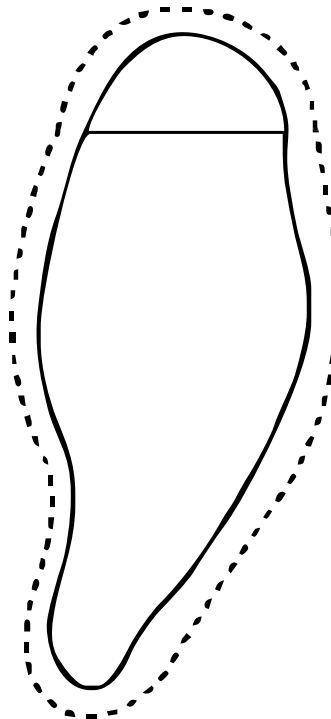
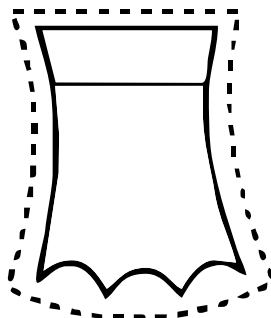
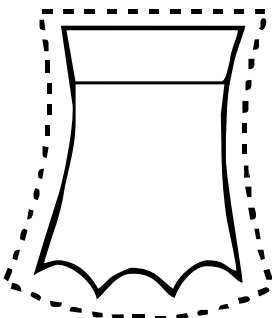
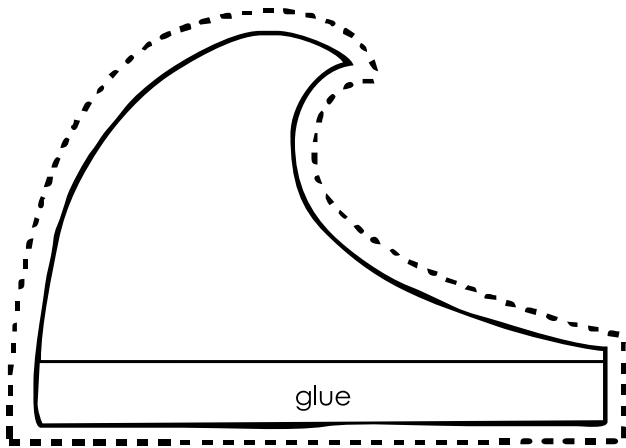
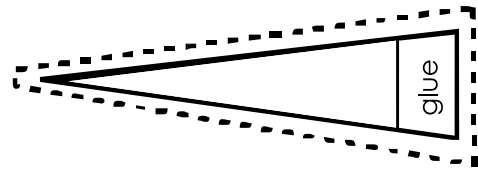
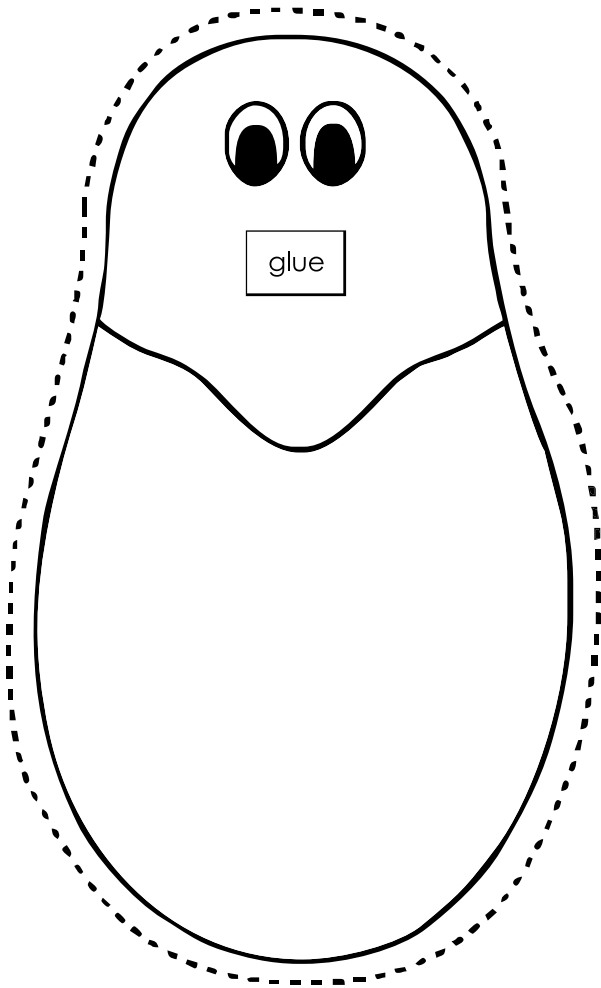

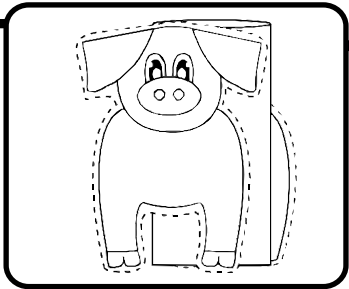

PIG

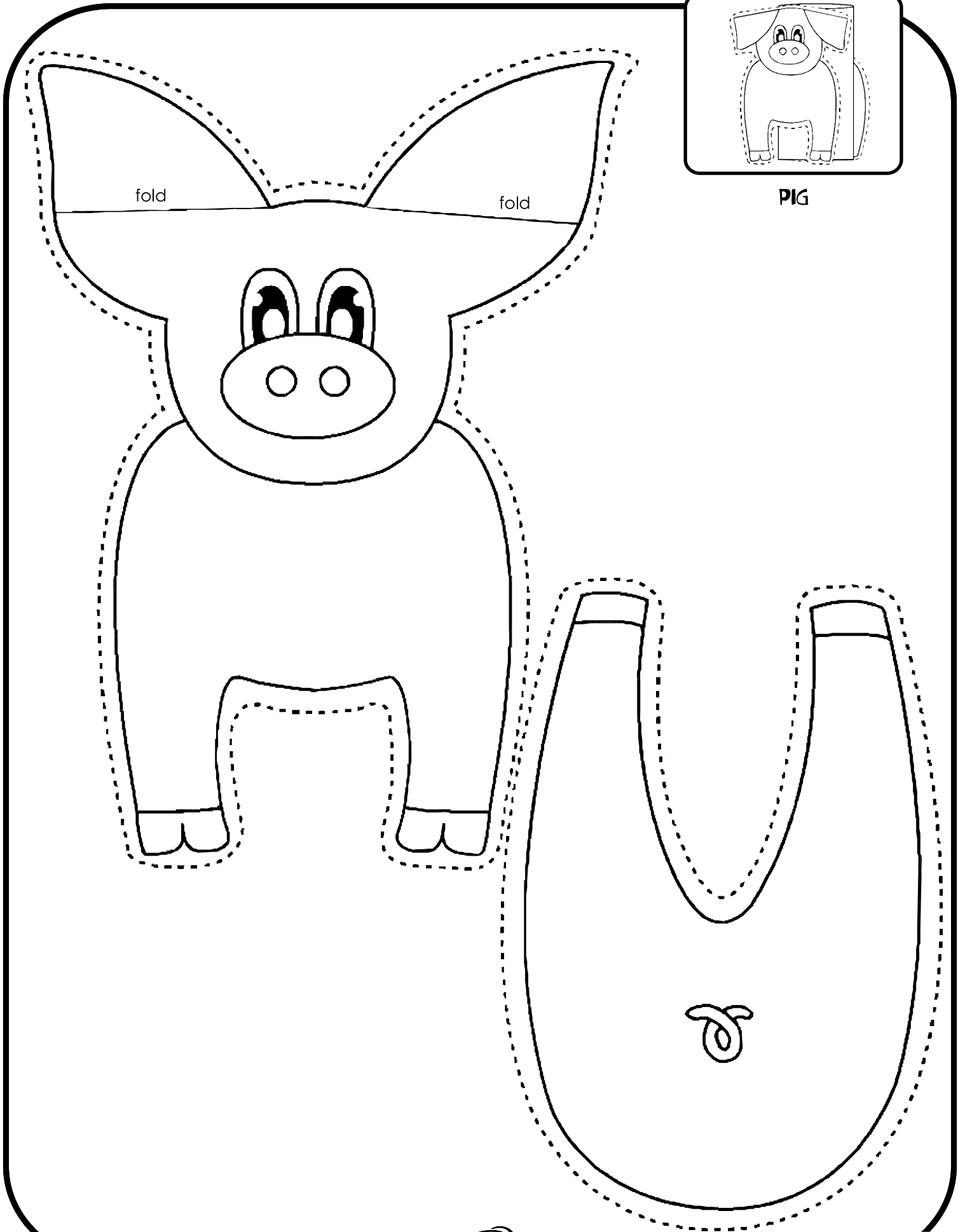

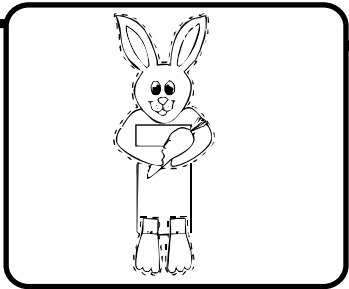

RABBIT

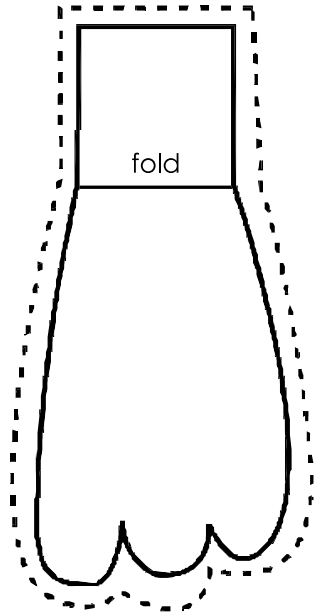
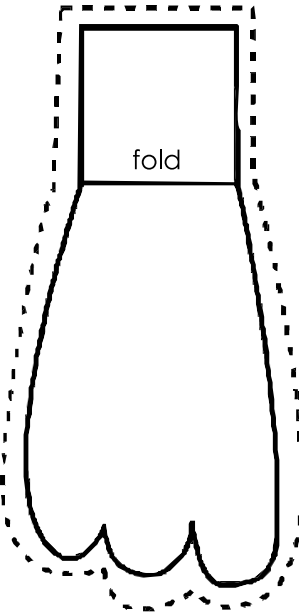
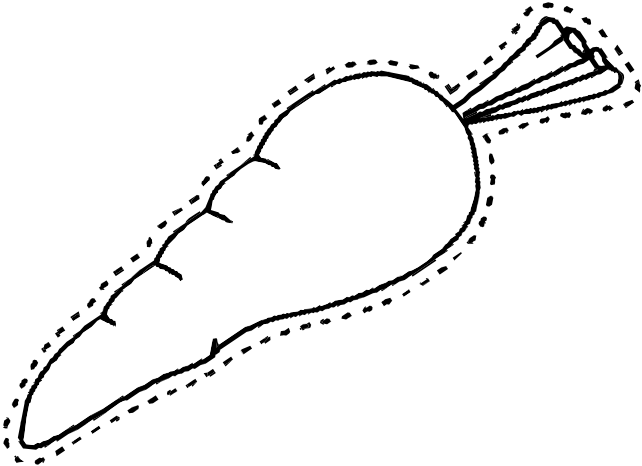
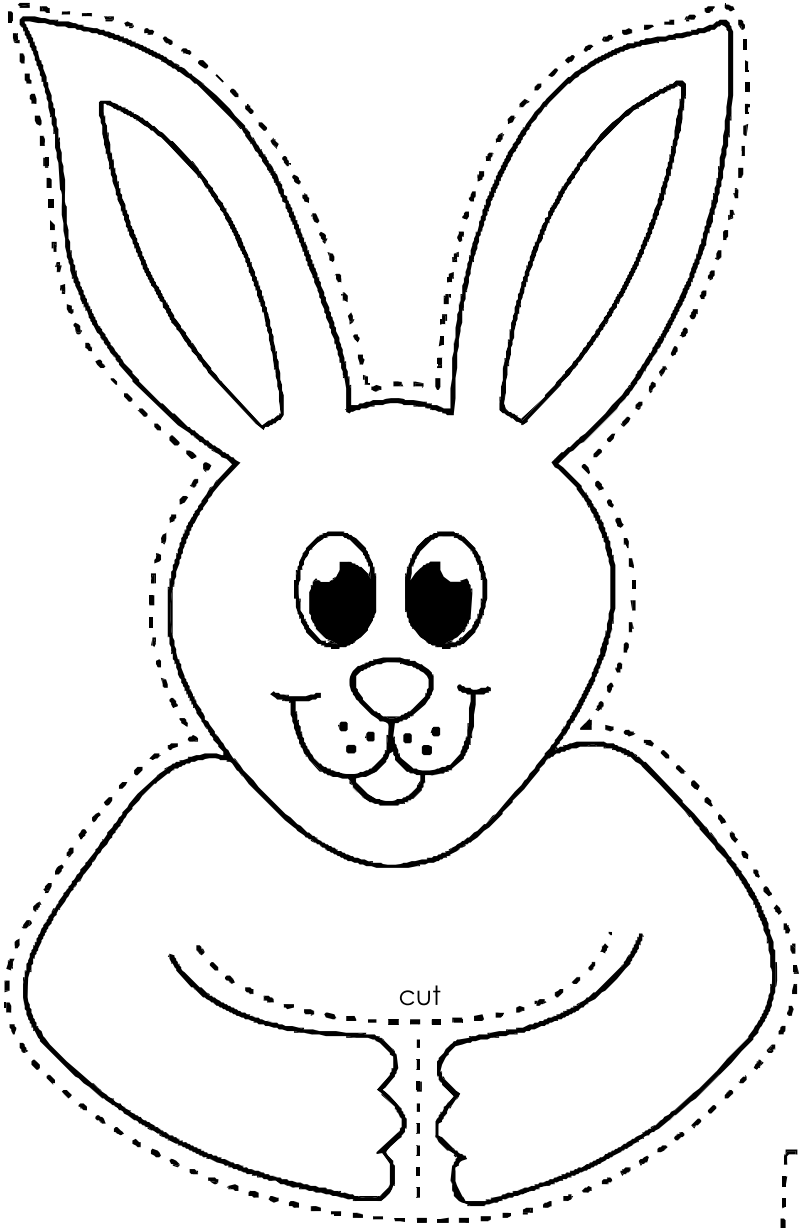

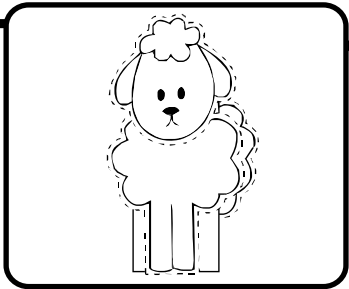

SHEEP

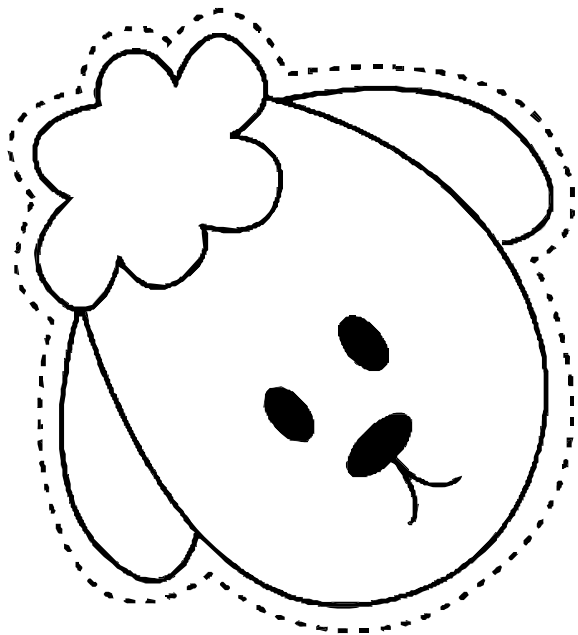
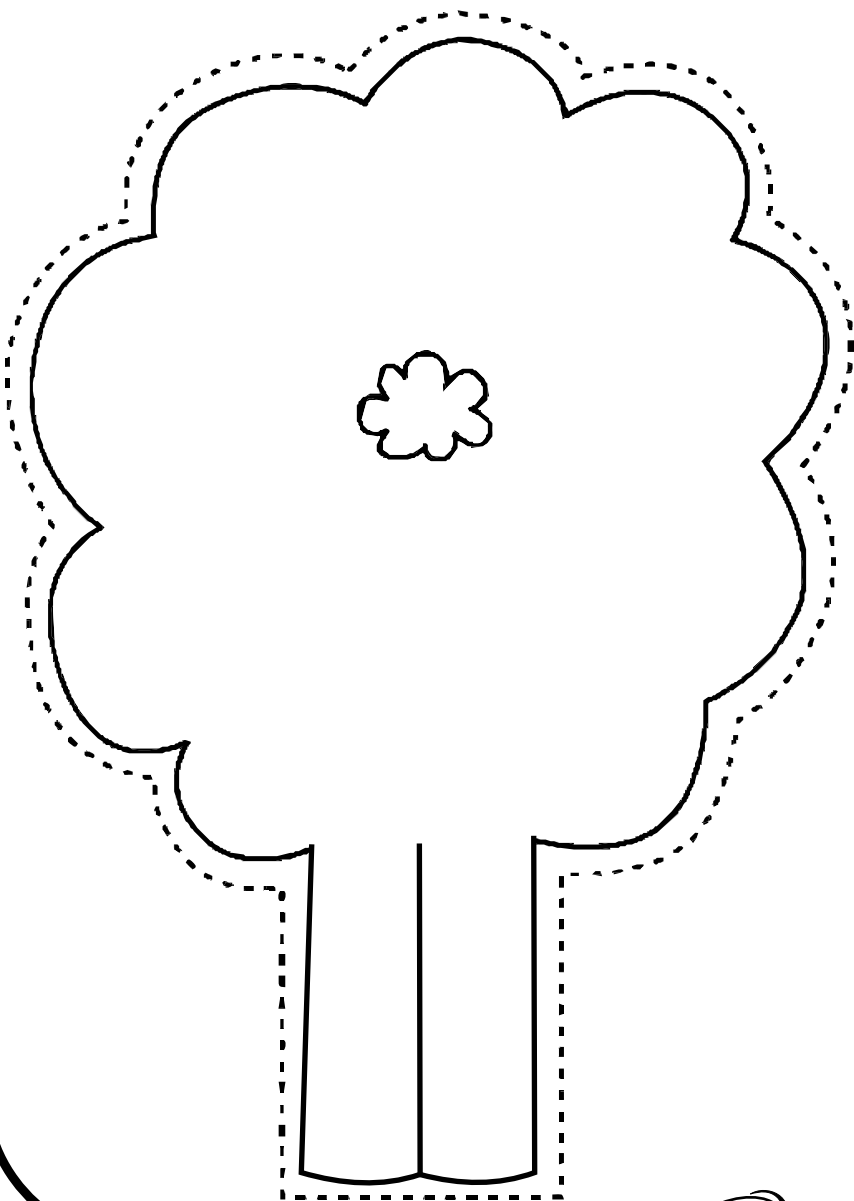
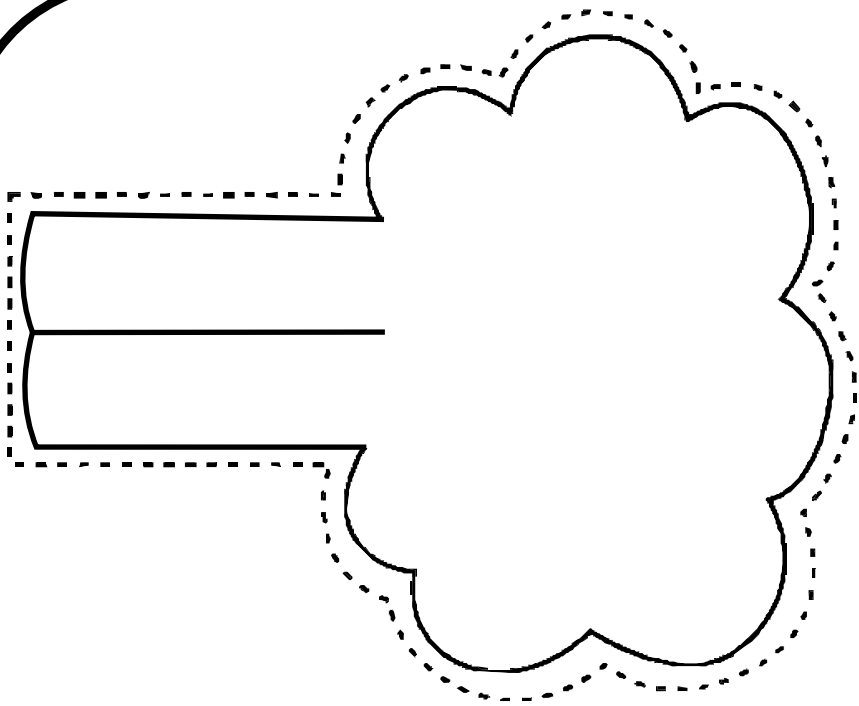

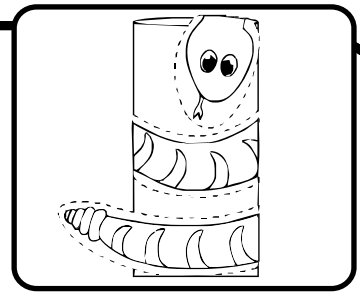

SNAKE

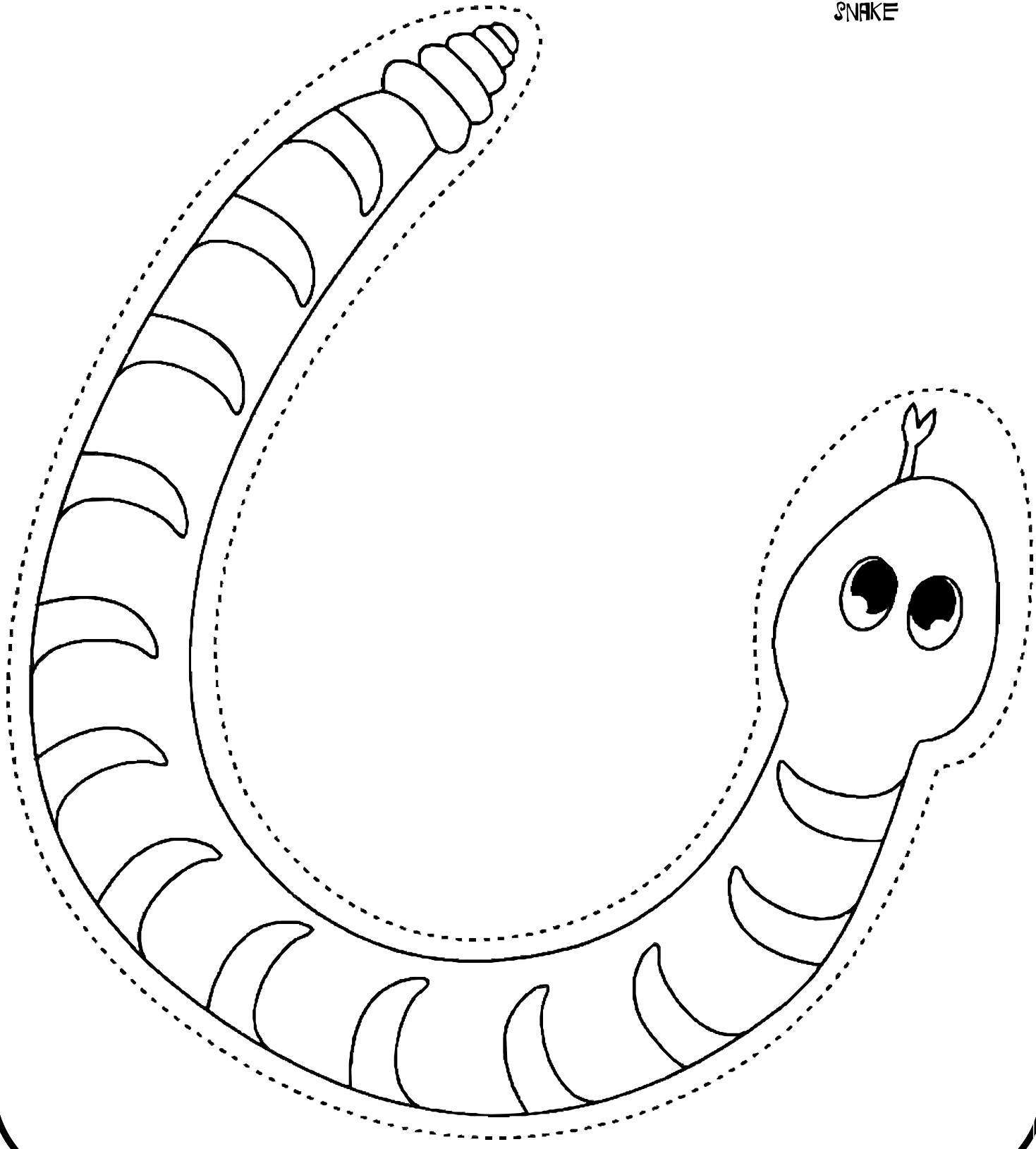

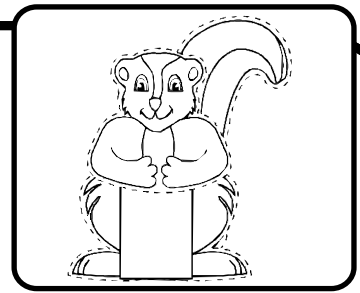

SKUNK

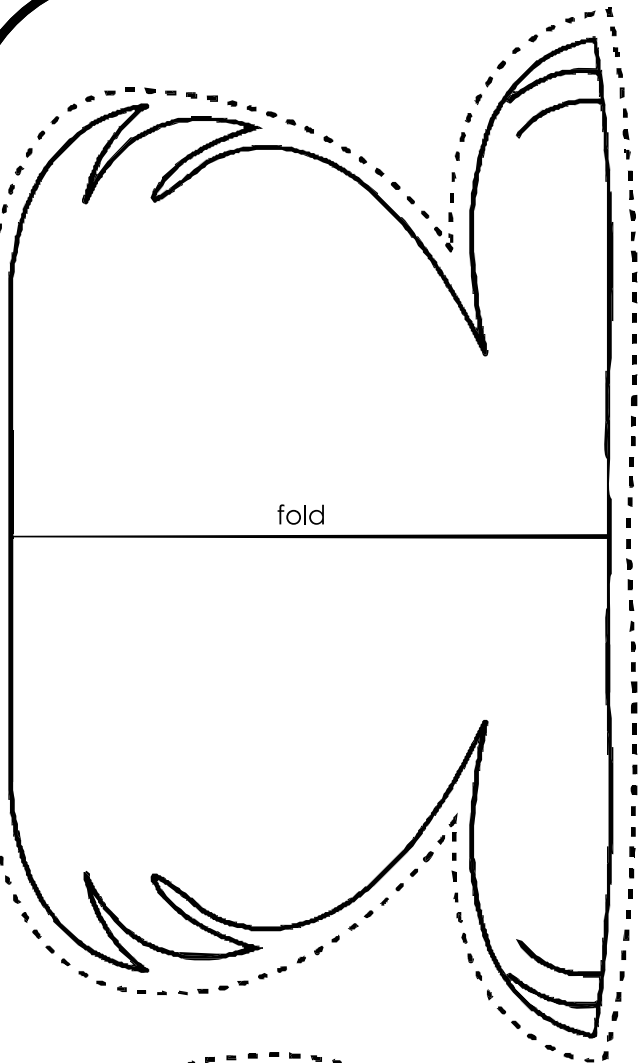

fold

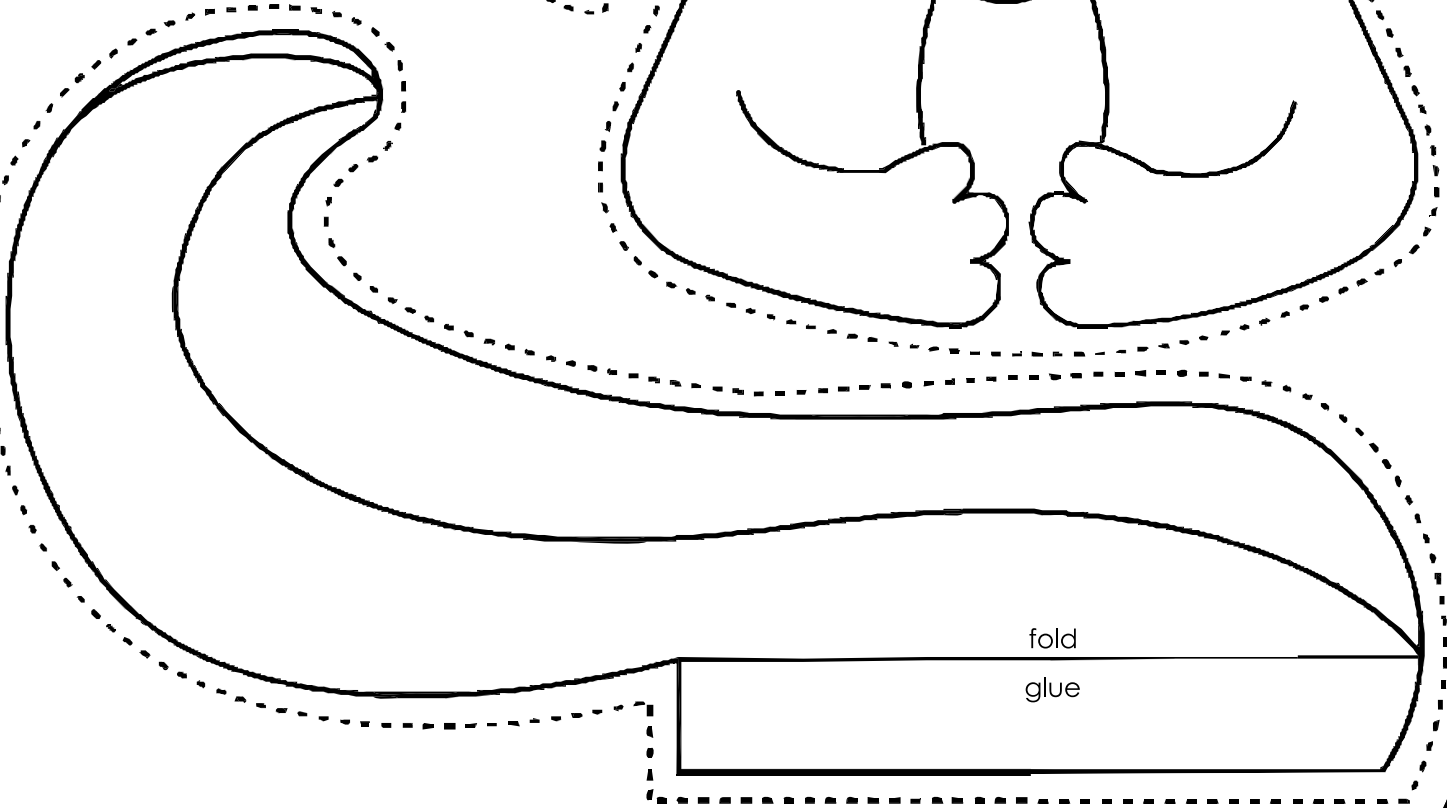
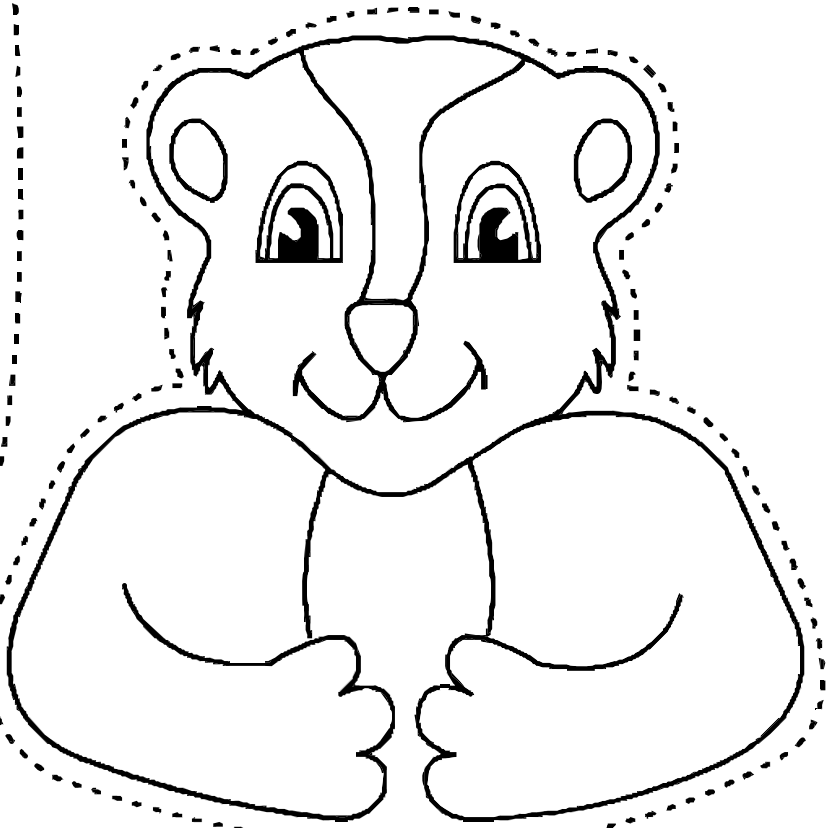

fold

glue

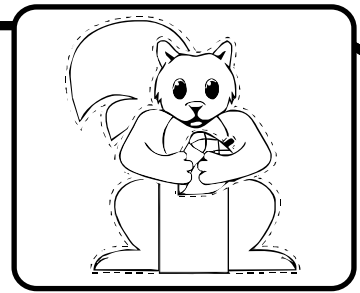

SQUIRREL

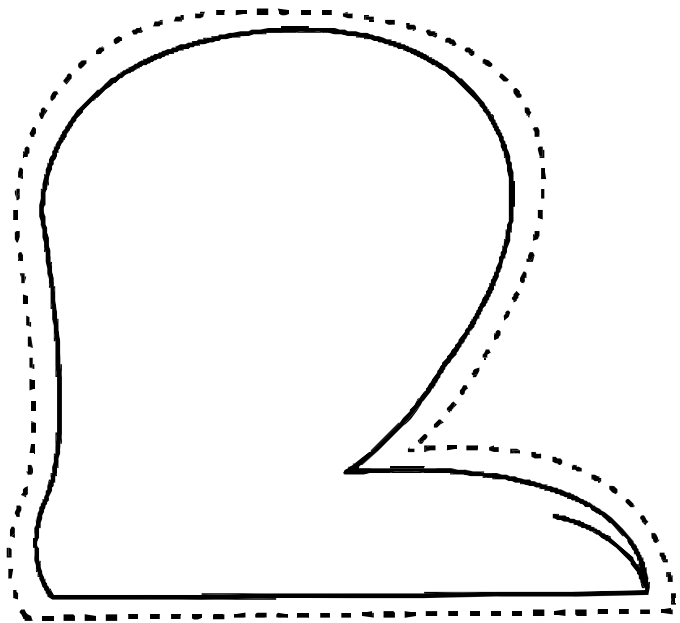
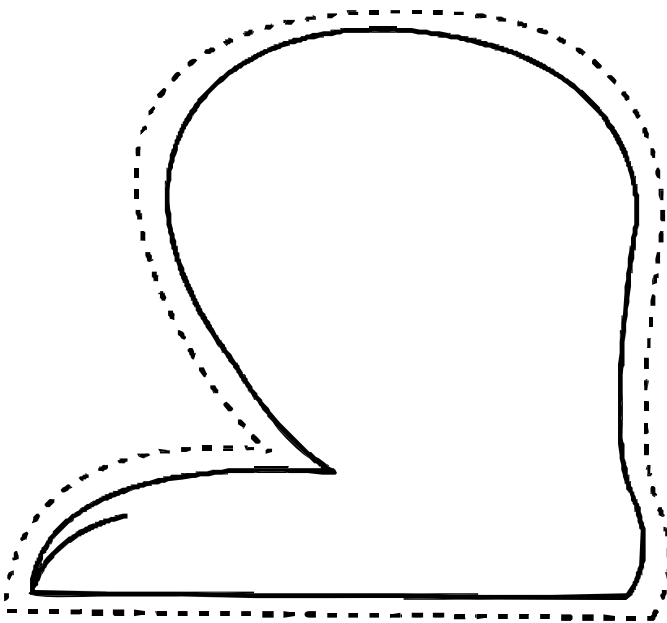
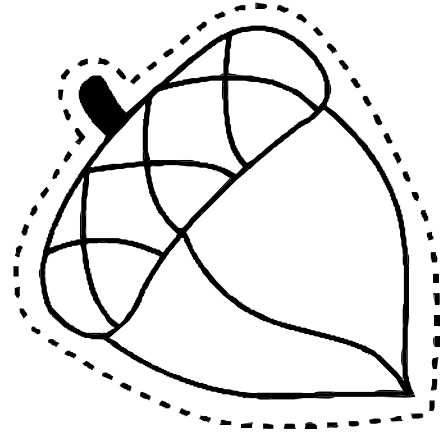
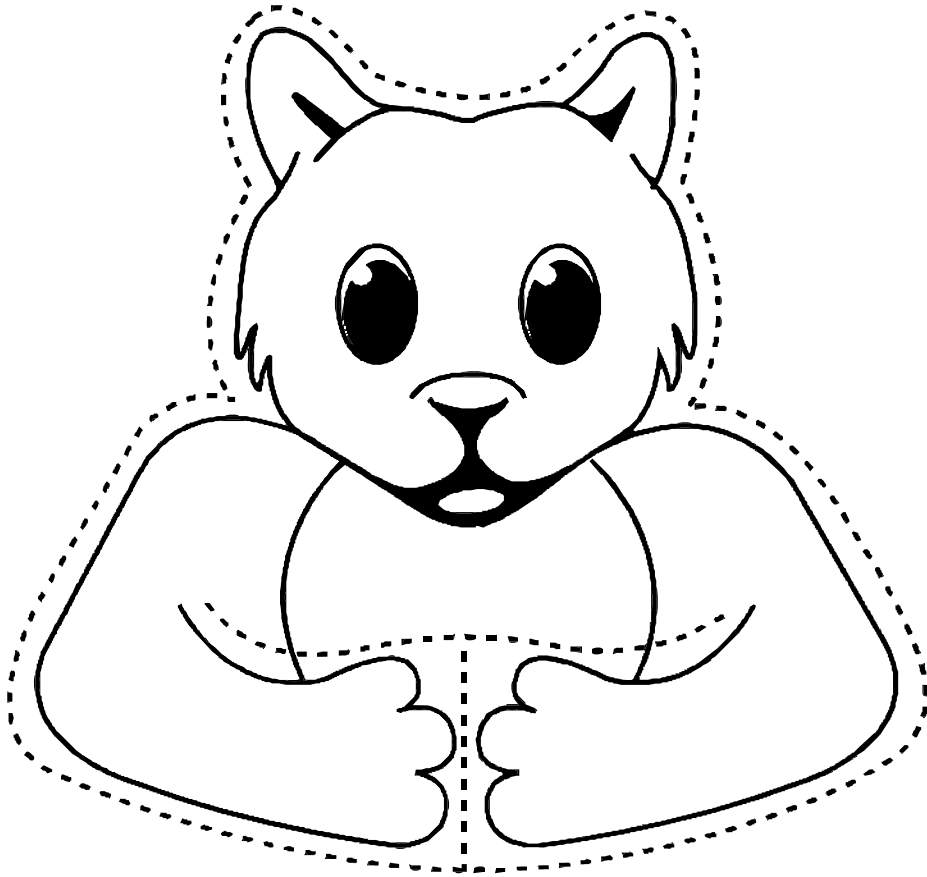

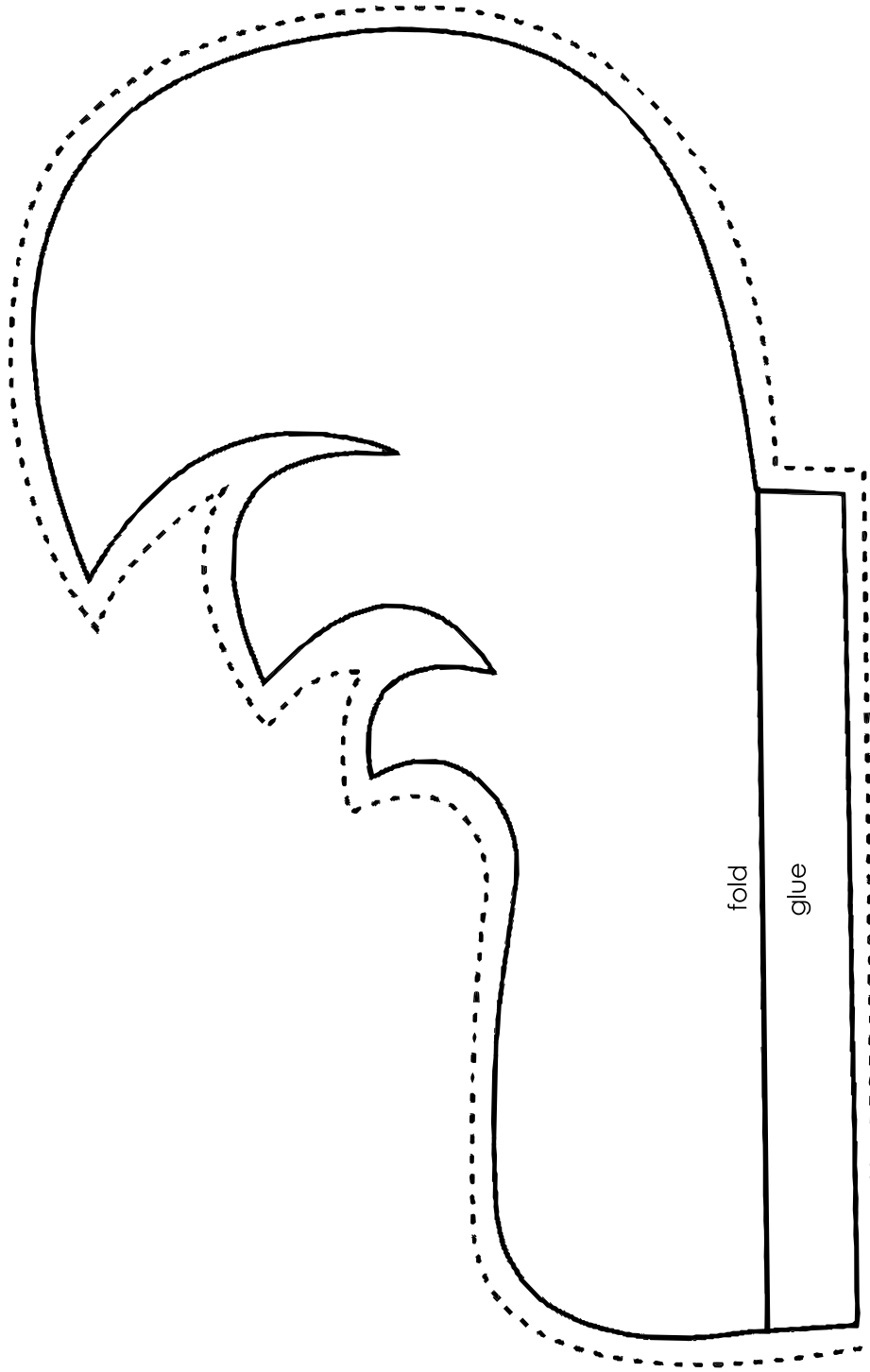

Use with p. 187

PAPER TUBE

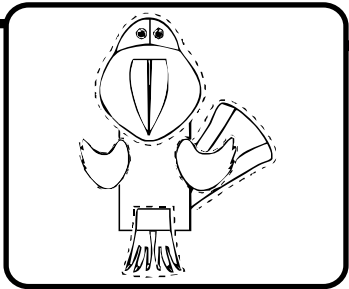

TOUCAN

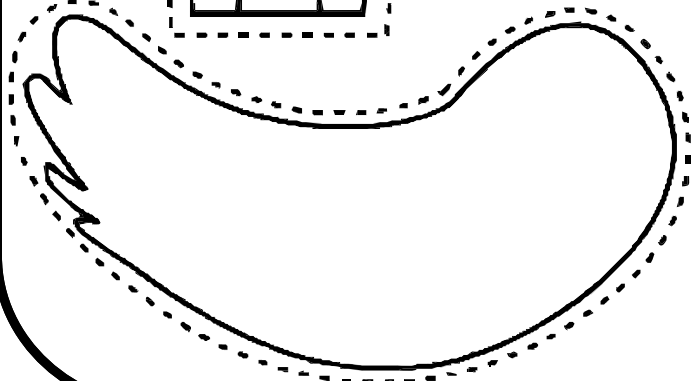
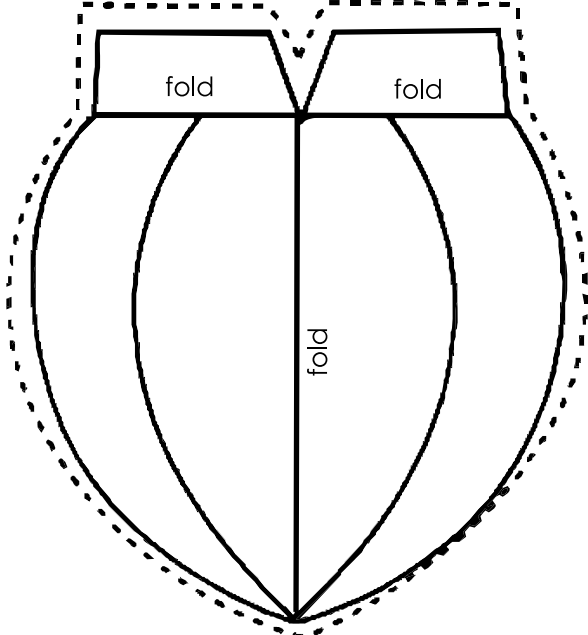
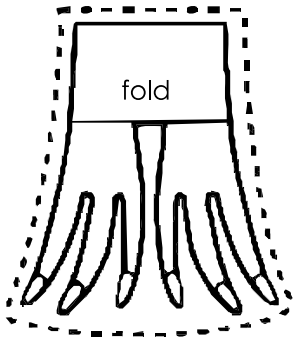
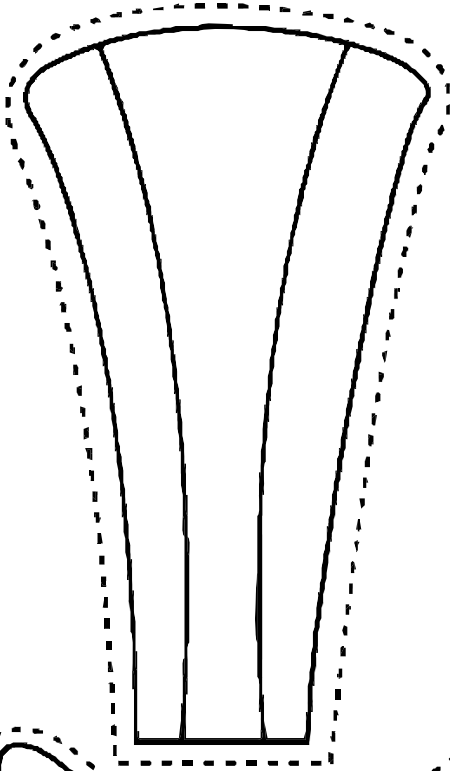
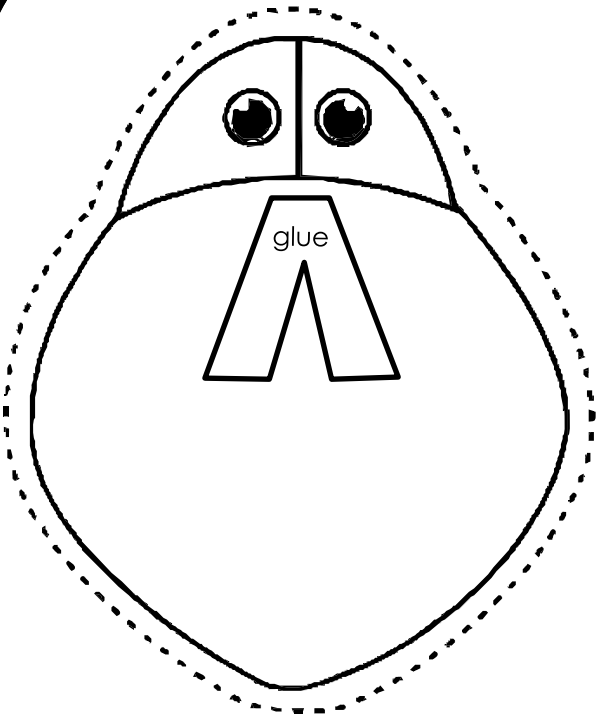

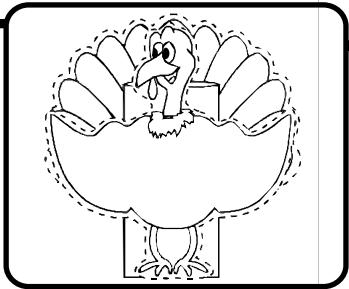

TURKEY

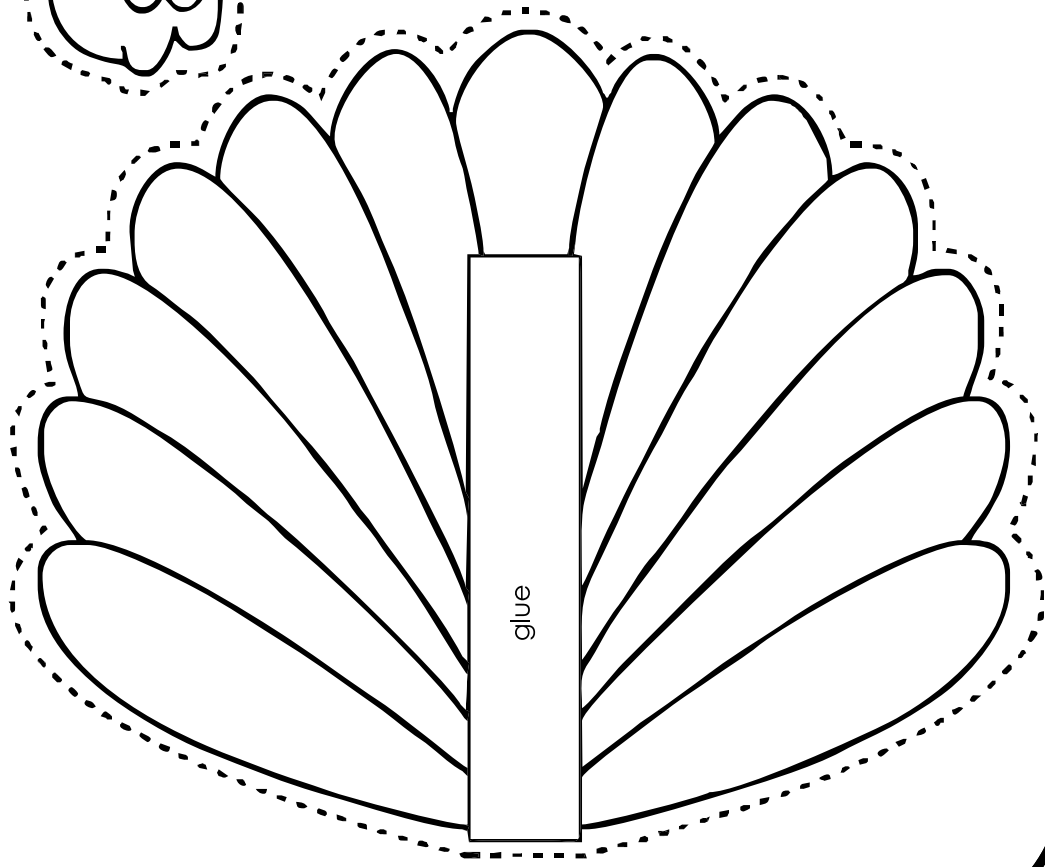
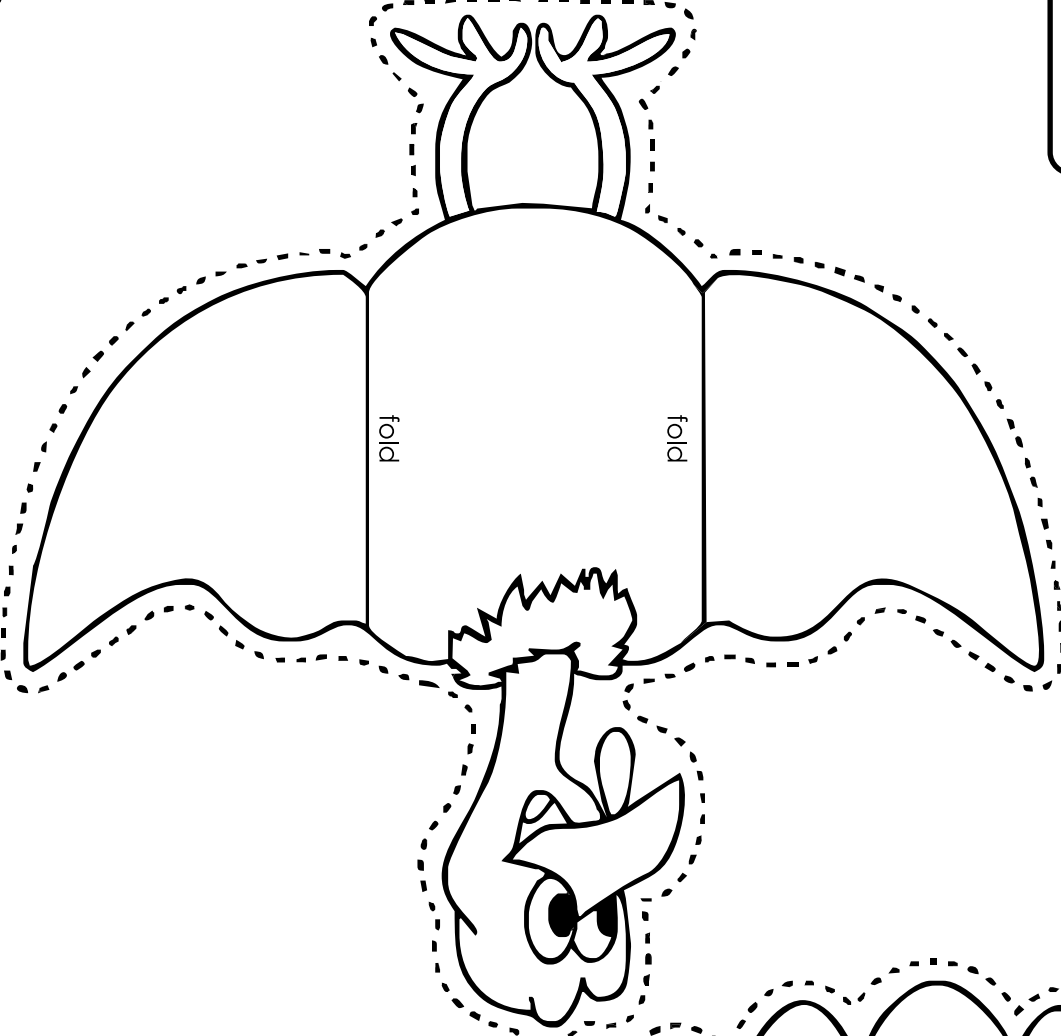

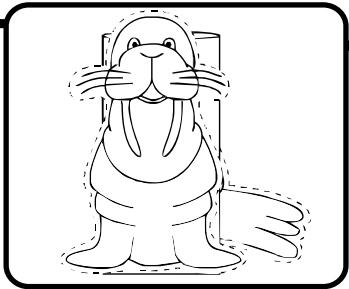

WALRUS

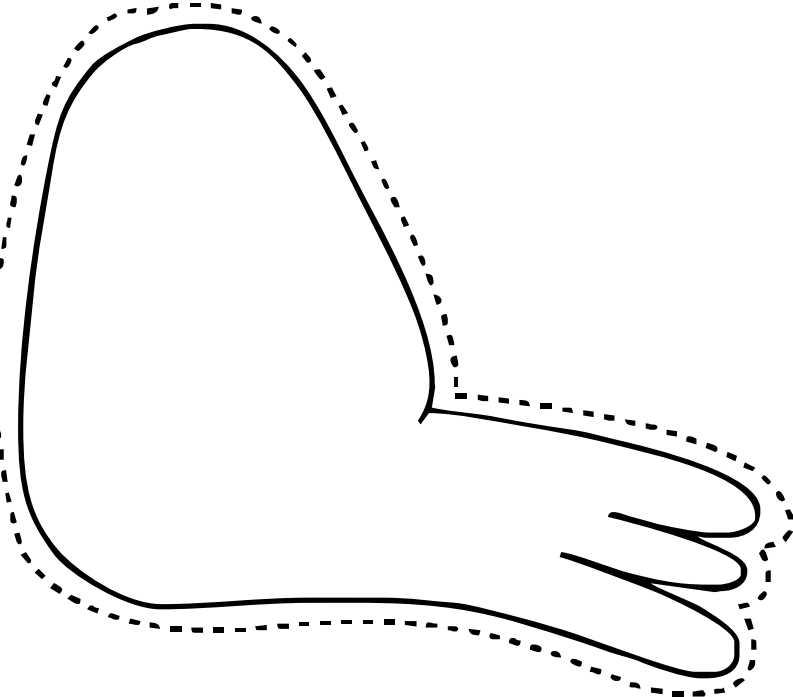
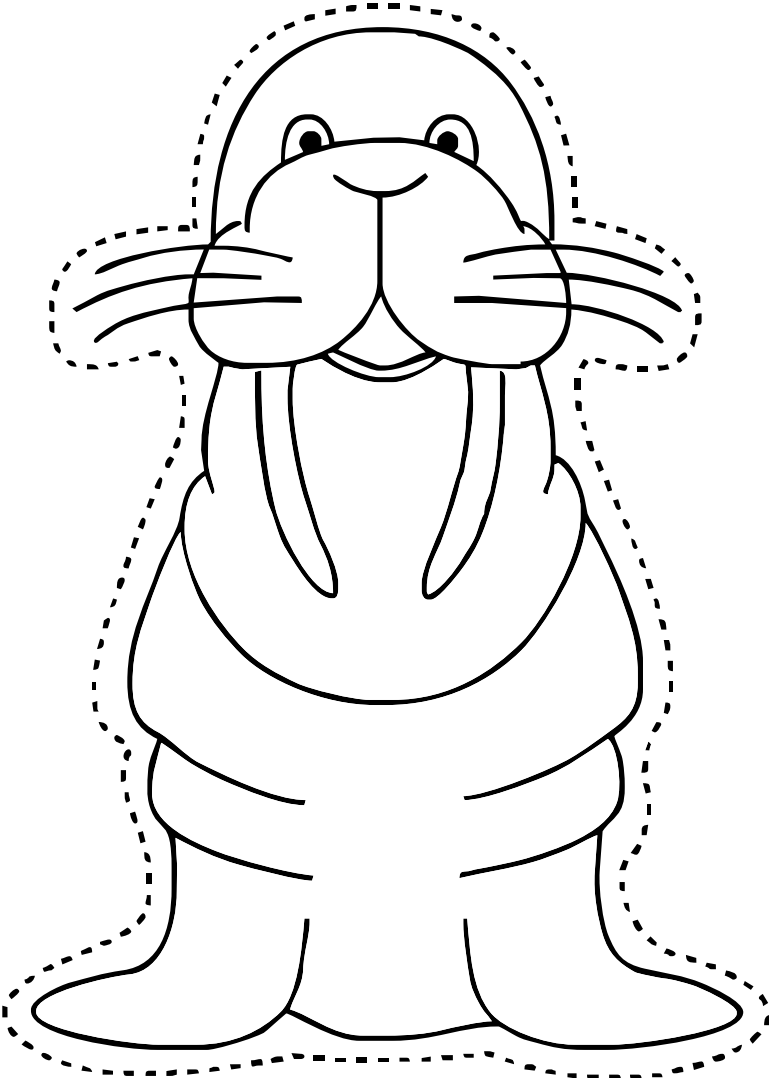

PUPPETS

ALIEN PUPPETS

MATERIALS

- cardboard (folder, cereal box)
- pencil or craft stick
- colors, markers, crayons
- scissors
- glue or tape
- patterns (p. 196)

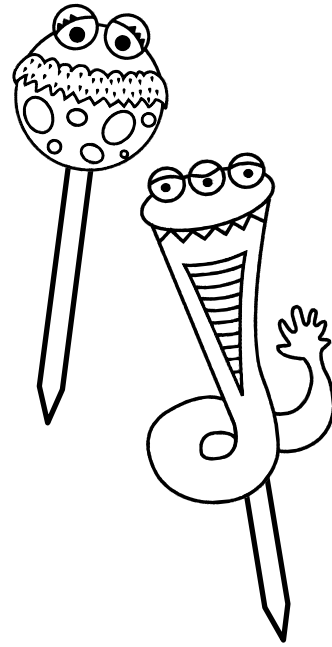

INSTRUCTIONS

1. Glue the patterns onto the cardboard.
2. Color and decorate.
3. Cut out along the solid line and glue or tape to the top of a pencil or craft stick.

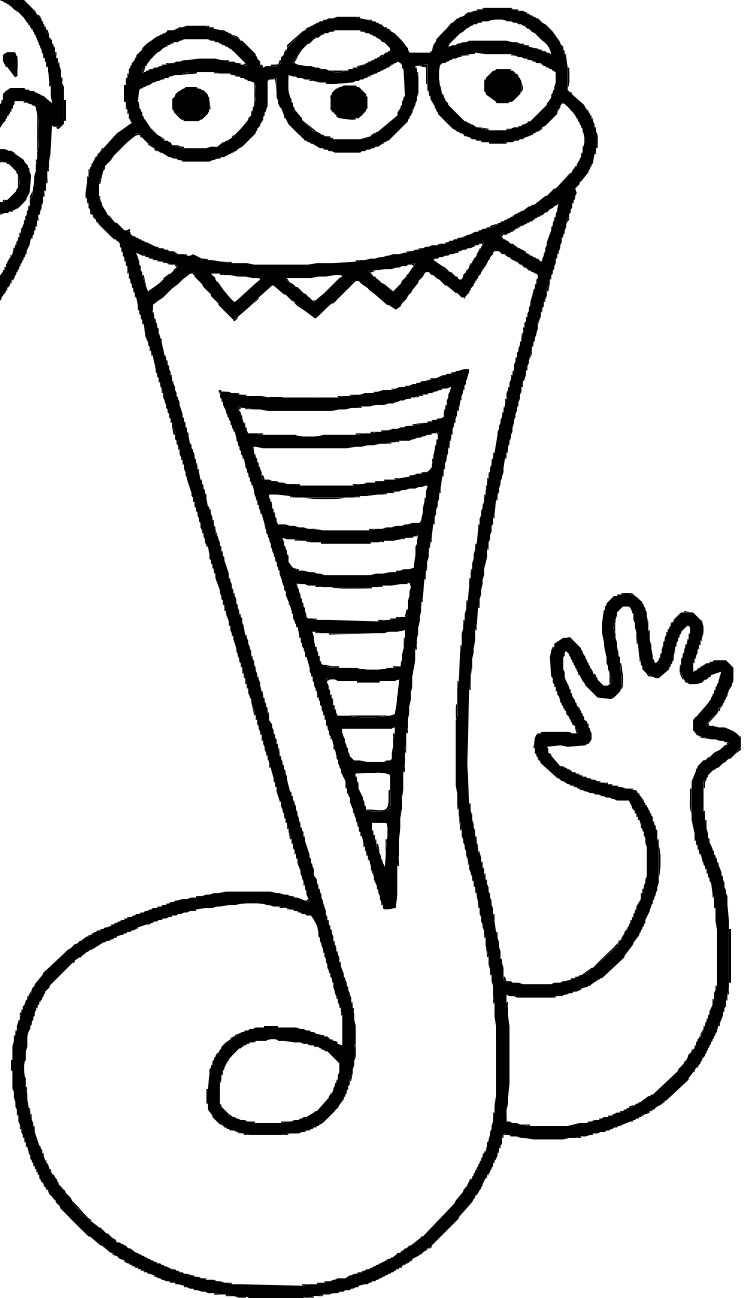
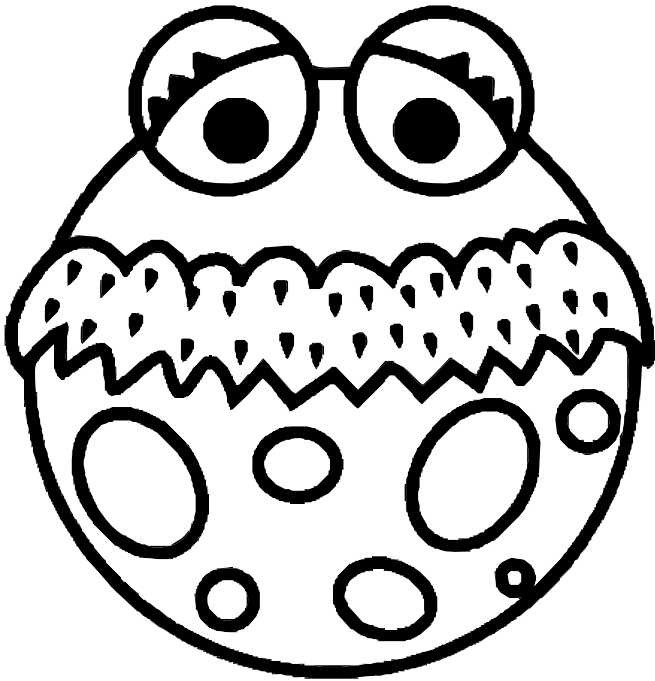

CHINESE DRAGON PUPPET

MATERIALS

- white paper plates
- craft sticks
- markers
- glue
- hole punch
- paper brads

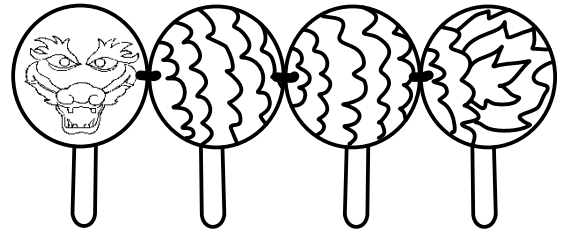

INSTRUCTIONS

1. Cut the circle shape out of the paper plate centers. Cut as many as you need for the desired length of your puppet.
2. Use the markers and draw a dragon face on the first circle. Draw scales, wings, or fire designs on the remaining circles.
3. Glue a craft stick to each circle. Let dry. (see fig. 1)
4. Punch a hole on each side of every circle, except the head and tail circles. Stick the brads through the holes to attach one circle to the next. (see fig. 2)

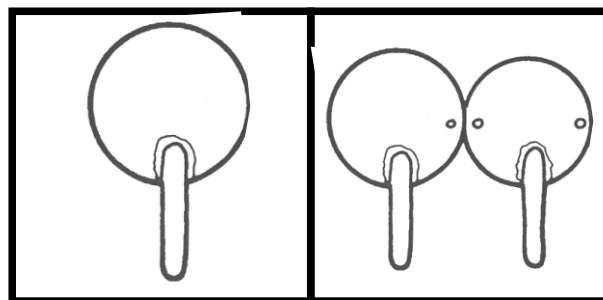

FIGURE 1

FIGURE 2

CLOTHESPIN PUPPETS

MATERIALS

- clothespins
- yarn
- scissors
- markers, paint
- scrap materials (felt, cloth fabric, rickrack)
- cardboard (folder, cereal box)
- glue
- face pattern (p. 199)

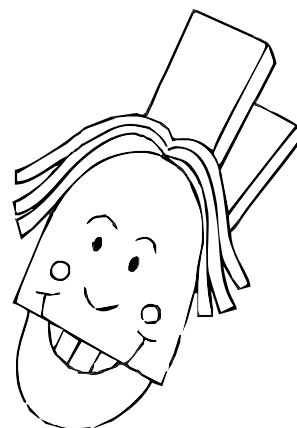

INSTRUCTIONS

1. Draw or paint a face on a round clothespin.
2. Use scrap material to make clothes and hair.
3. Glue the face pattern onto the cardboard, color and decorate.
4. Cut out the face along the solid line and cut in two at the mouth level. (see fig. 1)
5. Glue the top of the head to the top side of the clothespin. (see fig. 2)
6. Open the clothespin and glue the bottom of the mouth to the inner side of the clothespin. (see fig. 2)
7. Open and close the clothespin clasp to make the puppet's mouth move.

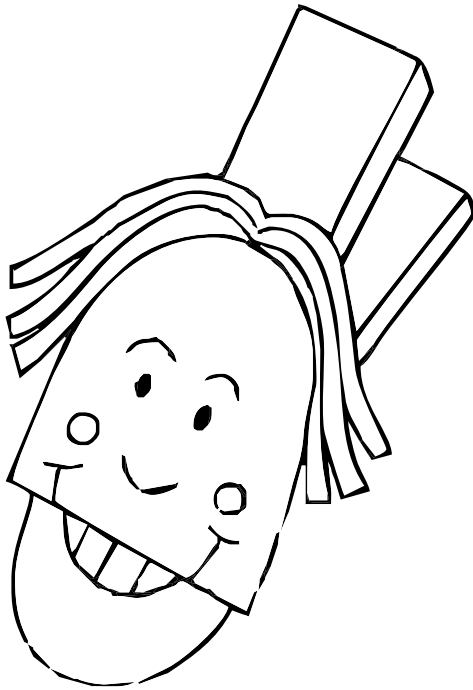

FIGURE 1

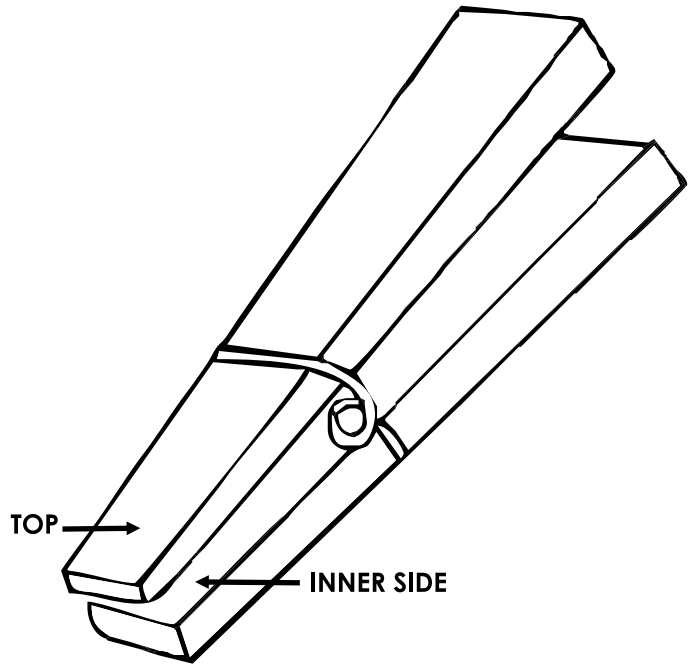
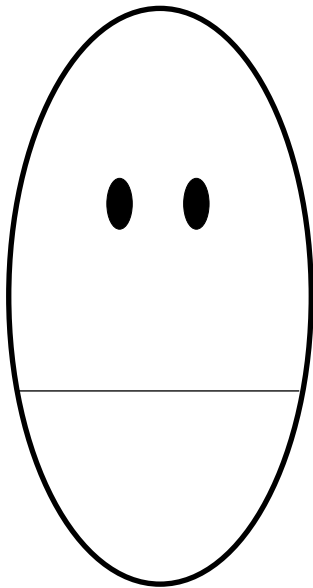

FIGURE 2



PATTERN

EGG CARTON CHARACTERS

MATERIALS

- egg carton
- rickrack (scraps of fabric, buttons, pipe cleaners, glitter, sequins, yarn, etc.)
- scissors
- markers
- glue / tape / stapler

INSTRUCTIONS

1. Cut the individual egg carton cups.
2. Use markers to draw facial features, and "dress" up with rickrack.



ELEPHANT PUPPET

MATERIALS

- colors, markers, crayons
- glue
- cardboard (folder, cereal box)
- scissors
- elephant pattern (p. 202)

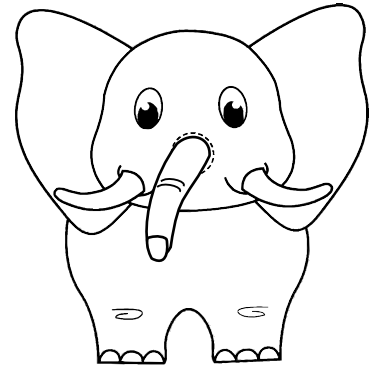

INSTRUCTIONS

1. Color and decorate the elephant pattern.
2. Glue onto the cardboard and cut out along the solid line.
3. Cut out the dotted circle.
4. Put your index finger through the hole and move it like an elephant's trunk!

ELEPHANT PUPPET PATTERN

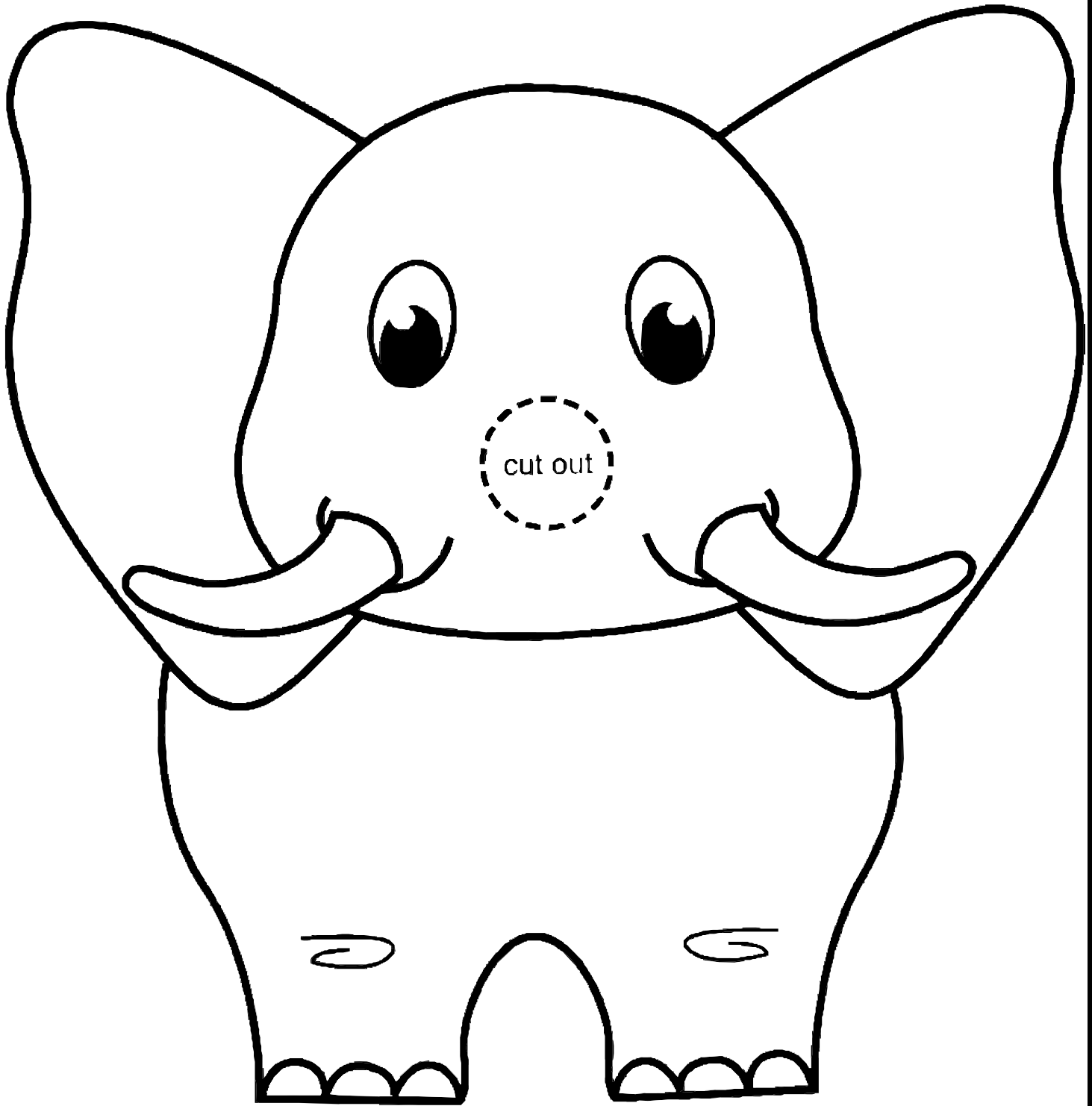

FINGER PUPPETS

MATERIALS

- clay
- wiggly eyes
- elbow pasta
- glue
- yarn
- wax paper

INSTRUCTIONS

1. Mold clay into a ball around the tip of your finger.
2. Push in wiggly eyes and elbow pasta for ears. (see fig. 1)
3. Remove the clay head carefully from your finger and place it on a sheet of wax paper to dry.
4. Glue on yarn for hair and any loose pieces. (see fig. 2)

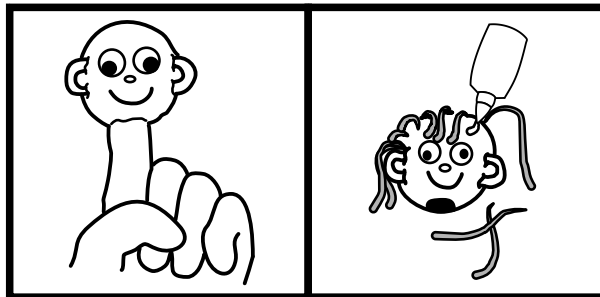

FIGURE 1

FIGURE 2

MARIONETTE

MATERIALS

- colors, markers, crayons
- cardboard (folder, cereal box)
- hole punch
- paper clips
- string or yarn
- long craft stick

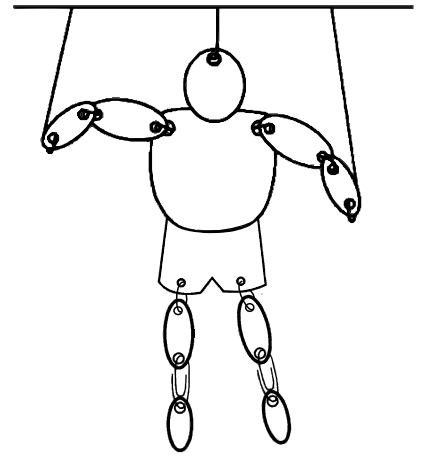

INSTRUCTIONS

1. Glue the pattern (p. 205) onto the cardboard and color.
2. Cut out each piece along the solid line and punch holes at the hole marks.
3. Link parts together with paper clips. (see fig. 1)
4. Tie yarn or string through the holes in hands and head; attach the other ends to the craft stick. (see fig. 2)
5. Pull and move strings to make the marionette dance.



FIGURE 1

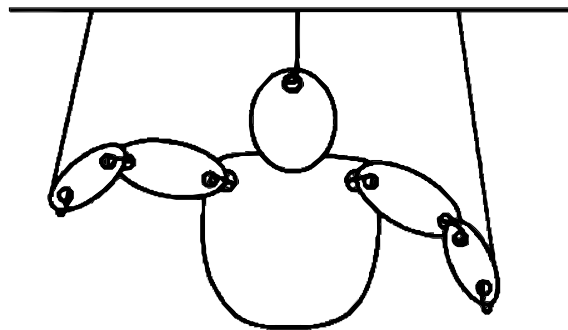
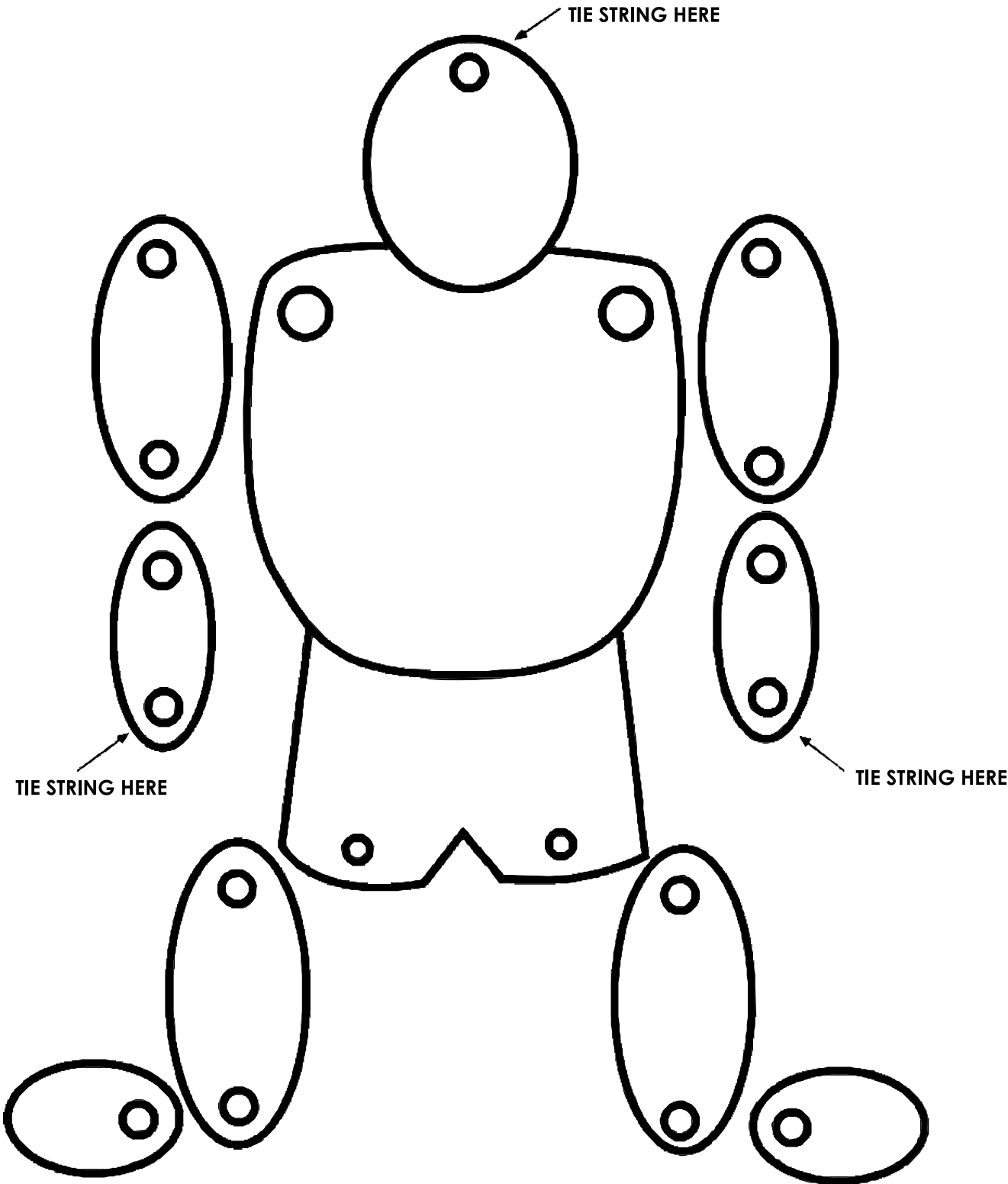

FIGURE 2

MARIONETTE PATTERN



PEANUT PUPPETS

MATERIALS

- peanuts in the shell
- wiggly eyes
- glue
- yarn
- marker

INSTRUCTIONS

1. Break off the bottom of a peanut shell and remove the peanuts. (see fig. 1)
2. Enlarge the hole in the peanut until you are able to insert a finger. (see fig. 2)
3. Using the markers, draw a face on the top part of the shell.
4. Glue on wiggly eyes and yarn hair. (see fig. 3)

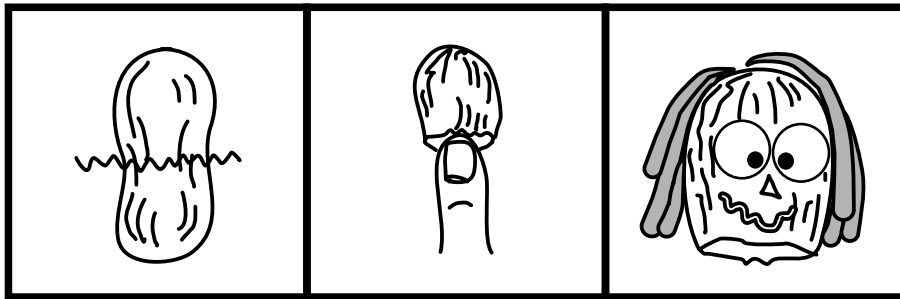

FIGURE 1

FIGURE 2

FIGURE 3

PIE PLATE FISH

MATERIALS

- 2 paper or aluminum medium sized pie plates
- cardboard (folder, cereal box)
- scissors
- stapler
- glue gun
- paint
- paintbrush
- newspaper (to cover work area)
- craft stick or tongue depressor
- fish patterns (p. 208)



INSTRUCTIONS

1. Place the two pie plates together (bottoms out) and staple around the edges.
2. Glue the fish patterns onto the cardboard.
3. Cut out the patterns along the solid line and use them as templates to draw another set of patterns on another piece of cardboard; also cut them out.
4. Staple both head, fins and tail pieces together, leaving one side open to attach to the pie plates.
5. Staple or glue the craft stick onto the fish.
6. Color the fish with paints and decorate with glitter, sequins, buttons, beads, etc.

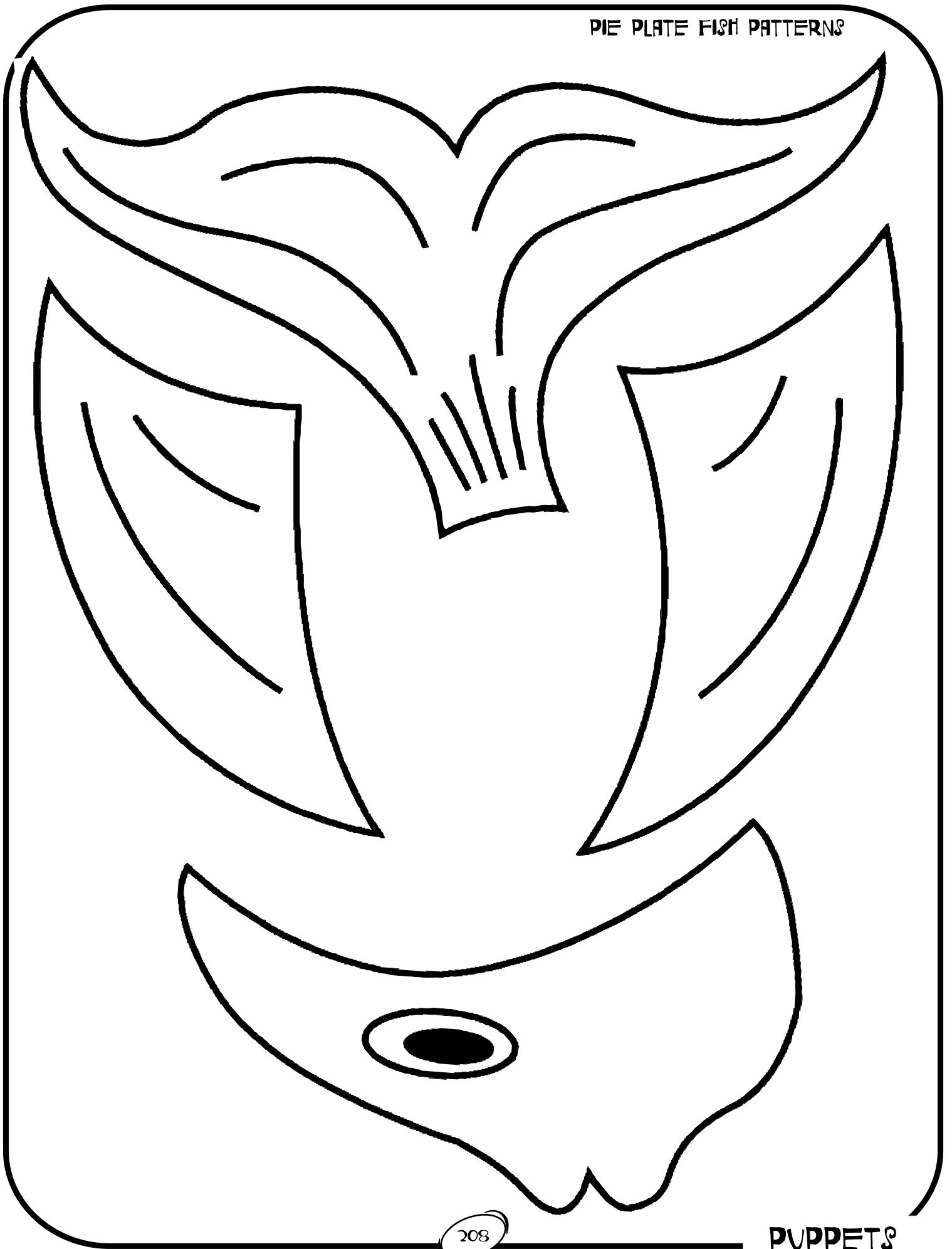

PUPPET GLOVE

MATERIALS

- pattern
- old glove
- felt
- wiggly eyes
- yarn
- pipe cleaners
- glue
- scissors

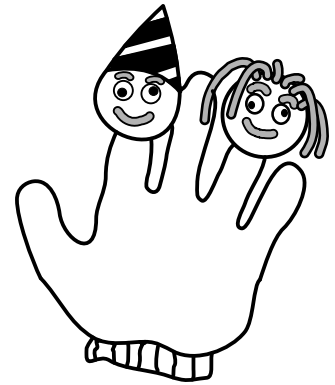

INSTRUCTIONS

1. Trace pattern 5 times onto the felt and cut out.
 2. Glue on wiggly eyes, yarn, and pipe cleaner pieces to create faces and hair. (see fig. 1)
 3. Glue one face to each finger of the glove. (see fig. 2)
- * Instead of gluing the faces to the glove fingers, attach them with velcro, so you can add and remove as many faces as you like. *

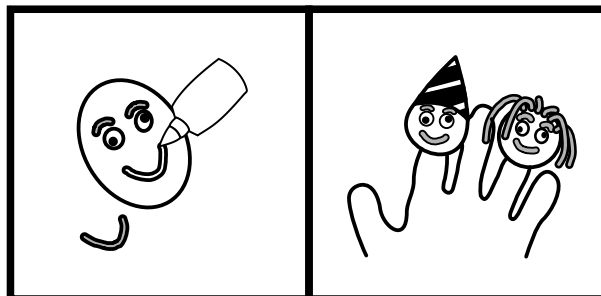
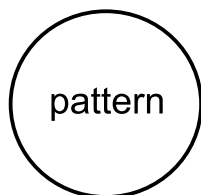

FIGURE 1

FIGURE 2

SHADOW PUPPETS

MATERIALS

- puppet patterns (pp. 211-213)
- cardboard (folder or cereal box)
- scissors
- glue
- craft sticks
- brads (for skeleton, boy and girl puppets only)

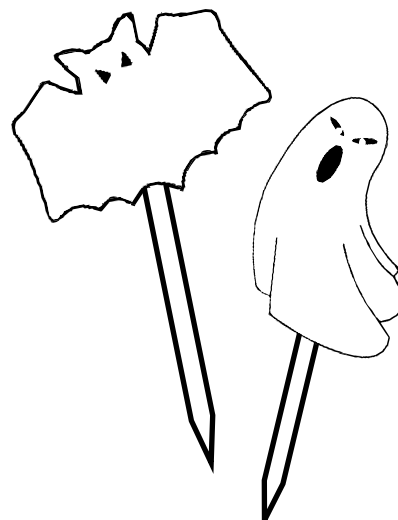

INSTRUCTIONS

1. Glue the puppet patterns onto the cardboard and cut out along the solid lines.
2. Cut out any black areas inside the puppet (eyes, noses, mouths, etc.).
3. Glue a craft stick on the back of the puppet.

* SKELETON, BOY AND GIRL PUPPETS:

1. Glue the puppet patterns onto the cardboard and cut out along the solid lines.
2. Cut out any black areas inside the puppet (eyes, noses, mouths, etc.). Do not cut out the brad marks.
3. Attach the pieces together with brads to look like given examples.
4. Glue craft sticks on the back of the puppet; one at the bottom and as many as you need on the movable parts.

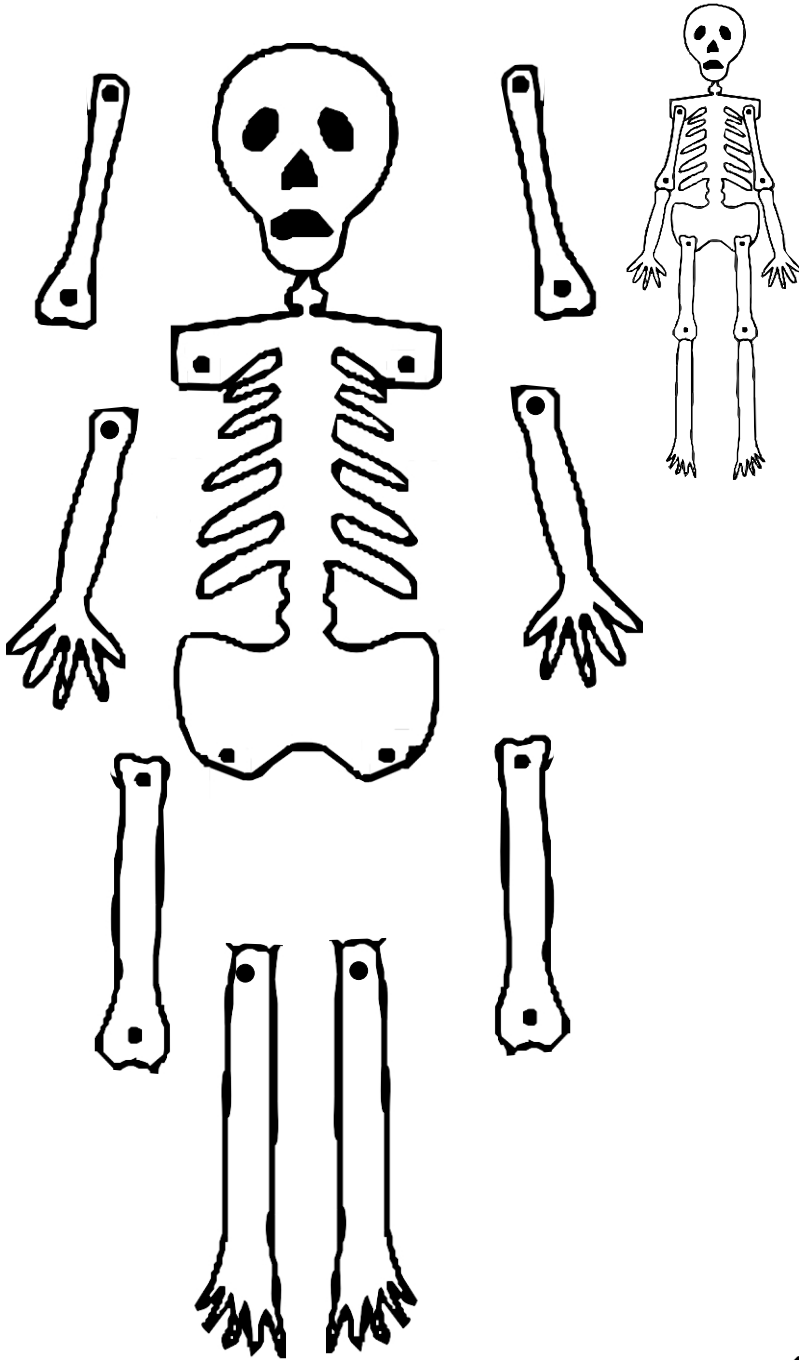

SKELETON PATTERNS



BAT PATTERN



CROW PATTERN

SHADOW PUPPETS PATTERNS

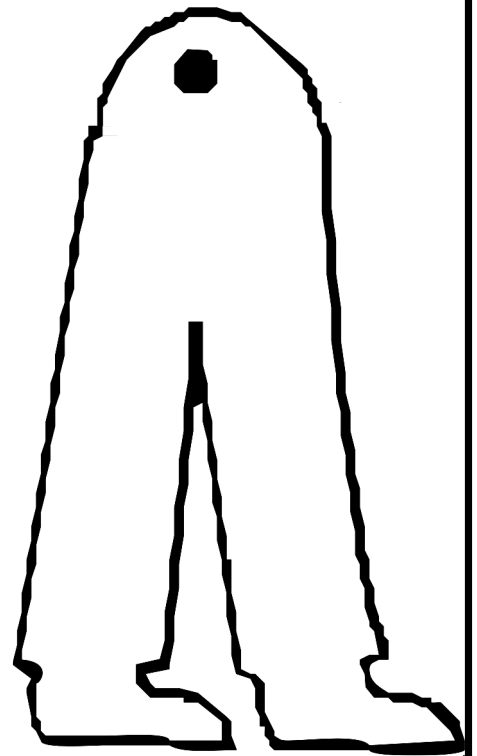
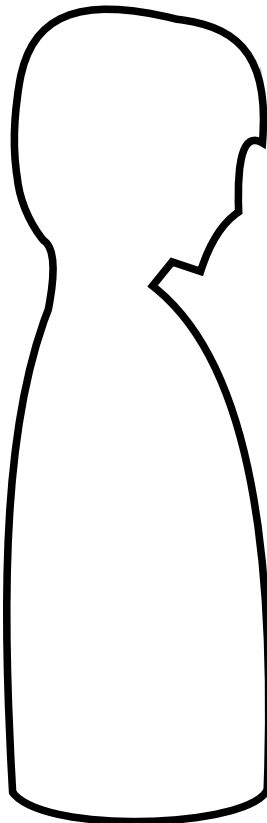
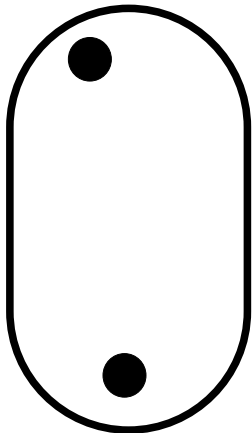
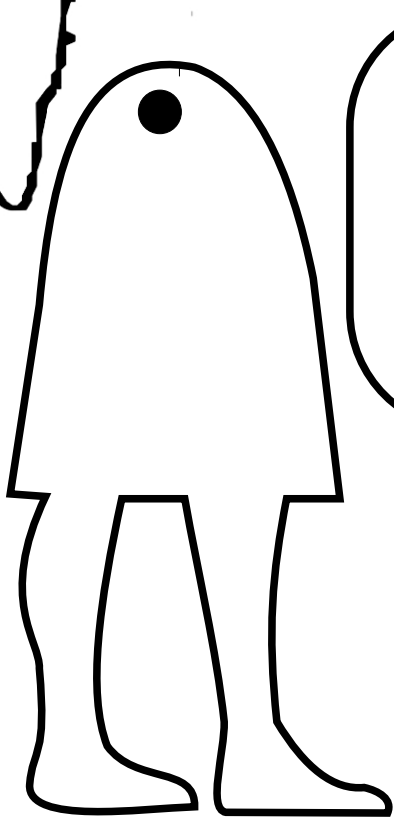
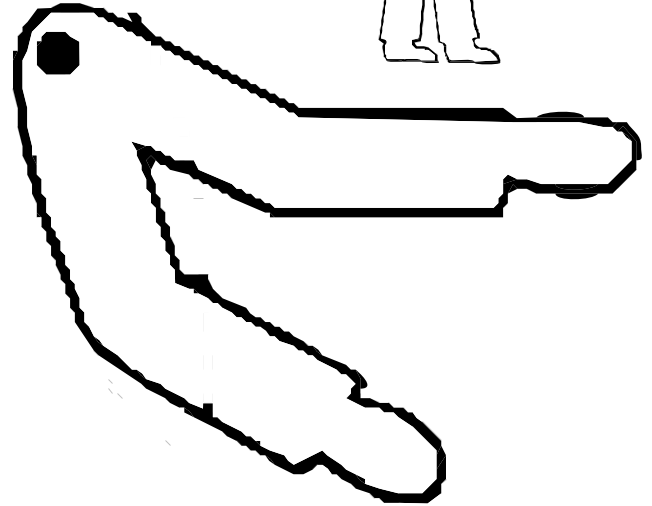
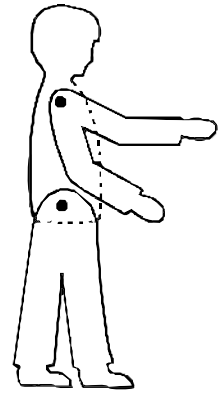
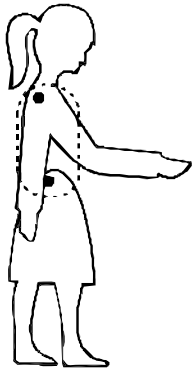
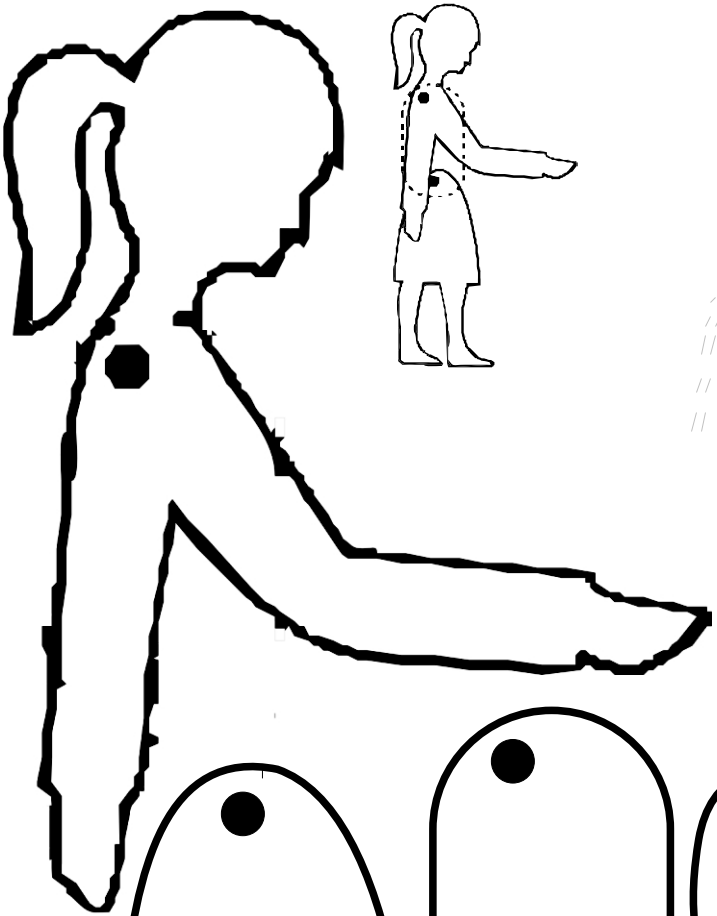

GIRL PATTERNS

BOY PATTERNS

SHADOW PUPPETS PATTERNS

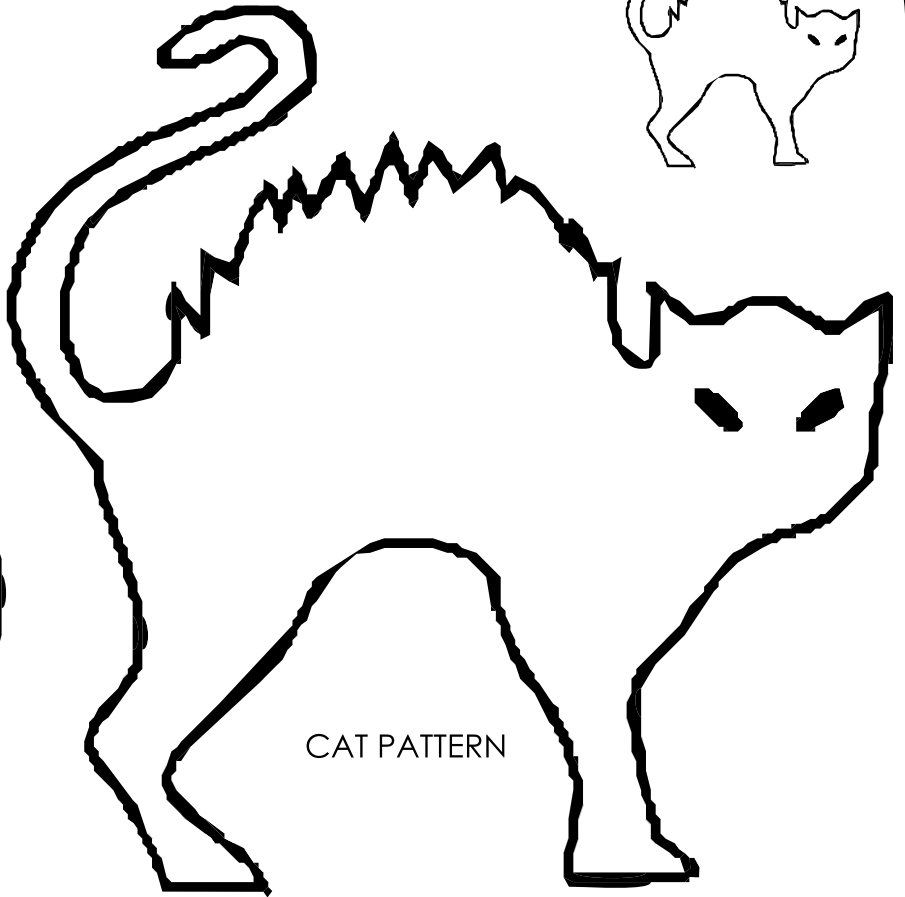
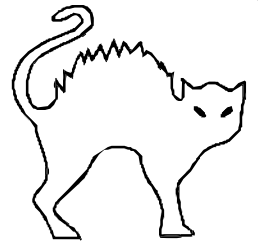

CAT PATTERN

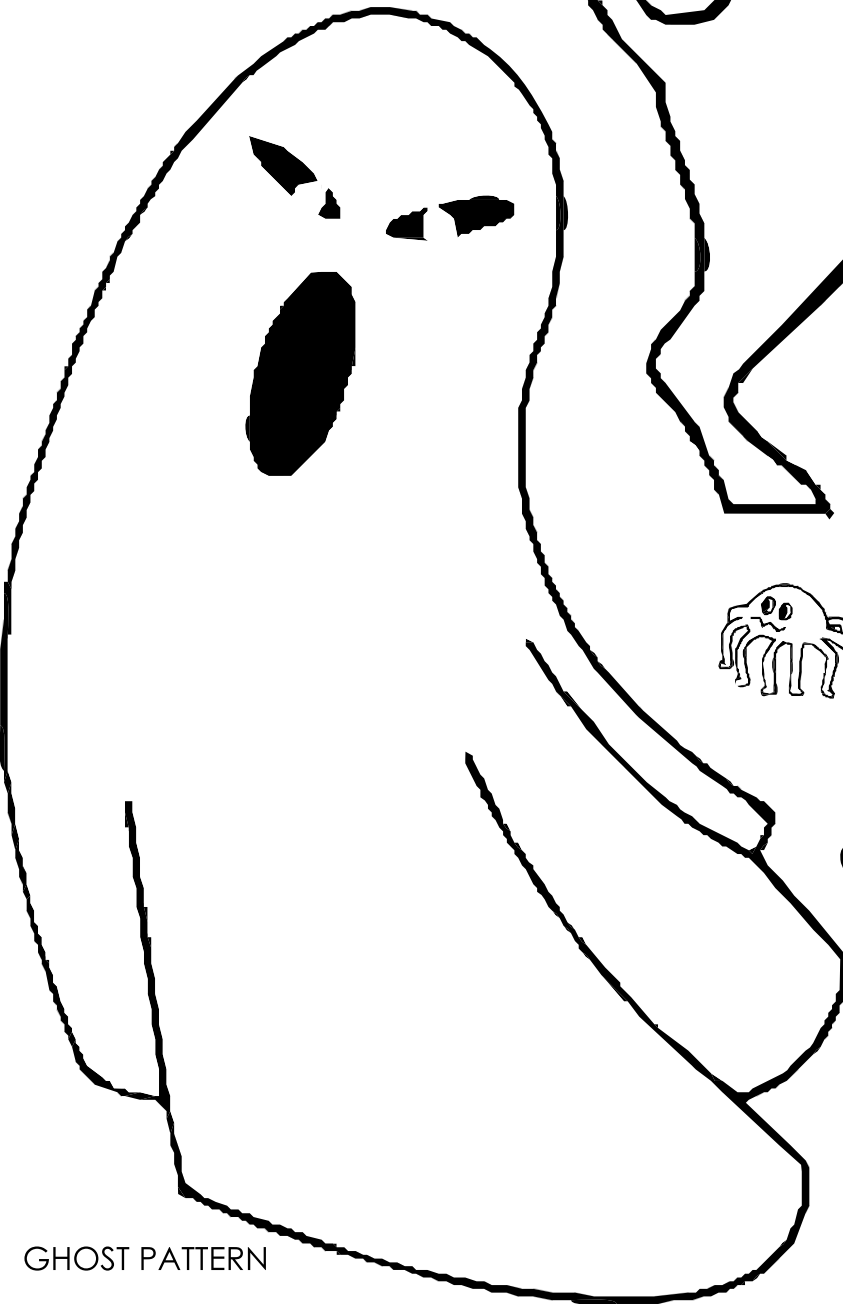

GHOST PATTERN



SPIDER PATTERN

SILLY SPOON PUPPETS

MATERIALS

- 1 wooden spoon
- 20 cms. x 50 cms. piece of cloth fabric
- 1 rubber band
- felt scraps
- buttons
- glue or tape
- yarn or feathers
- scissors
- cardboard (folder, cereal box)
- old photographs



INSTRUCTIONS

1. Cut out the faces of old photos or draw faces on cardboard pieces and glue onto the spoon.
2. Gather the cloth fabric rectangle around the base of the spoon to create a collar and a skirt. (see example)
3. Hold in place with the rubber band.
4. Use a strip of felt to cover the rubber band and glue into place.
5. Use yarn or feathers to make hair and glue into place.
6. Use assorted materials to create eyelashes, bows, funny noses, big mouths, etc., and glue onto the puppet.
7. Use buttons and felt or cloth fabric scraps to decorate clothes. (see example)

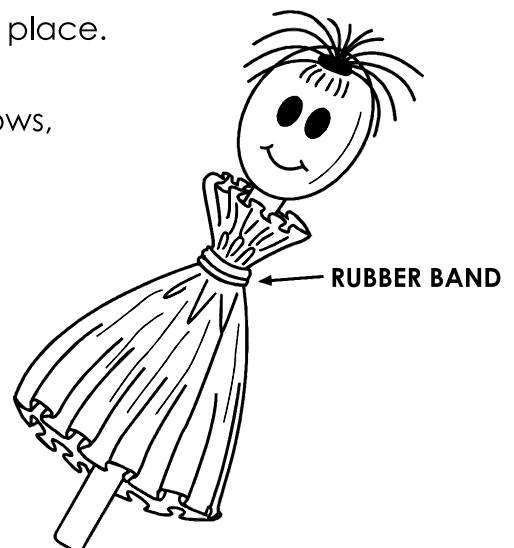

STAGE NECKLACE

MATERIALS

- letter sized folder
- scissors
- ruler
- hole punch
- crayons or markers
- yarn

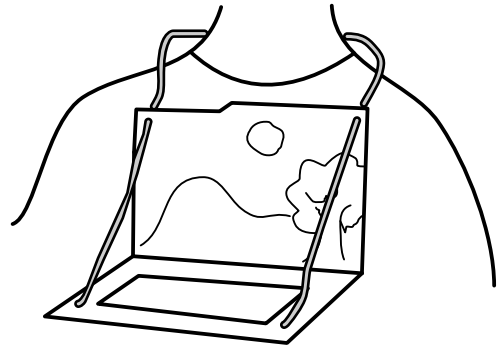

INSTRUCTIONS

1. Cut out the center of one of the sides of the folder, leaving a 2.5 cms. border to look like a frame. (see fig. 1)
2. On the side opposite of the frame, draw a scene. The bottom of the scene should end at the fold. This will be the background of the stage. (see fig. 2)
3. Punch holes on all four corners of the folder. Thread yarn through the holes, leaving enough to open the stage while it is suspended around your neck. Tie the yarn into a knot. (see fig. 3)

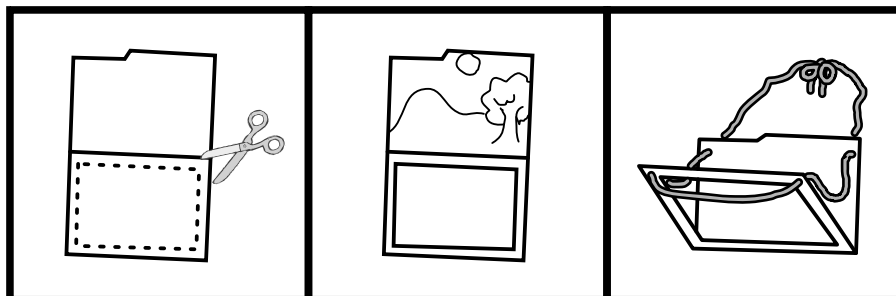

FIGURE 1

FIGURE 2

FIGURE 3

STICK PUPPETS

MATERIALS

- paper plates
- craft sticks or tongue depressors
- stapler
- crayons, colors, markers
- yarn
- scrap material (gift wrapping paper, felt, cloth fabric, buttons, ribbon, etc.)
- glue
- hot glue gun
- patterns (pp. 216, 217)

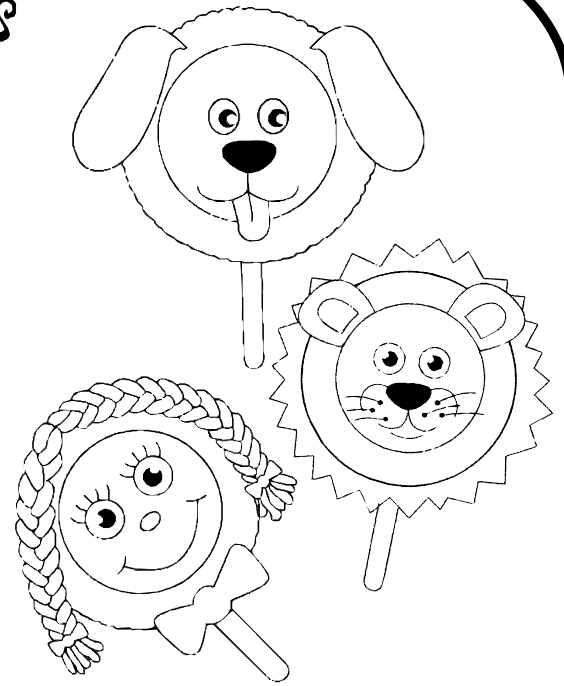

INSTRUCTIONS

1. Create different characters by drawing faces onto the plates.
2. Use scrap materials to make hair, ears, and other features and decorations. Glue or staple in place.
3. Use the hot glue gun to place the craft sticks onto the plates to make handles for the puppets.

GIRL'S BOW PATTERNS

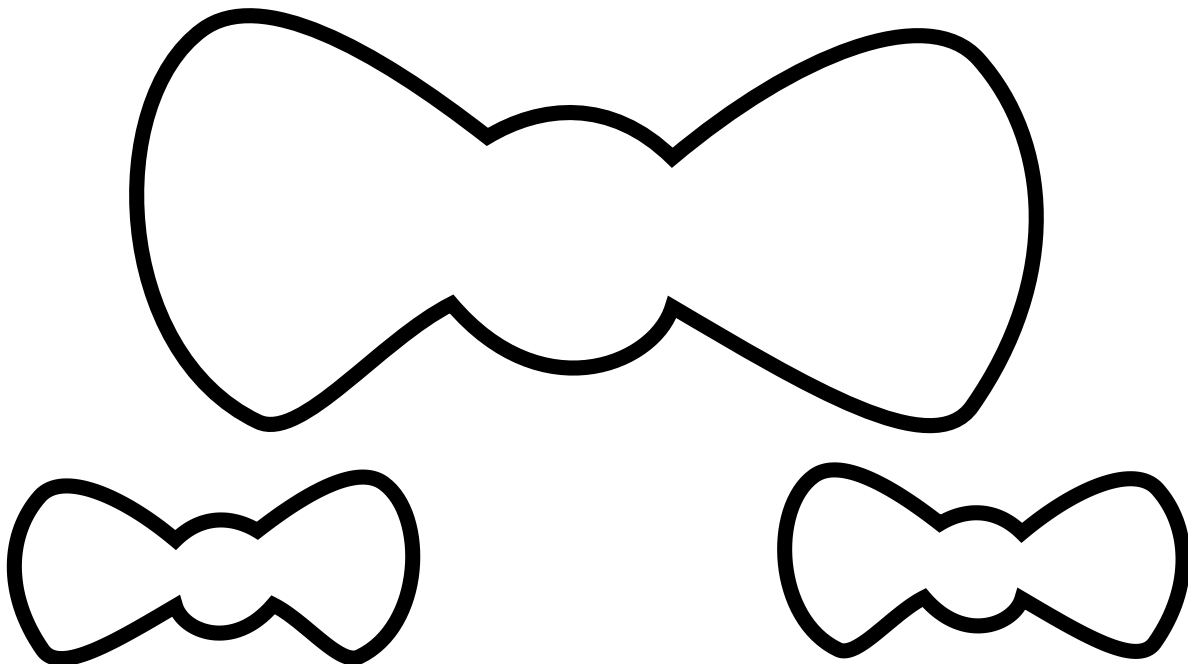

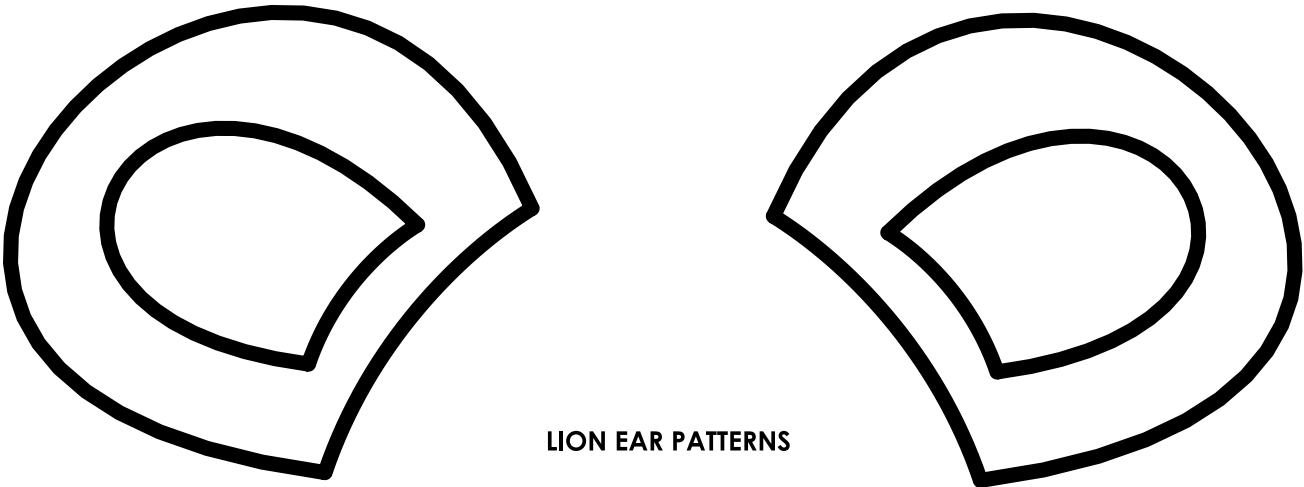

LION EAR PATTERNS

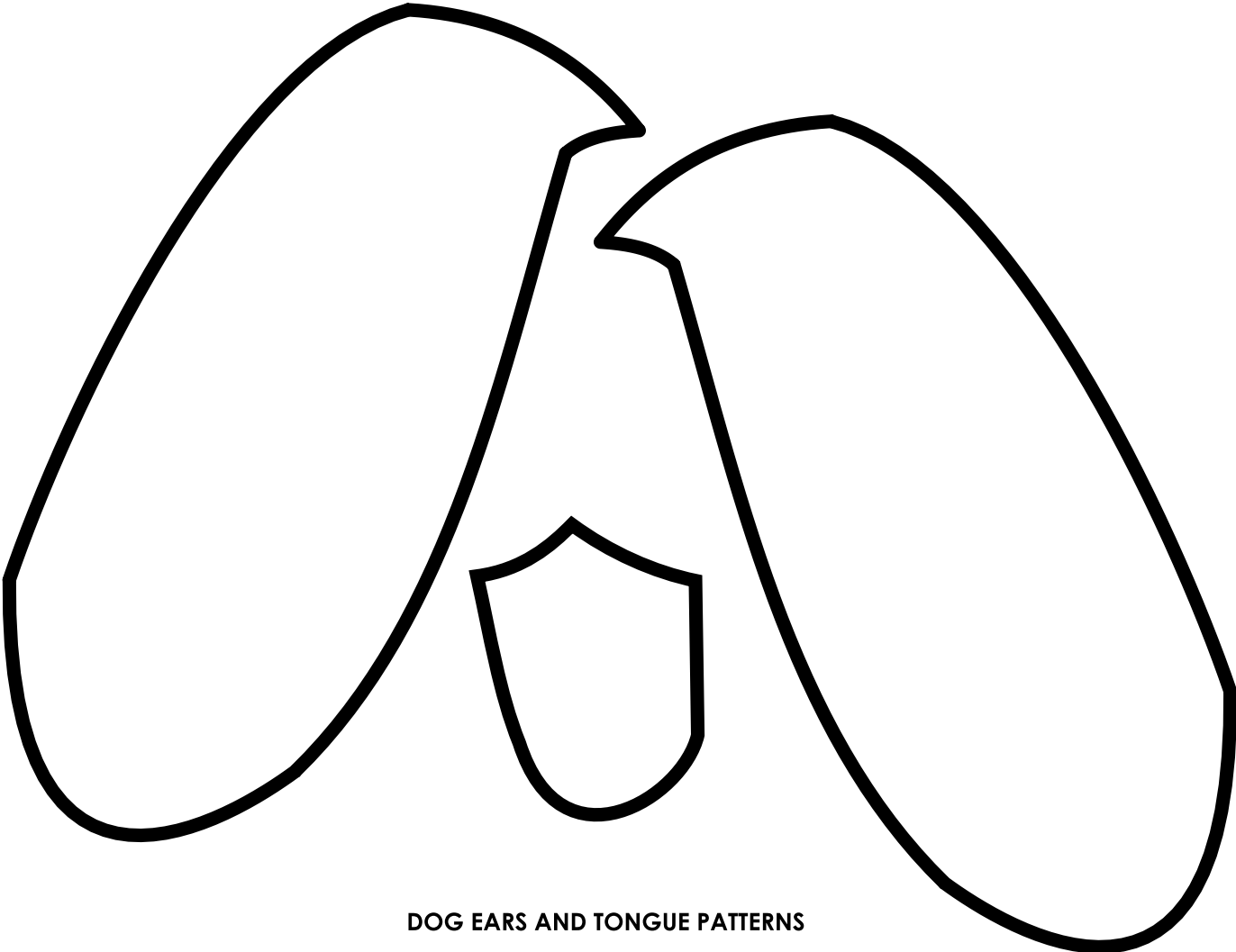

DOG EARS AND TONGUE PATTERNS

Use with p. 594

FOLDED PAPER PUPPETS

BASE PUPPET

MATERIALS

- letter sized construction paper

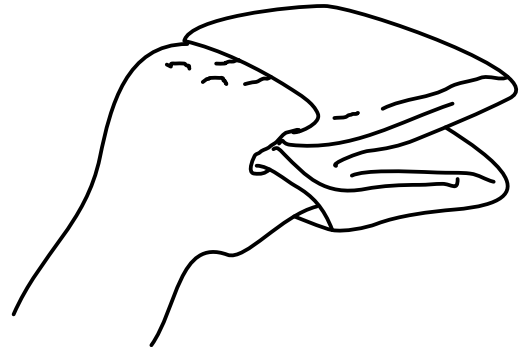

INSTRUCTIONS

1. Place the construction paper lengthwise. Fold in thirds, from top to bottom, and from bottom to top. (see fig. 1)
2. Fold in half, from left to right. (see fig. 2)
3. Fold top edge back in half. Turn over and repeat on the other side. (see figs. 3-4)
4. Glue the pattern pieces to the folded paper puppet.
5. Place fingers in open spaces to make puppet talk.

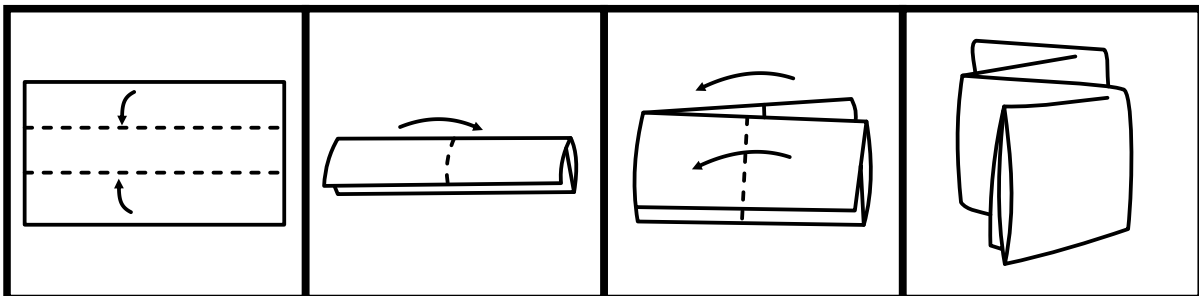

FIGURE 1

FIGURE 2

FIGURE 3

FIGURE 4

BILLY GOAT

MATERIALS

- letter sized white construction paper (for base puppet)
- patterns (p. 220)
- markers or crayons
- scissors
- glue

INSTRUCTIONS

1. Make the basic puppet from the construction paper.
2. Color the pattern pieces and cut out.
3. Glue the pattern pieces onto the basic puppet. (see example)
4. Add eyes with crayons or markers.

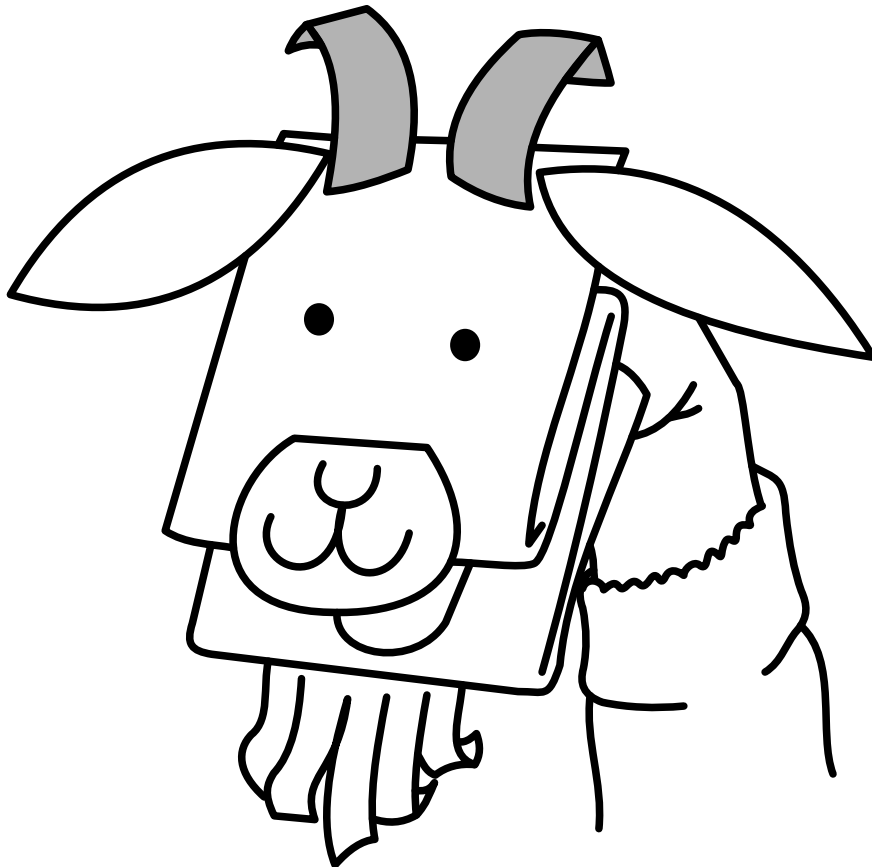

BILLY GOAT PUPPET PATTERNS

beard

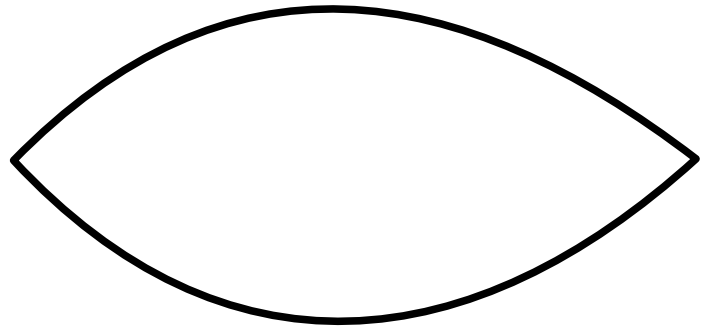
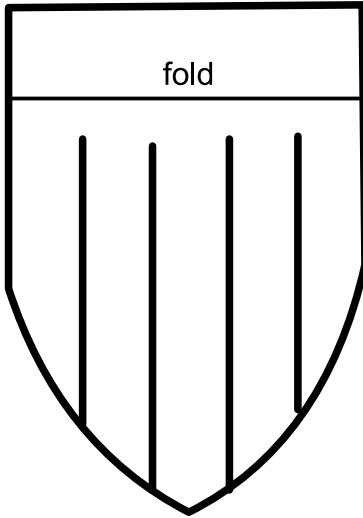

ears

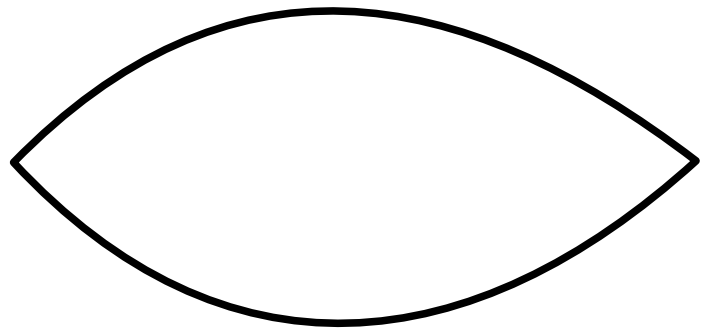

horns

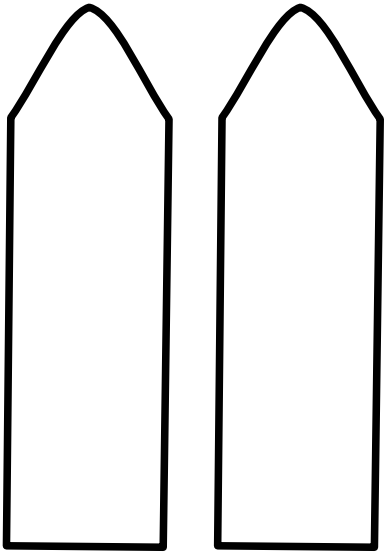

Curl horns over a pencil.

tongue

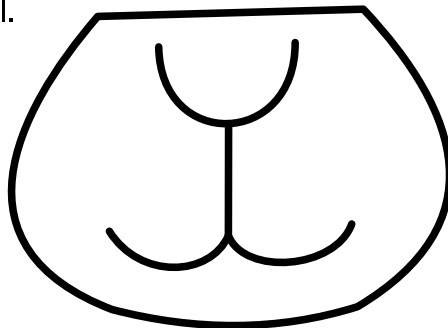

snout

BLUEBIRD

MATERIALS

- letter sized blue construction paper (for base puppet)
- patterns (p. 222)
- markers or crayons
- scissors
- glue

INSTRUCTIONS

1. Make the basic puppet from the construction paper.
2. Color the pattern pieces and cut out.
3. Glue the pattern pieces onto the basic puppet. (see example)

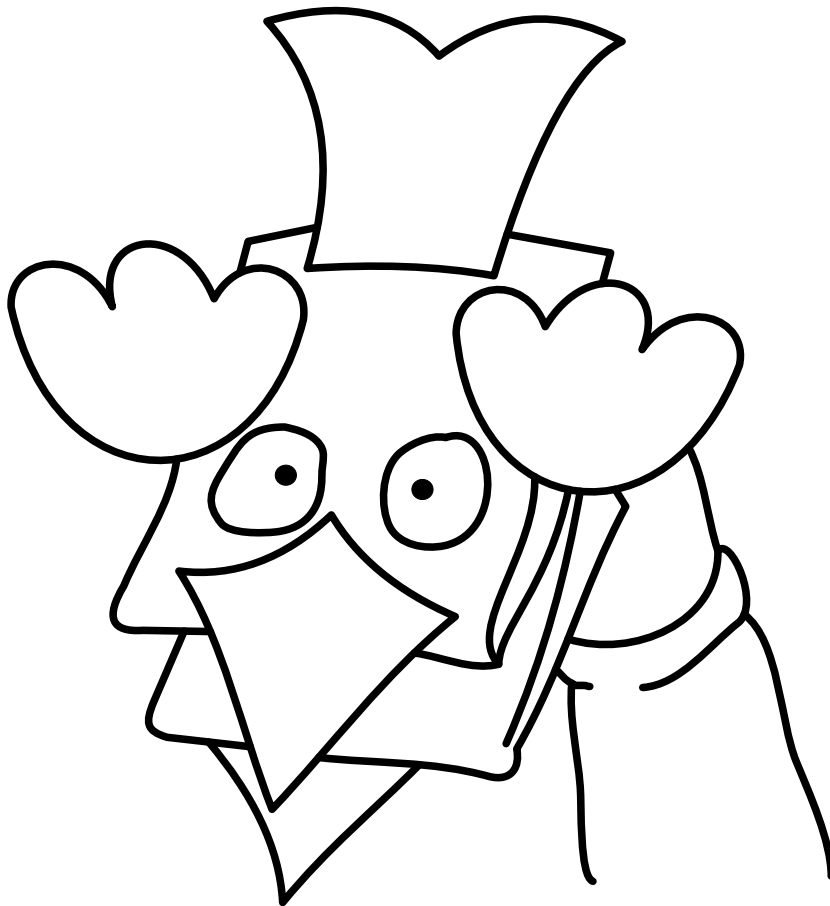

BLUEBIRD PUPPET PATTERNS

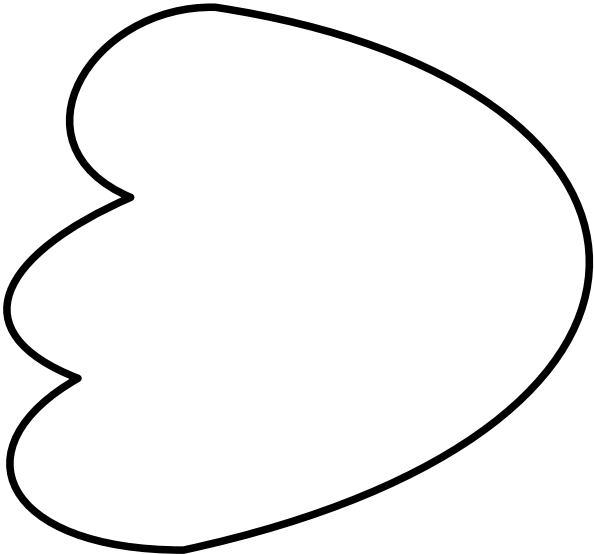

wings

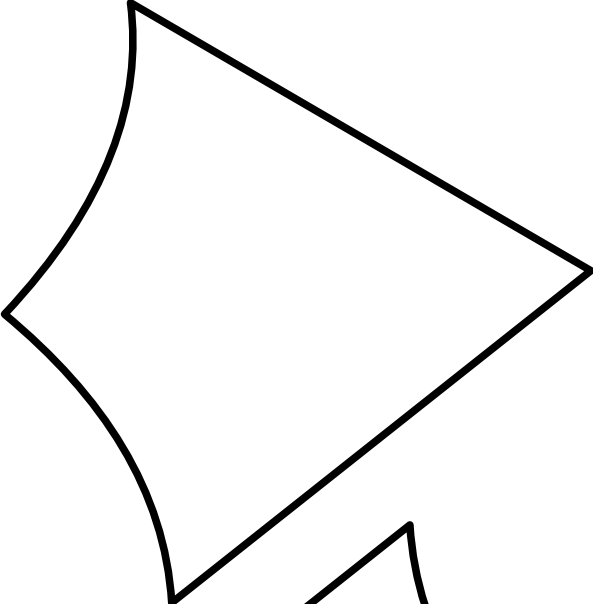

beak



tail

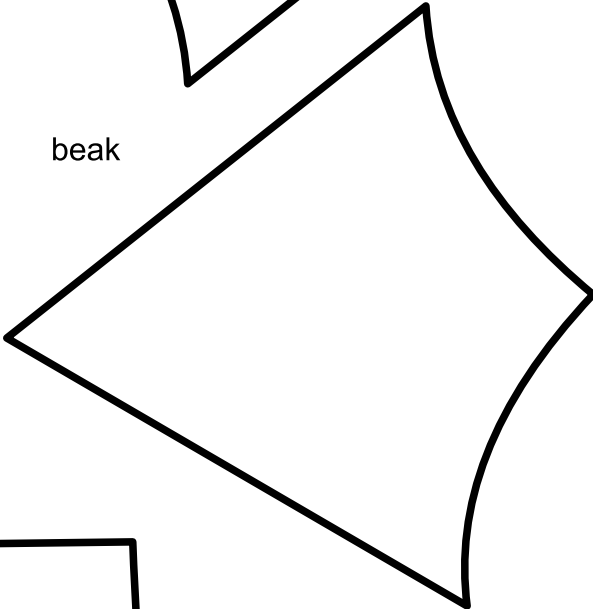

fold

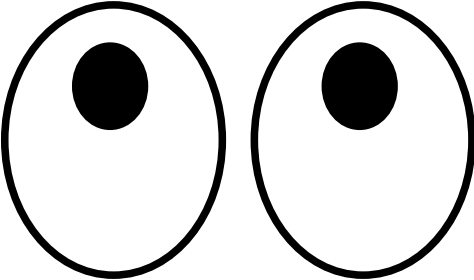

eyes

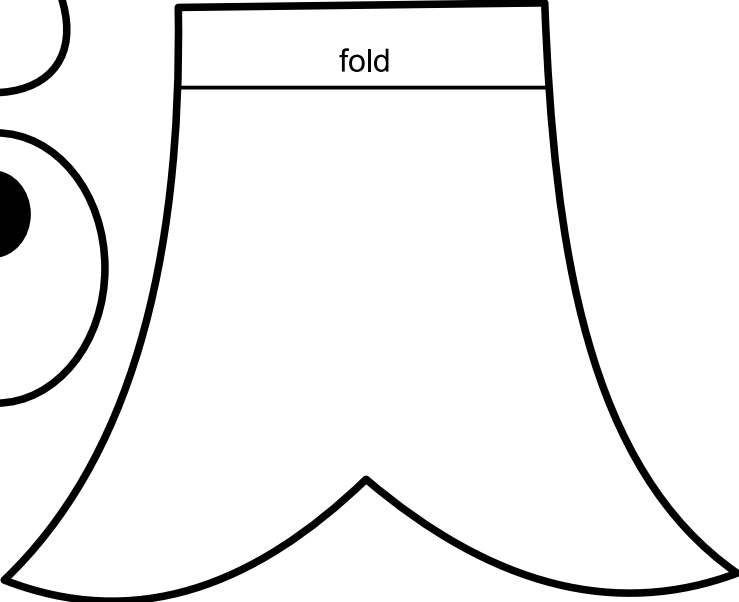

BUMBLEBEE

MATERIALS

- letter sized yellow construction paper (for base puppet)
- patterns (p. 224)
- markers or crayons
- scissors
- glue

INSTRUCTIONS

1. Make the basic puppet from the construction paper.
2. Color the pattern pieces and cut out.
3. Glue the pattern pieces onto the basic puppet. (see example)

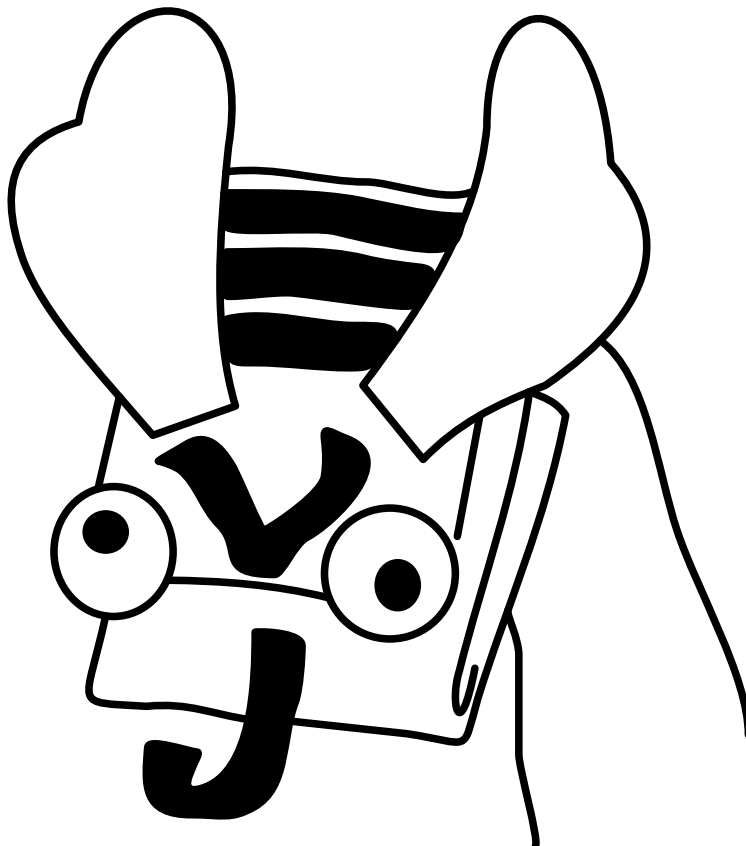

BUMBLEBEE PUPPET PATTERNS

black stripes

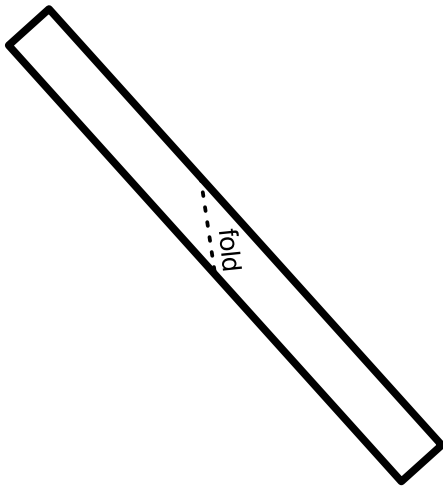

tongue

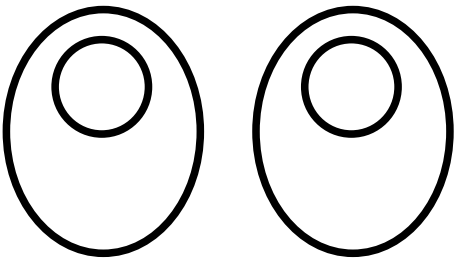

eyes

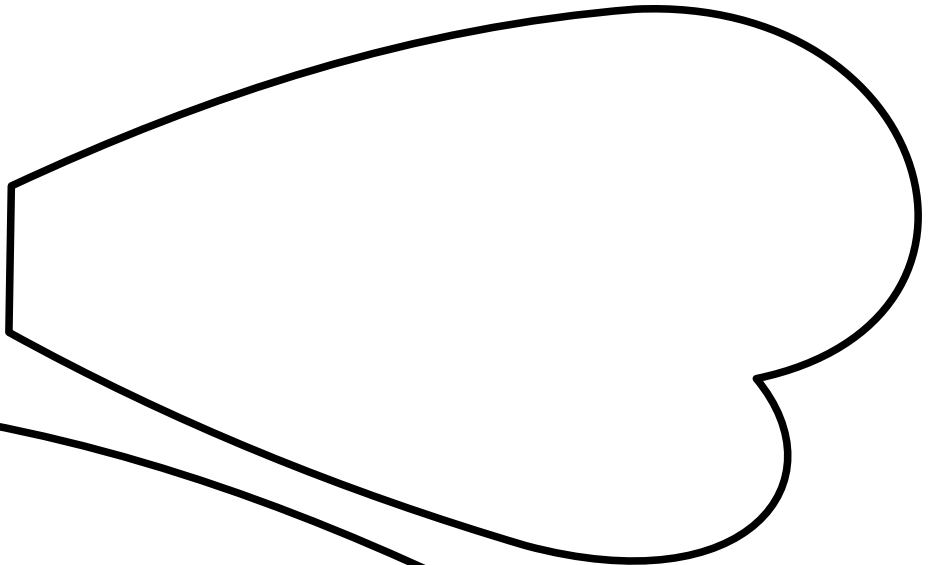

wings

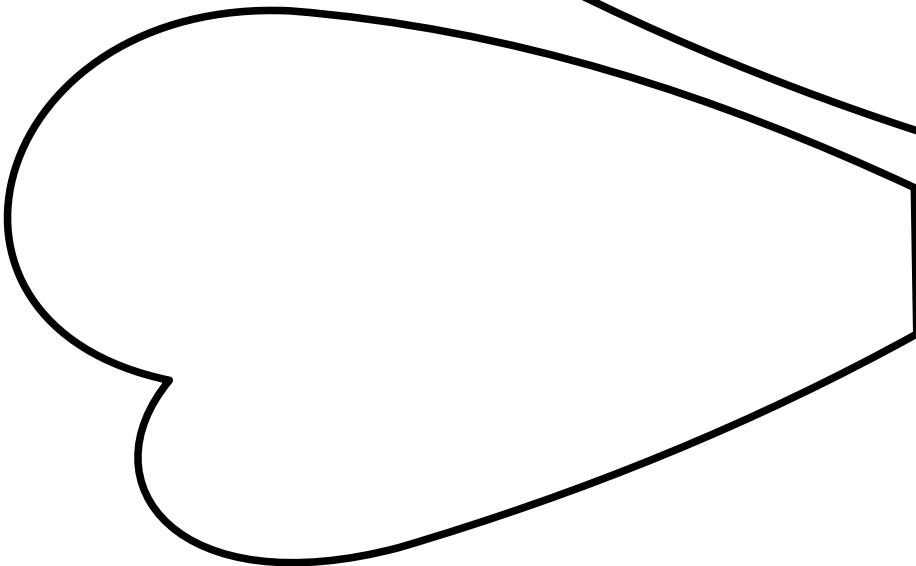

COW

MATERIALS

- letter sized brown construction paper (for base puppet)
- patterns (p. 226)
- markers or crayons
- scissors
- glue

INSTRUCTIONS

1. Make the basic puppet from the construction paper.
2. Color the pattern pieces and cut out.
3. Glue the pattern pieces onto the basic puppet. (see example)
4. Roll the nose section up.

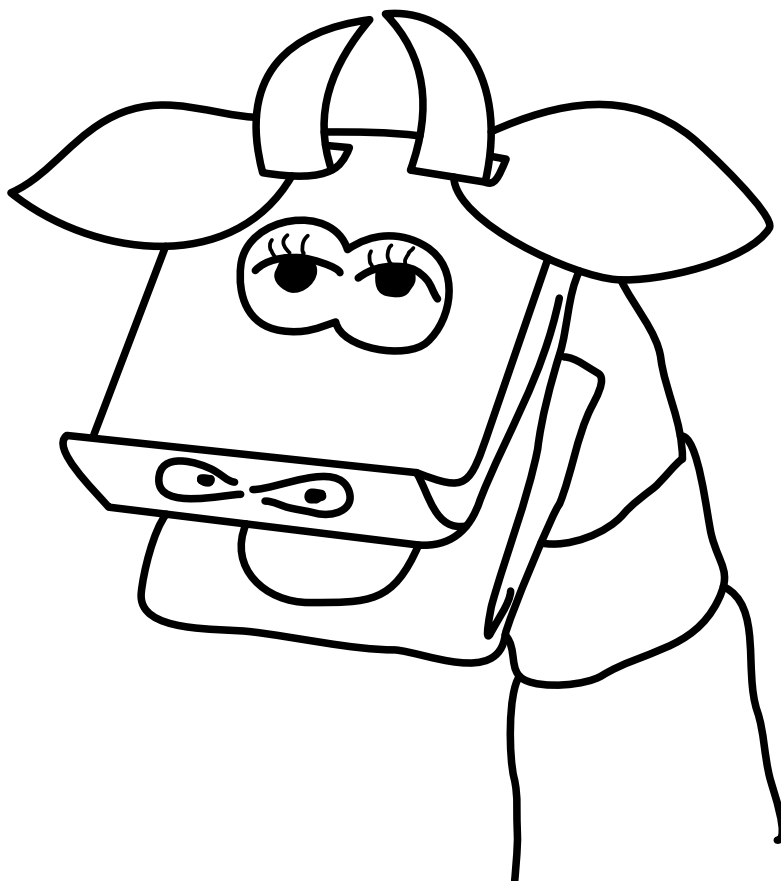

COW PUPPET PATTERNS

ears

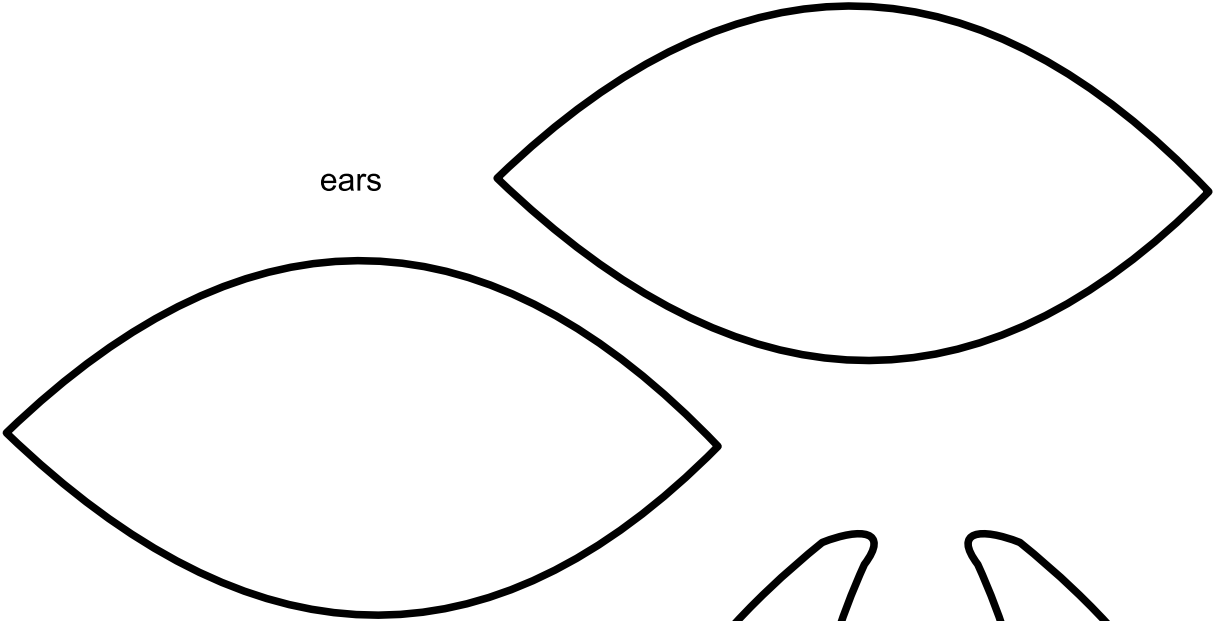

eyes

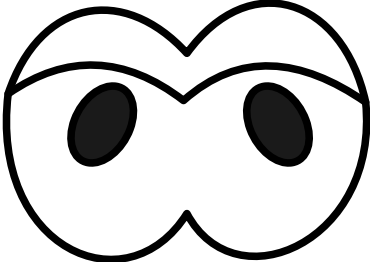

horns

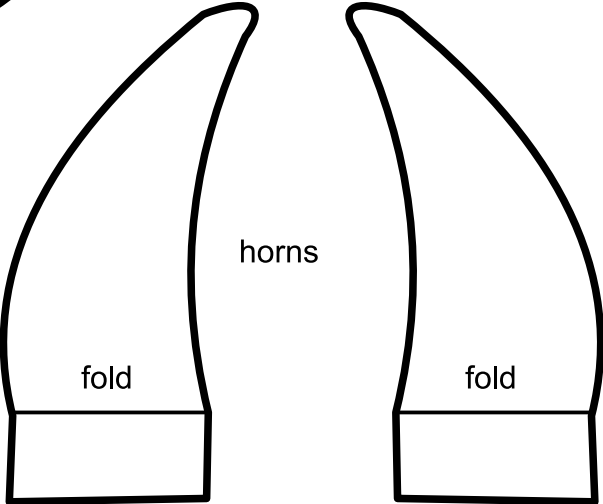

tongue



DRAGON

MATERIALS

- letter sized green construction paper (for base puppet)
- patterns (p. 228)
- markers or crayons
- scissors
- glue

INSTRUCTIONS

1. Make the basic puppet from the construction paper.
2. Color the pattern pieces and cut out.
3. Glue the pattern pieces onto the basic puppet. (see example)
4. Add eyebrows with crayons or markers.



DRAGON PUPPET PATTERNS

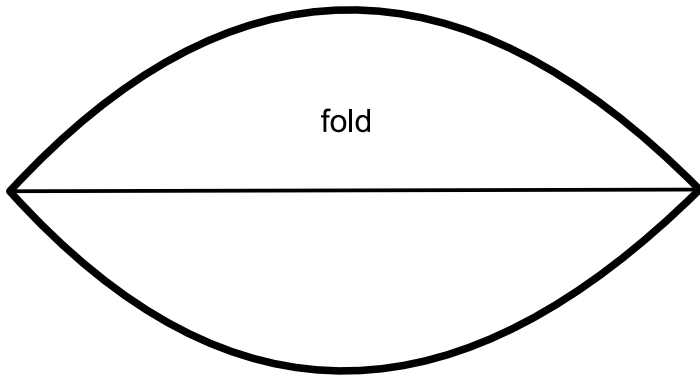

ears

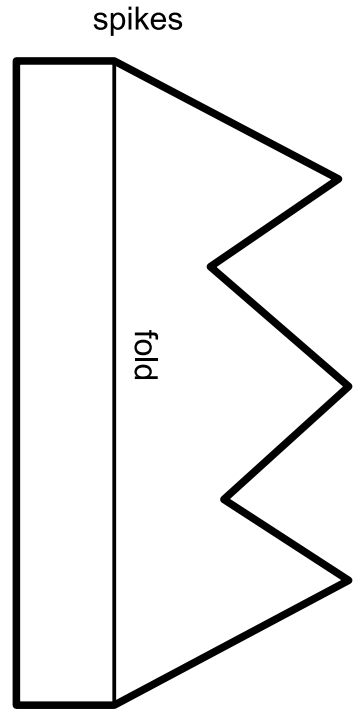
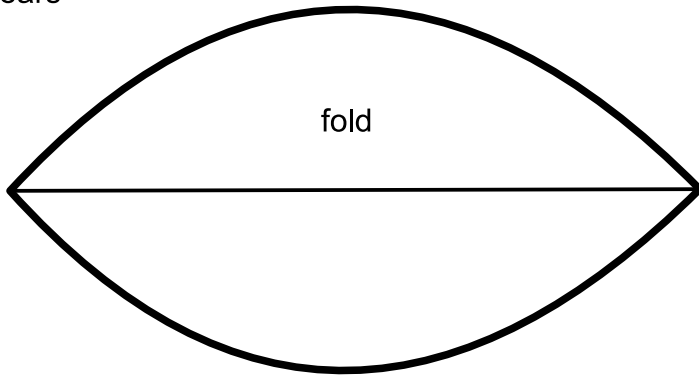

spikes

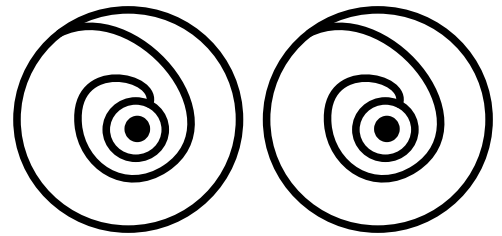

eyes

tongue

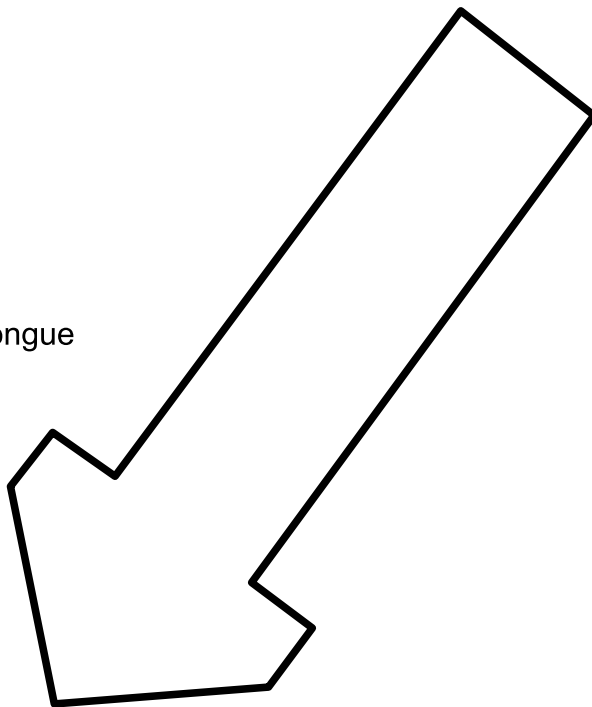

FROG

MATERIALS

- letter sized green construction paper (for base puppet)
- patterns (p. 230)
- markers or crayons
- scissors
- glue

INSTRUCTIONS

1. Make the basic puppet from the construction paper.
2. Color the pattern pieces and cut out.
3. Glue the pattern pieces onto the basic puppet. (see example)
4. Draw nostrils with crayons or markers.

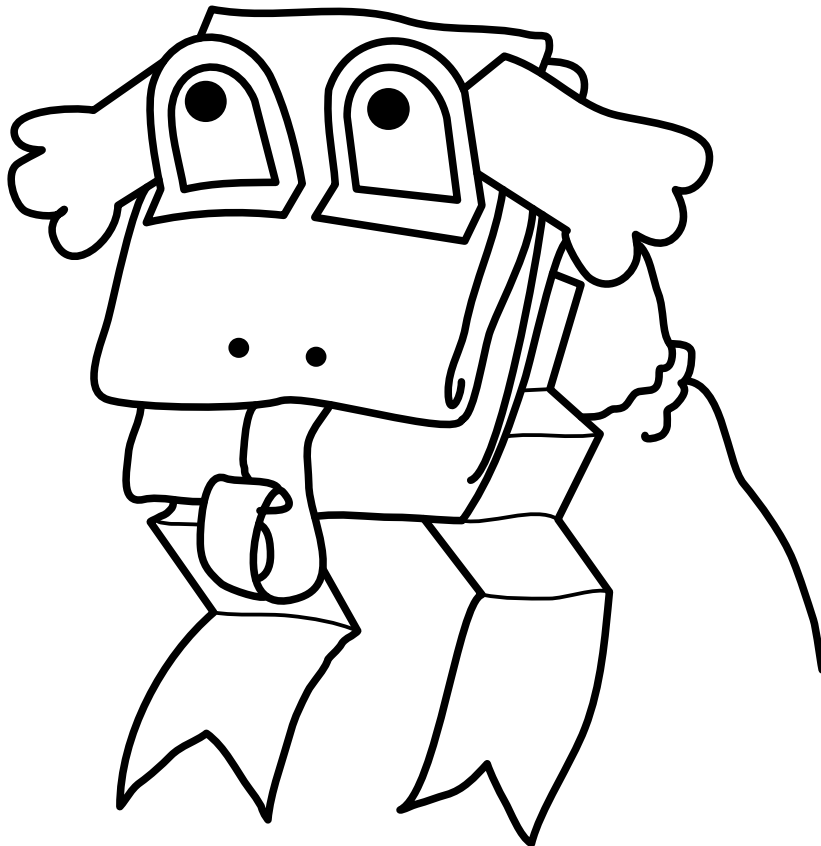

FROG PUPPET PATTERNS

legs

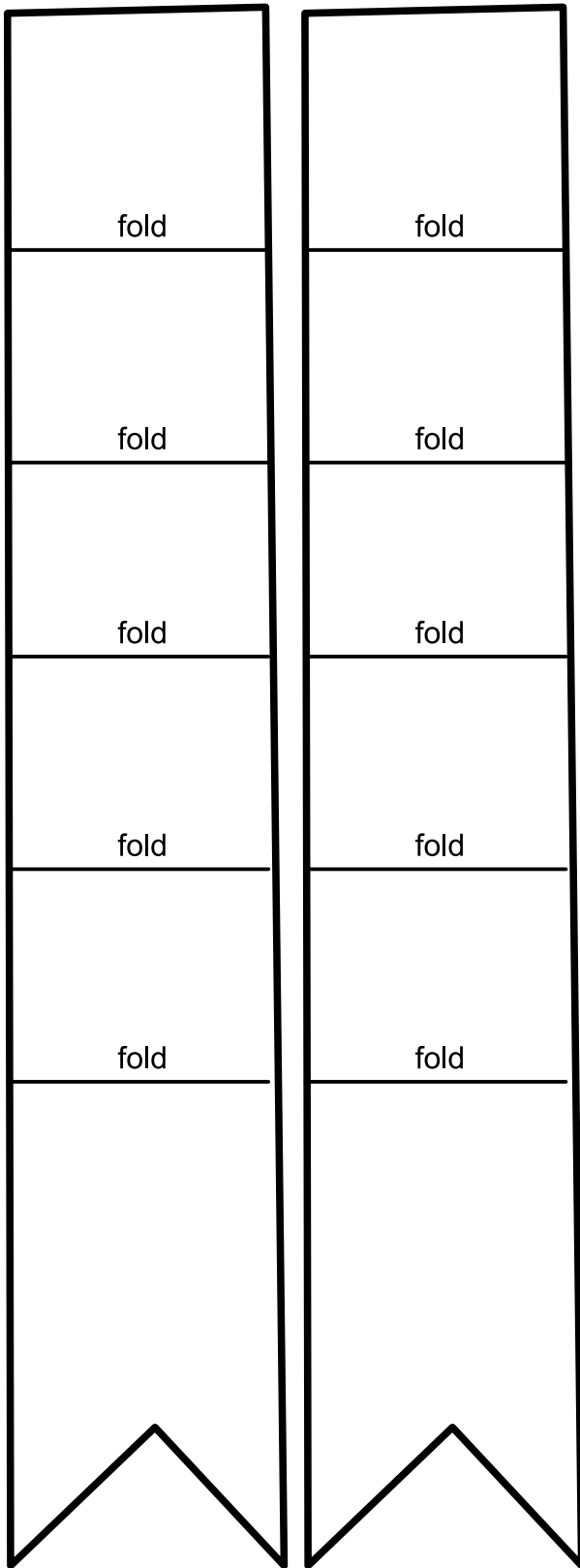

eyes

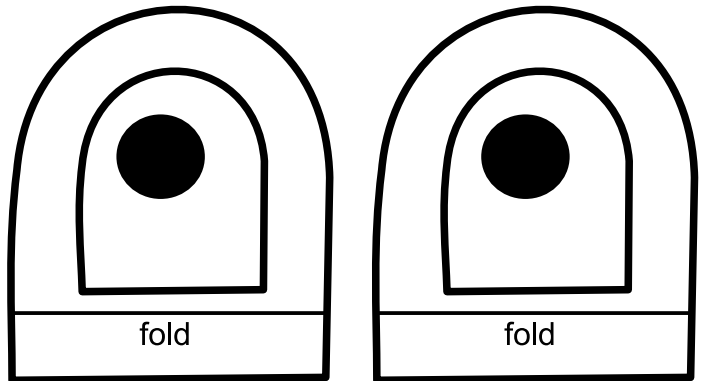

arms

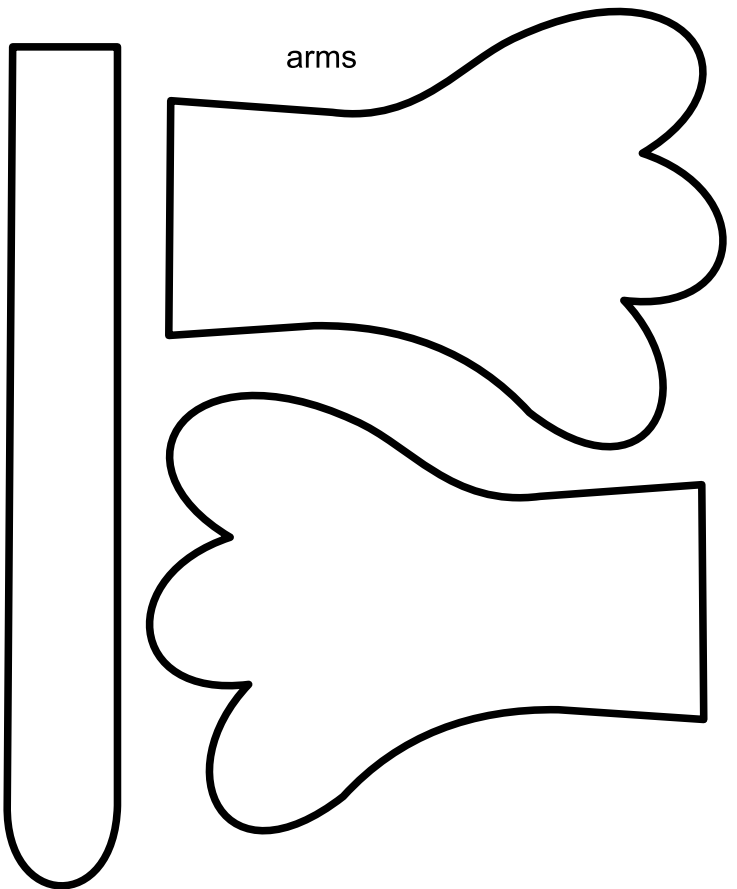

Curl on a pencil.

HIPPO

MATERIALS

- letter sized gray construction paper (for base puppet)
- patterns (p. 232)
- markers or crayons
- scissors
- glue

INSTRUCTIONS

1. Make the basic puppet from the construction paper.
2. Color the pattern pieces and cut out.
3. Glue the pattern pieces onto the basic puppet. (see example)
4. Draw nostrils with crayons or markers.

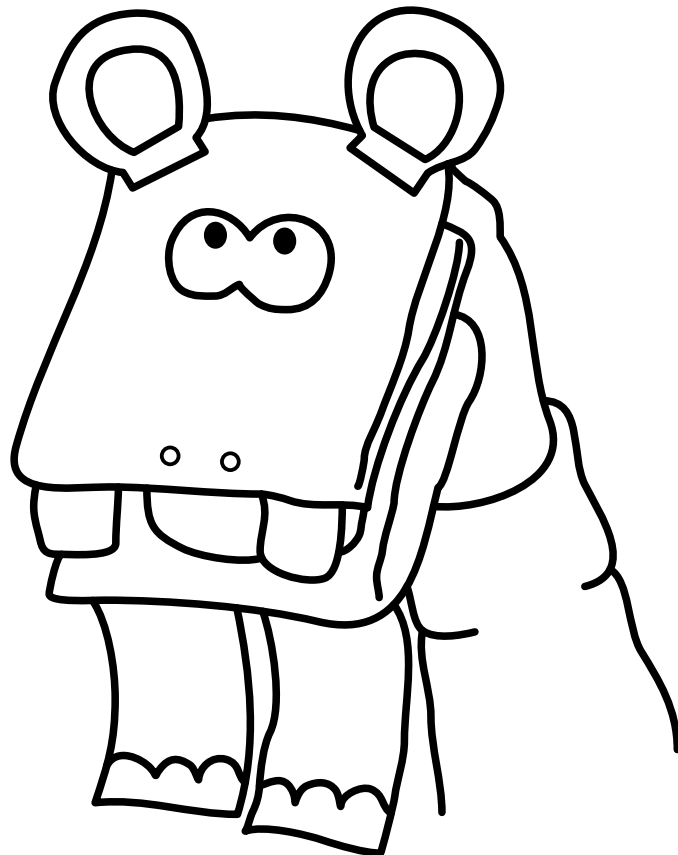

HIPPO PUPPET PATTERNS

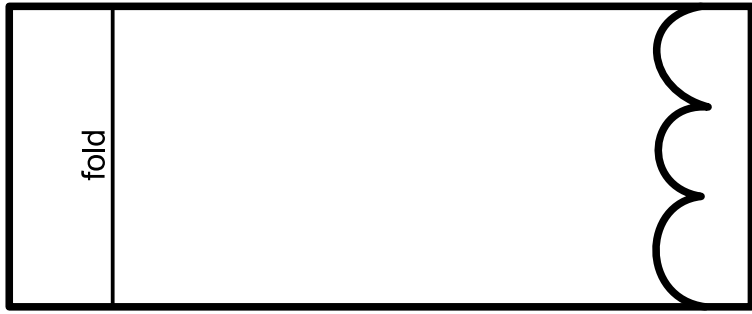

legs

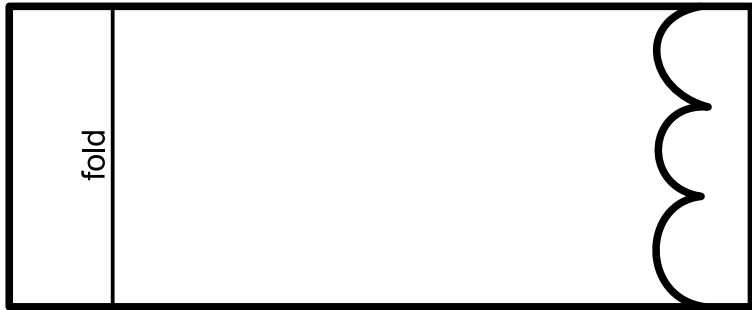

ears

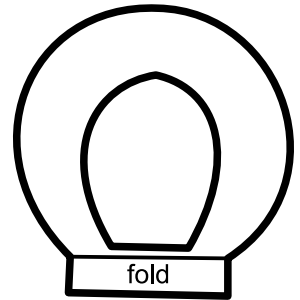
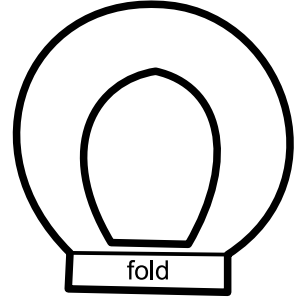

teeth

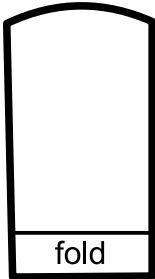
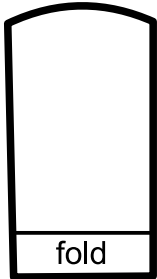

eyes

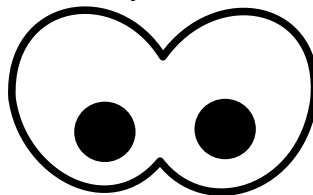

tongue

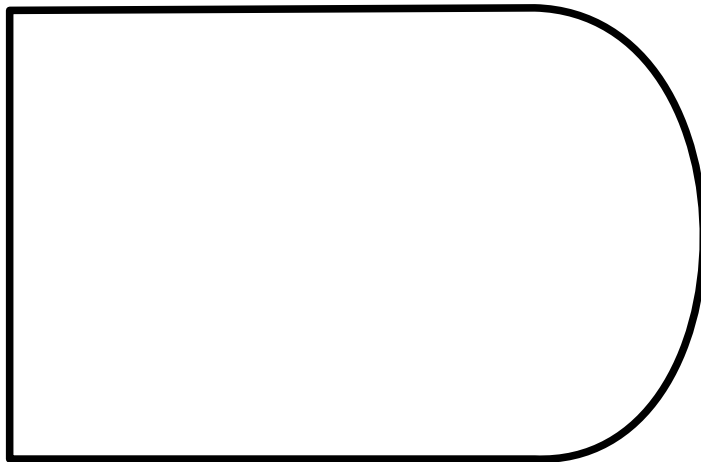

JACKRABBIT

MATERIALS

- letter sized brown construction paper (for base puppet)
- patterns (p. 234)
- markers or crayons
- scissors
- glue

INSTRUCTIONS

1. Make the basic puppet from the construction paper.
2. Color the pattern pieces and cut out.
3. Glue the pattern pieces onto the basic puppet. (see example)
4. Draw eyes with crayons or markers.

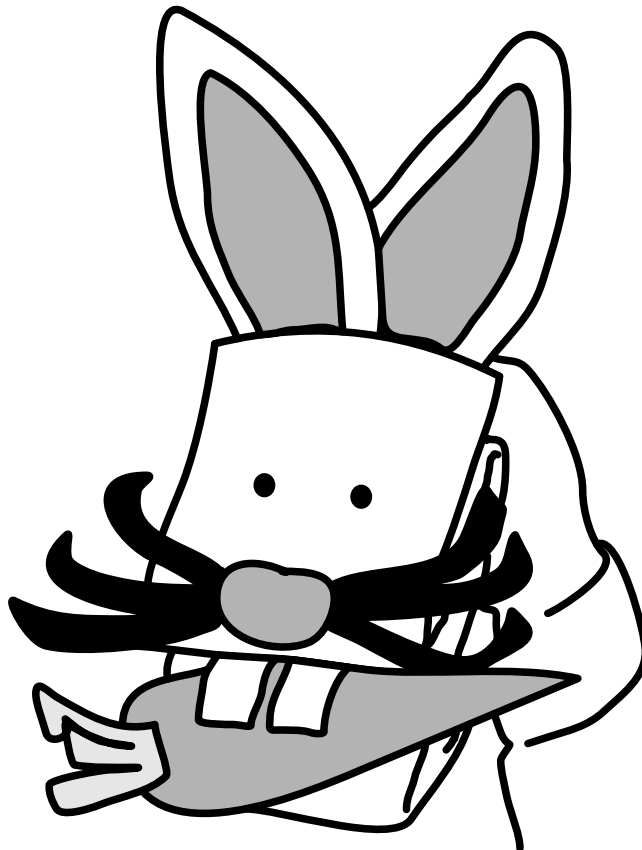

JACKRABBIT PUPPET PATTERNS



carrot top

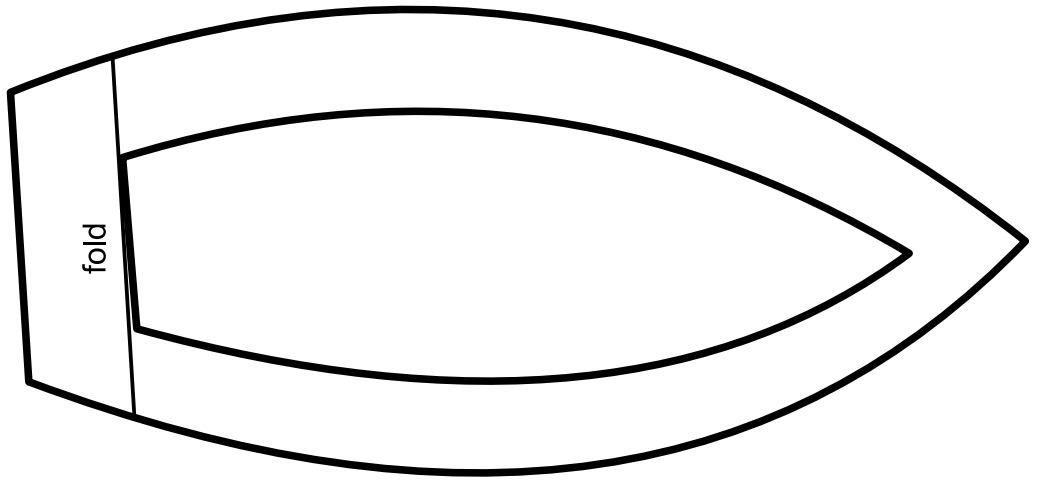

fold

ears

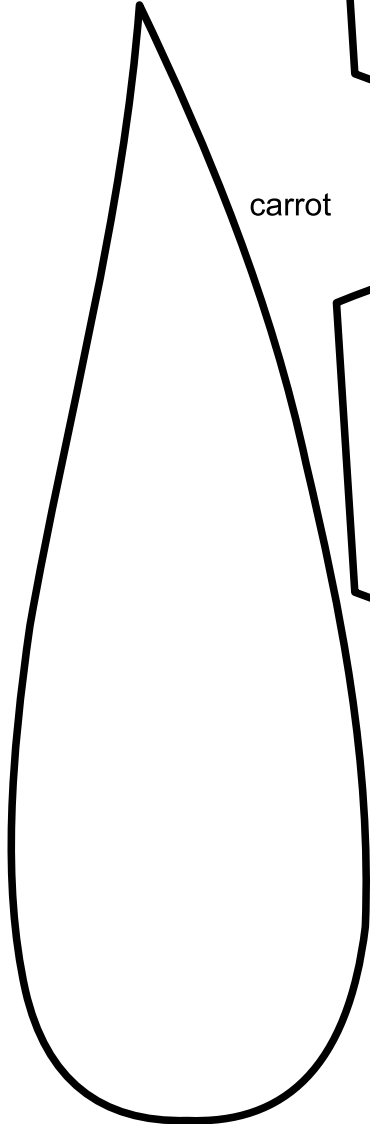

carrot

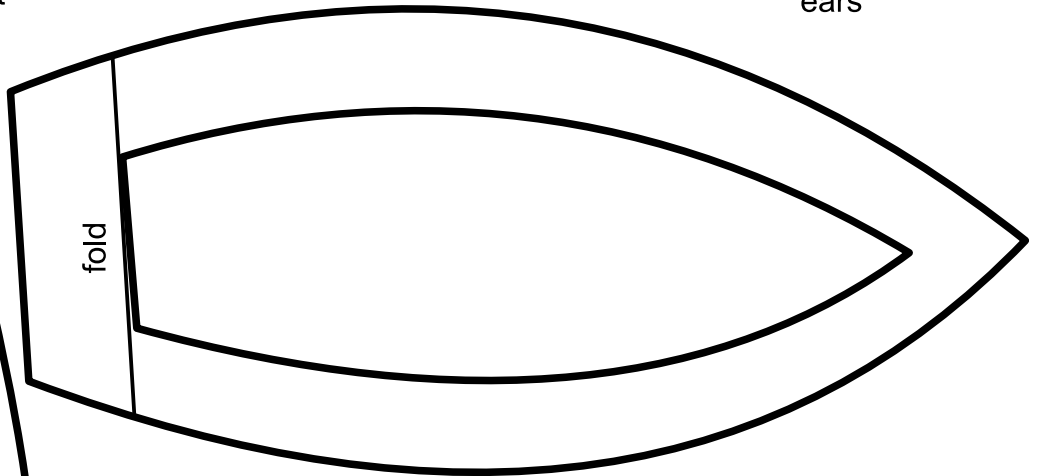

fold

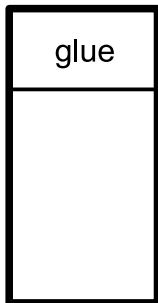

glue

teeth

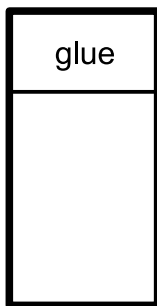

glue

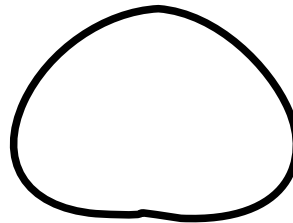

nose



whiskers

PAPER MITT PUPPETS

BASE PUPPET

MATERIALS

- letter sized construction paper
- scissors
- glue

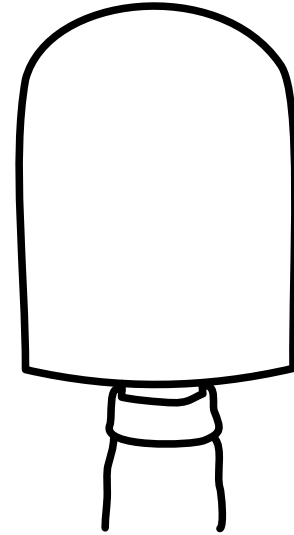

INSTRUCTIONS

1. Place the construction paper lengthwise. Fold in half. (see fig. 1)
2. Using the scissors, round the top. (see fig. 2)
3. Unfold and apply glue to the edge. (see fig. 3)
4. Fold and press. (see fig. 4)

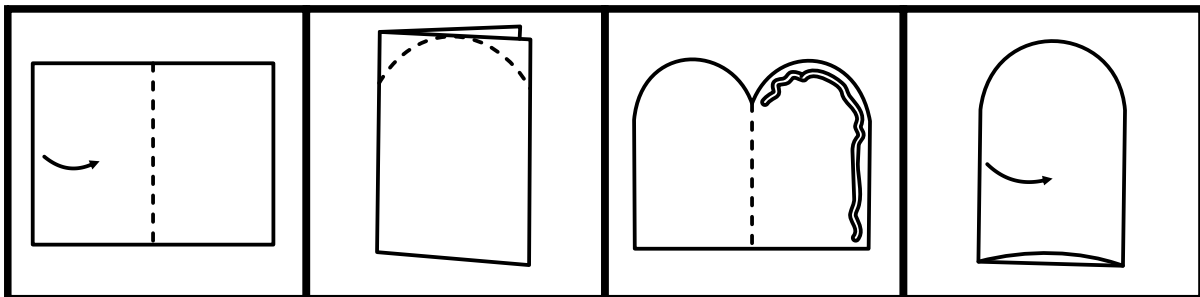

FIGURE 1

FIGURE 2

FIGURE 3

FIGURE 4

ALIEN

MATERIALS

- letter sized orange construction paper (for base puppet)
- patterns (p. 237)
- markers or crayons
- scissors
- glue

INSTRUCTIONS

1. Make the basic puppet from the construction paper.
2. Color the pattern pieces and cut out.
3. Glue the pattern pieces onto the basic puppet. (see example)
4. Add details with crayons or markers.

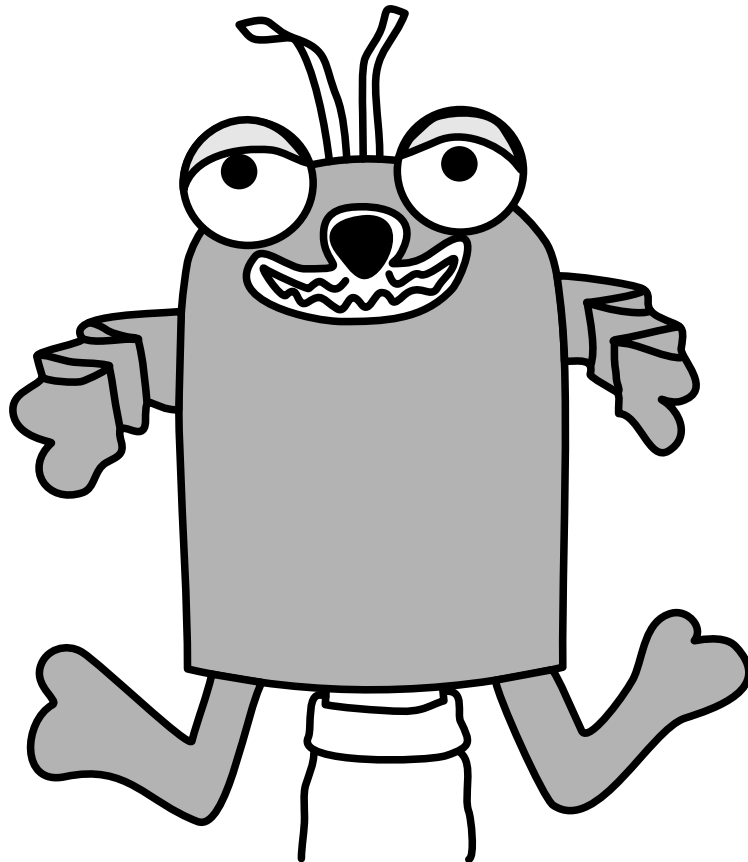

ALIEN PUPPET PATTERNS

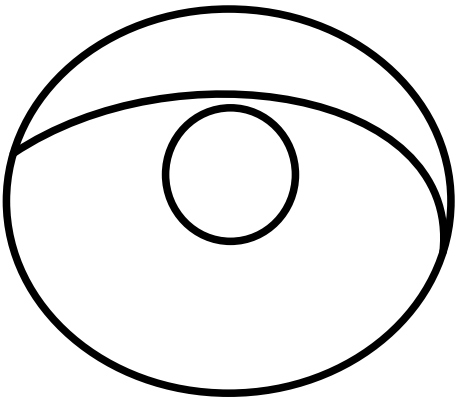

eye

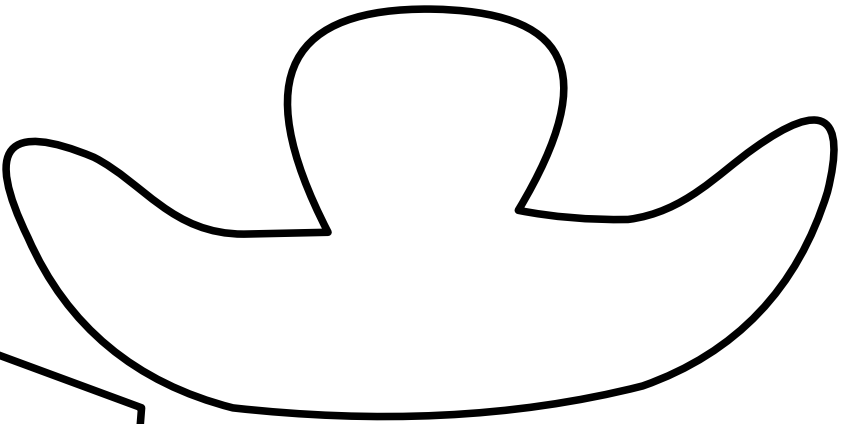

nose and mouth

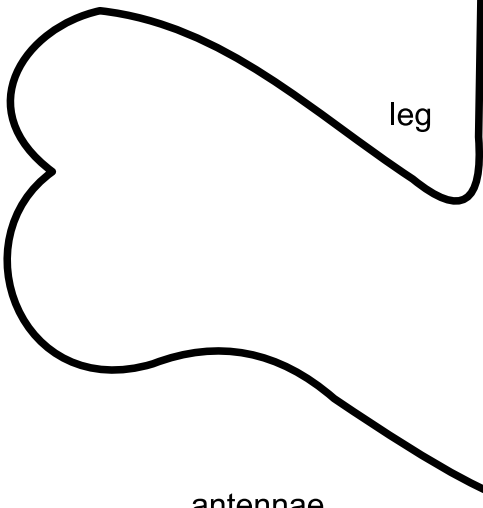

leg

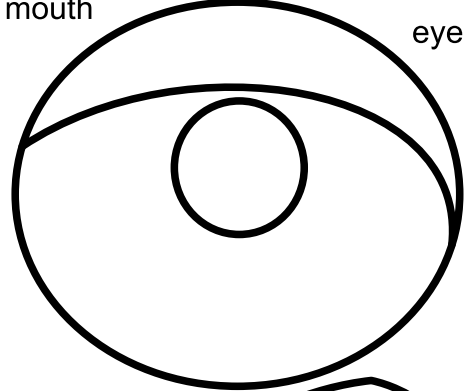

eye

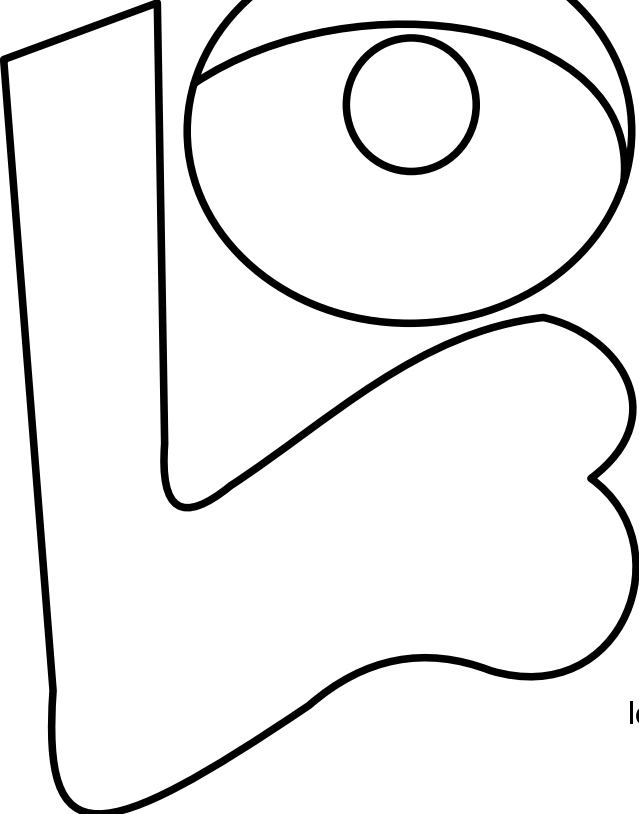

leg



antennae

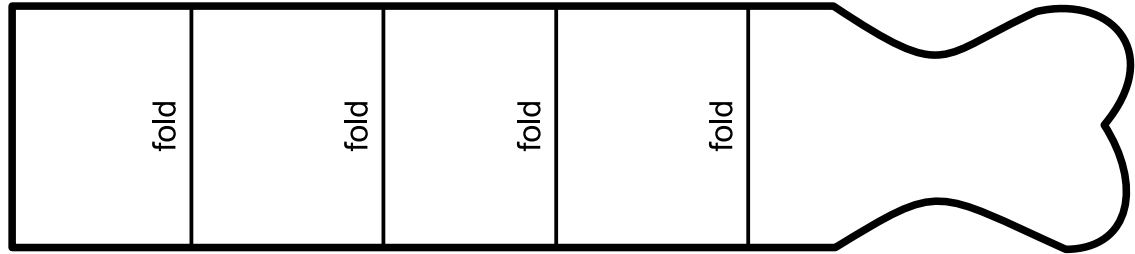

arms

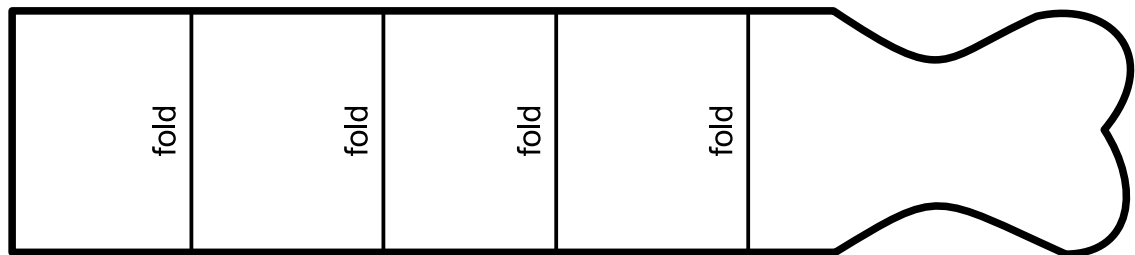

ASTRONAUT

MATERIALS

- letter sized white construction paper (for base puppet)
- patterns (p. 239)
- markers or crayons
- scissors
- glue

INSTRUCTIONS

1. Make the basic puppet from the construction paper.
2. Color the pattern pieces and cut out.
3. Glue the pattern pieces onto the basic puppet. (see example)
4. Add details with crayons or markers.

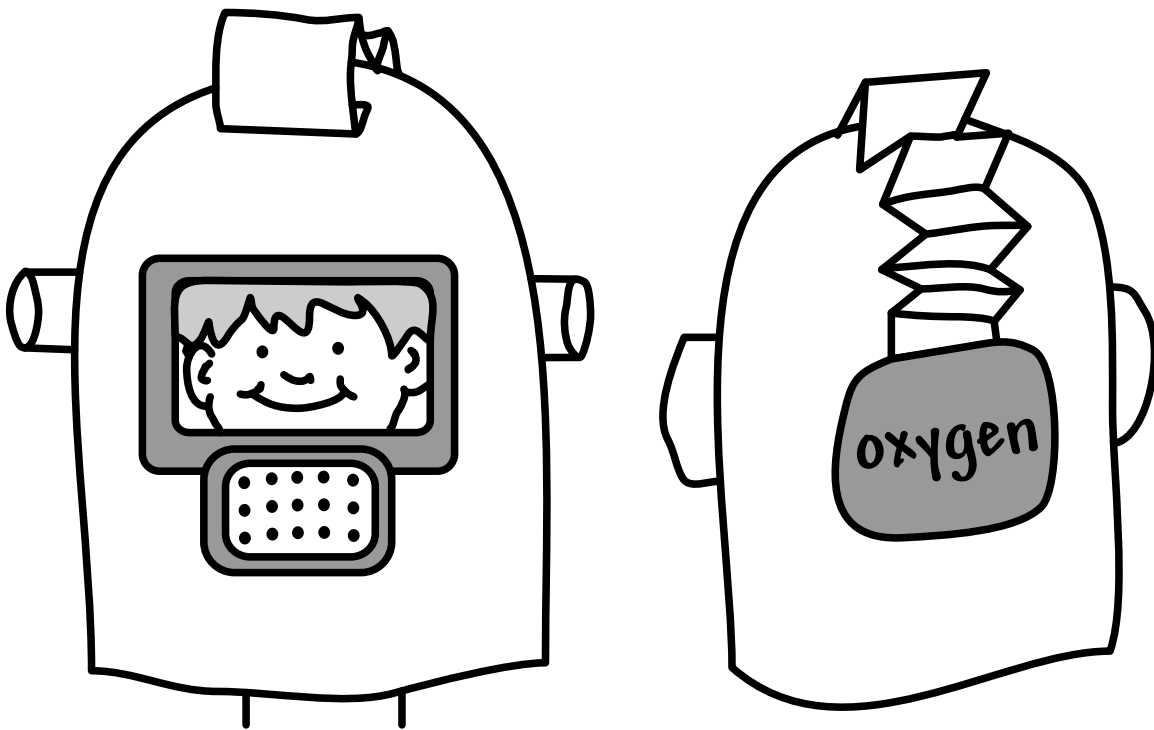

ASTRONAUT PUPPET PATTERNS

air hose

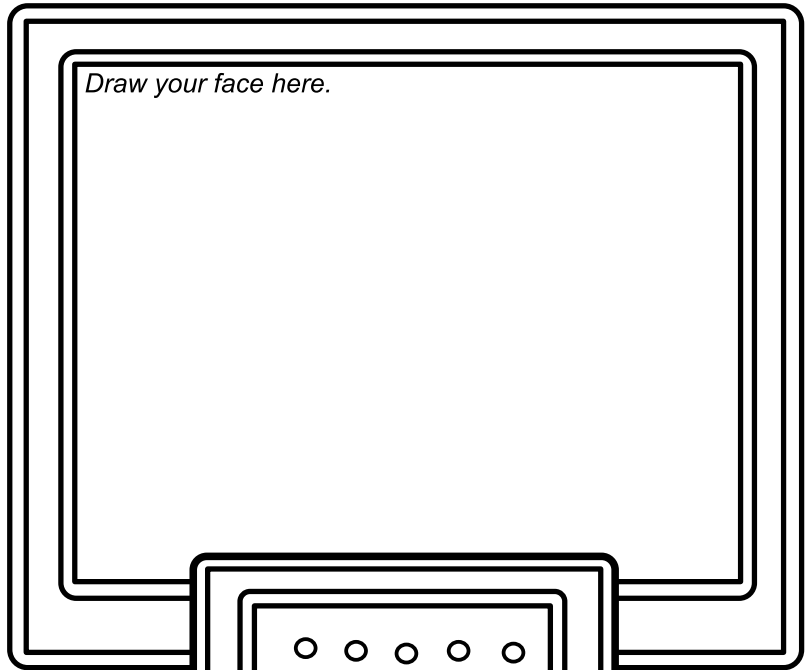
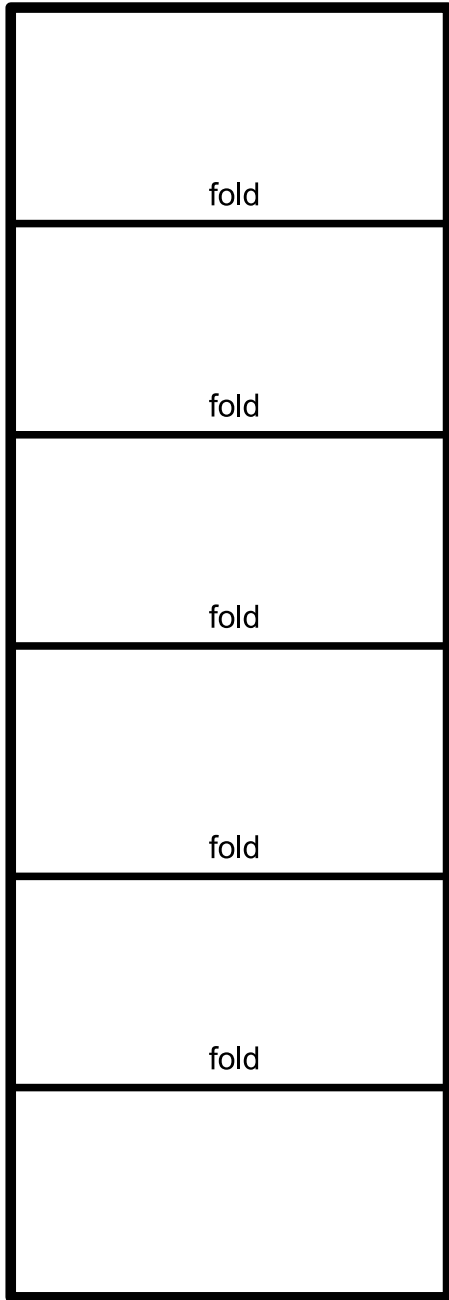

Draw your face here.

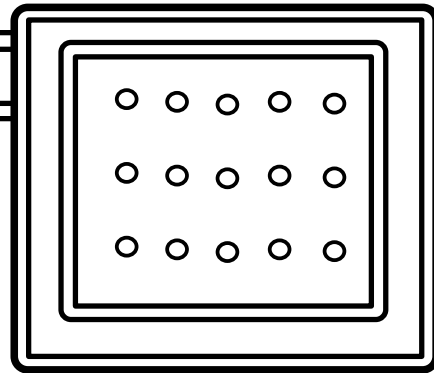

faceplate

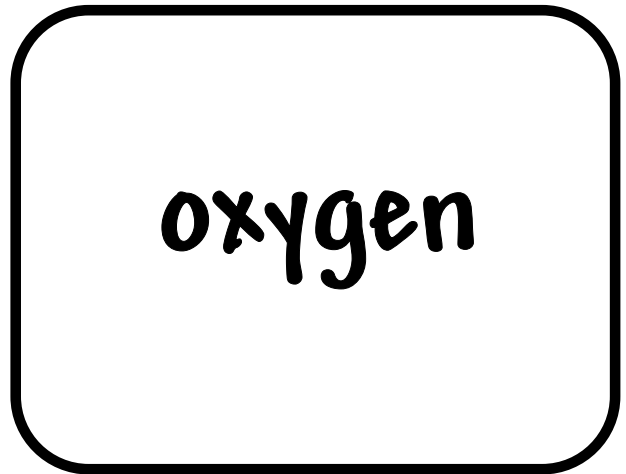

oxygen tank

earpieces

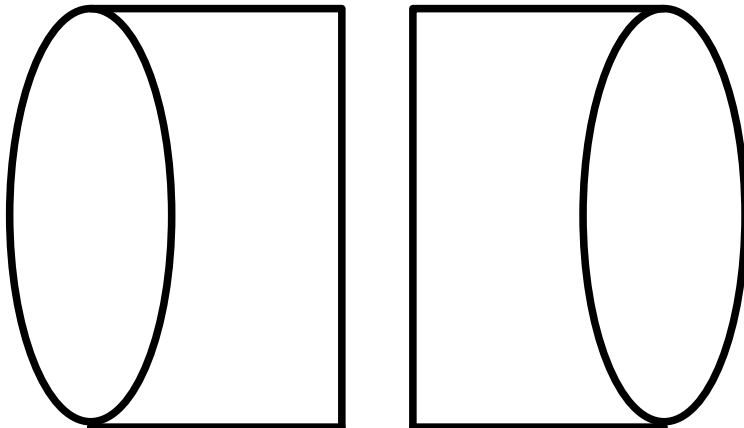

BEAR

MATERIALS

- letter sized brown construction paper (for base puppet)
- patterns (p. 241)
- markers or crayons
- scissors
- glue

INSTRUCTIONS

1. Make the basic puppet from the construction paper.
2. Color the pattern pieces and cut out.
3. Glue the pattern pieces onto the basic puppet. (see example)
4. Draw freckles on the snout with crayons or markers.

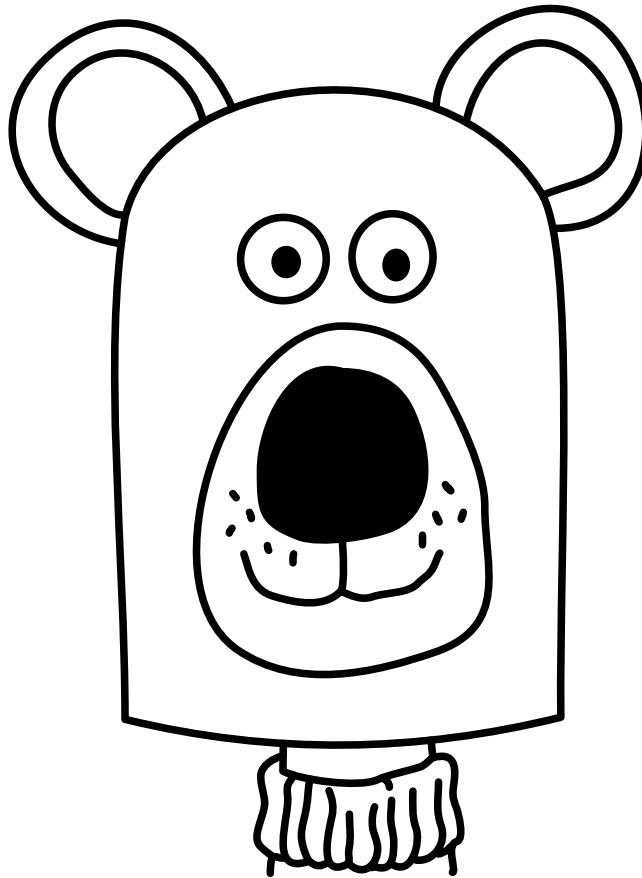

BEAR PUPPET PATTERNS

snout

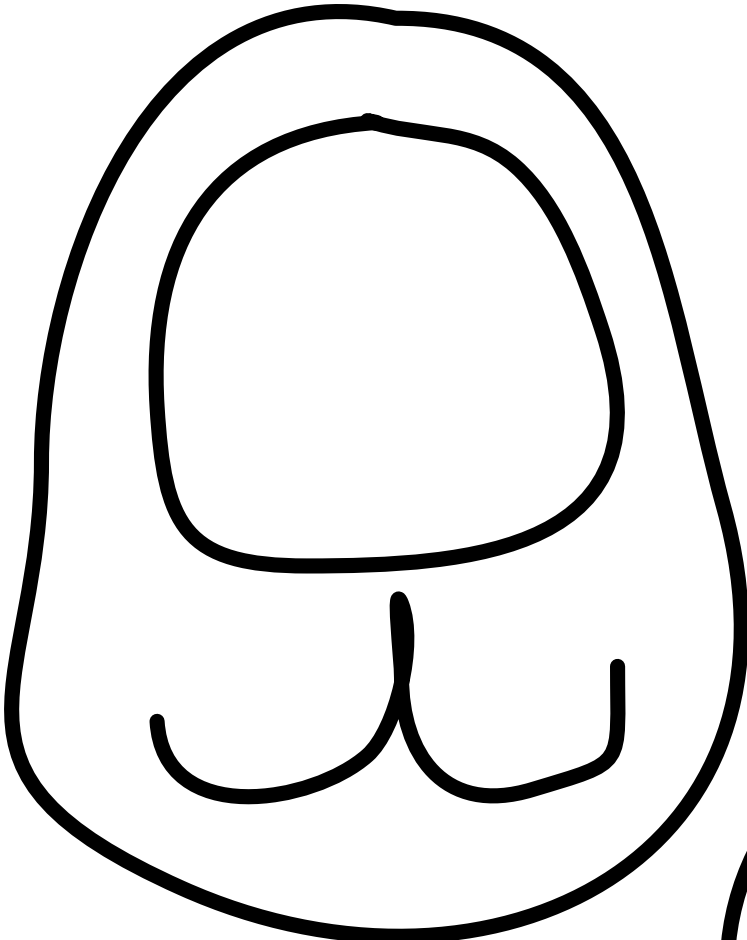

eyes

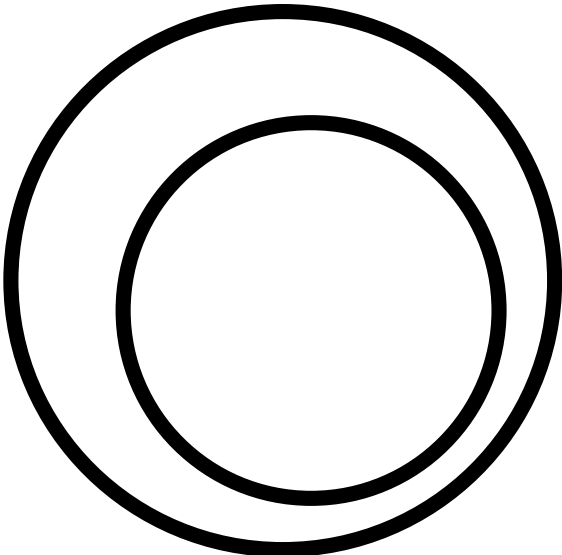
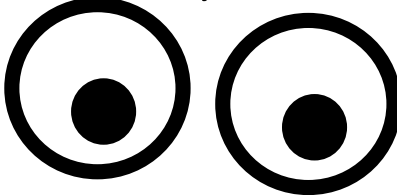

ears

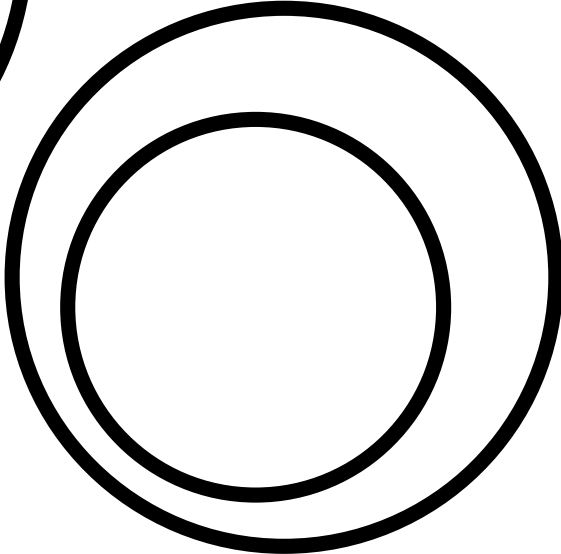

BEAVER

MATERIALS

- letter sized brown construction paper (for base puppet)
- patterns (p. 243)
- markers or crayons
- scissors
- glue

INSTRUCTIONS

1. Make the basic puppet from the construction paper.
2. Color the pattern pieces and cut out.
3. Glue the pattern pieces onto the basic puppet. (see example)
4. Draw eyes with crayons or markers.

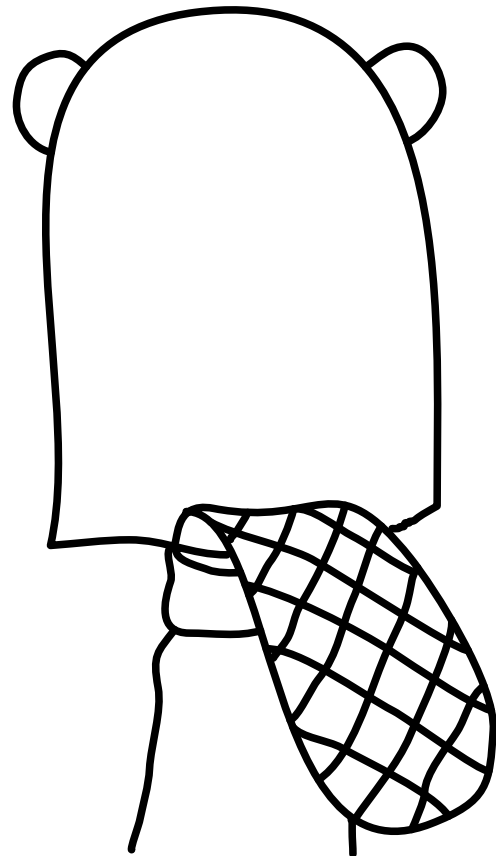
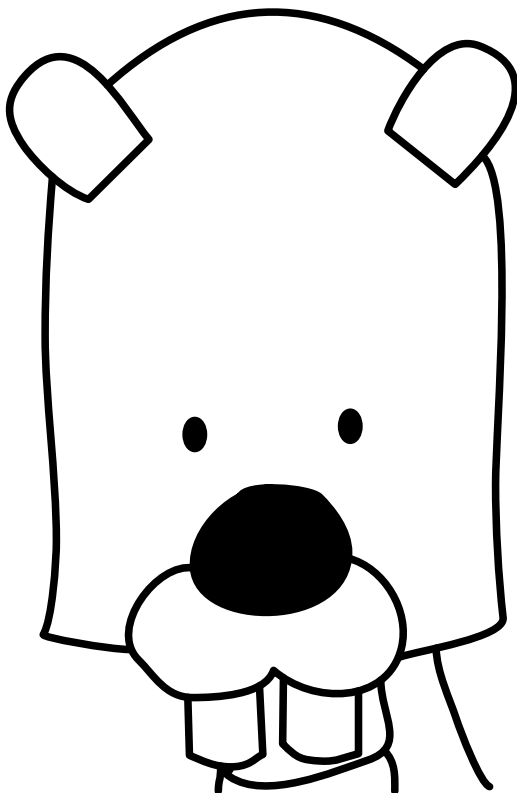

BEAVER PUPPET PATTERNS

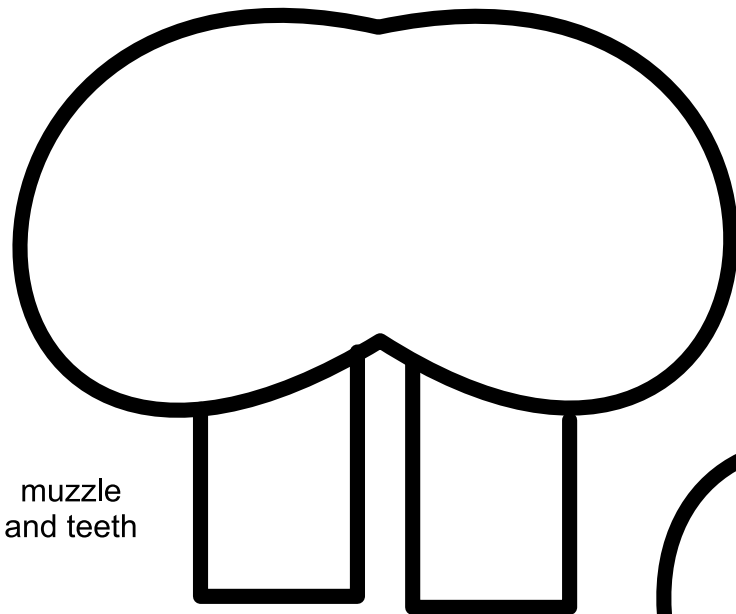

muzzle
and teeth

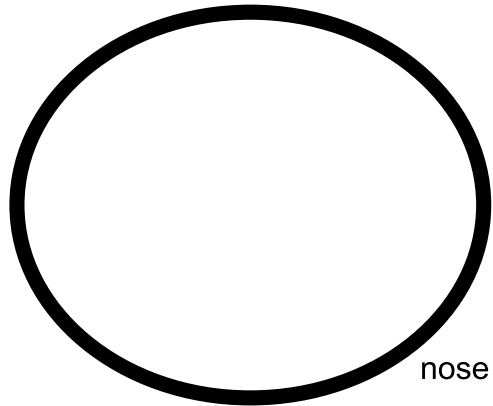

nose

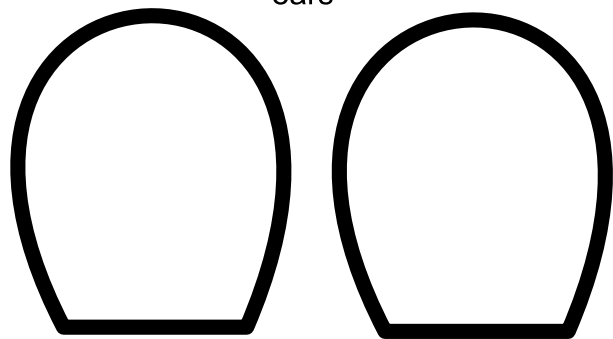

ears

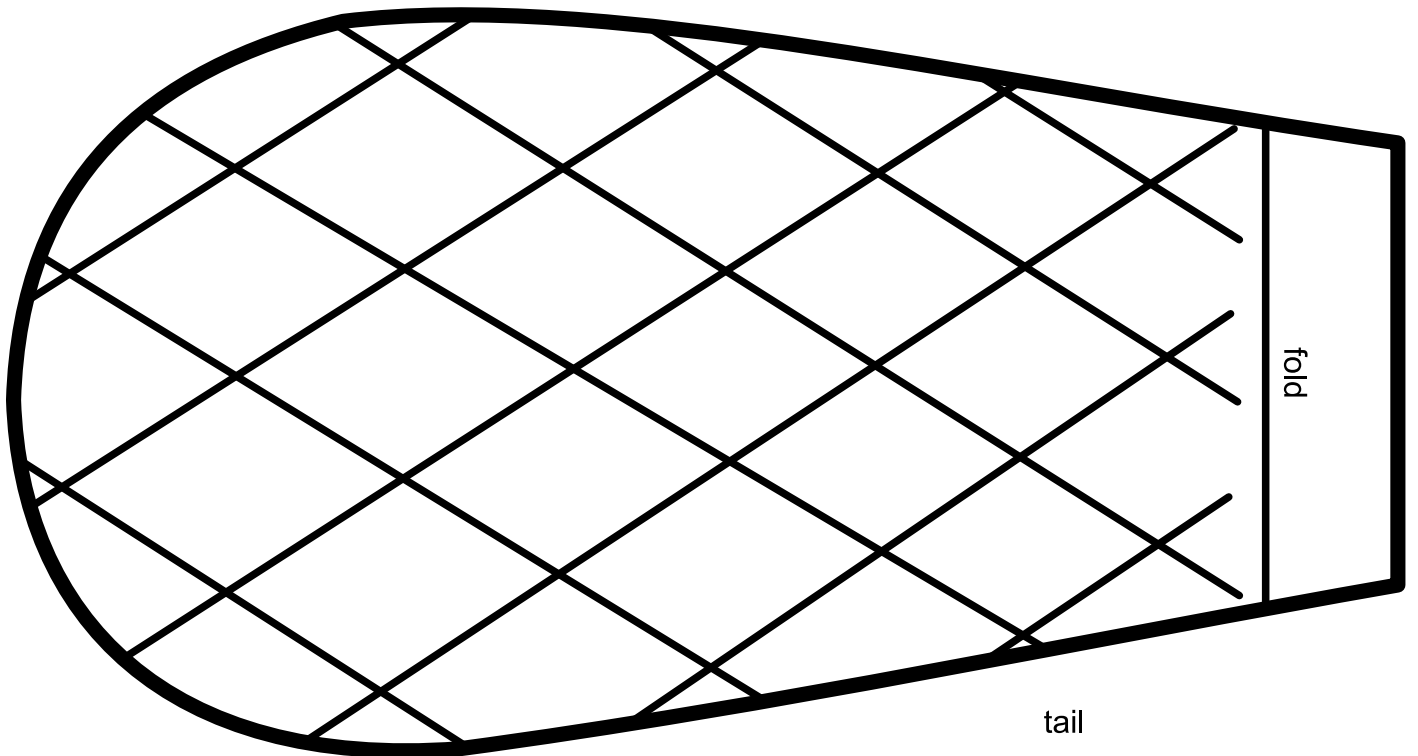

fold

tail

CAT

MATERIALS

- letter sized yellow construction paper (for base puppet)
- patterns (p. 245)
- markers or crayons
- scissors
- glue

INSTRUCTIONS

1. Make the basic puppet from the construction paper.
2. Color the pattern pieces and cut out.
3. Glue the pattern pieces onto the basic puppet. (see example)
4. Draw eyes with crayons or markers.

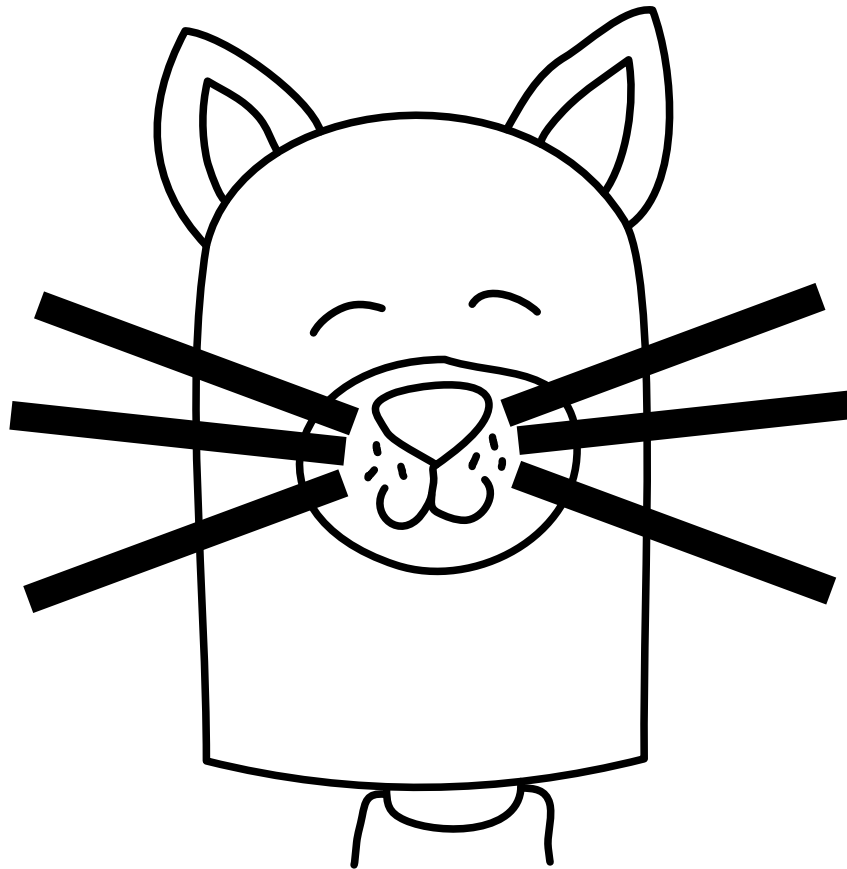

CAT PUPPET PATTERNS

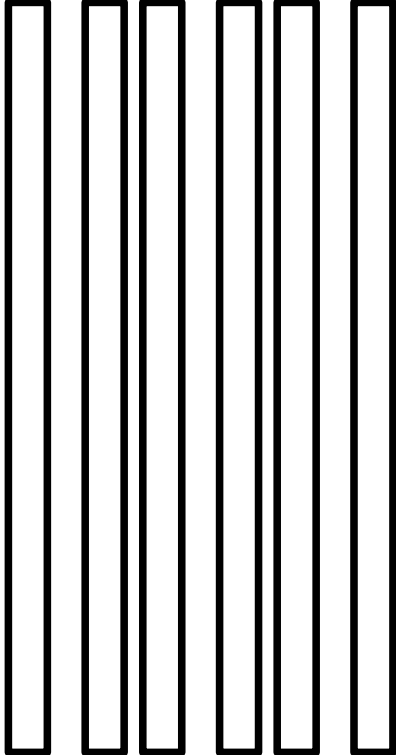
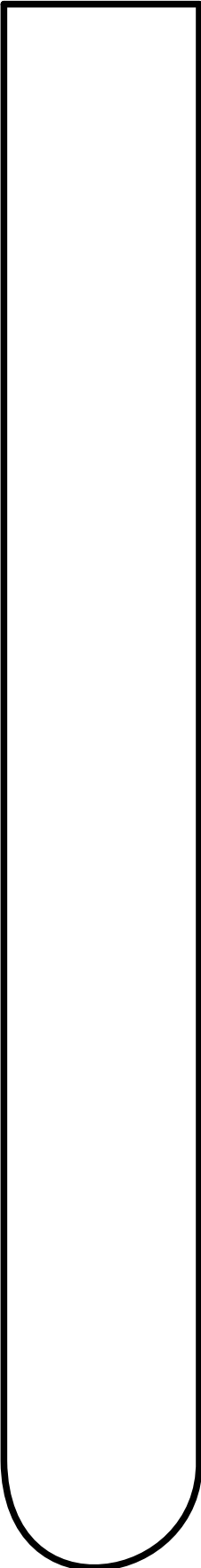

whiskers

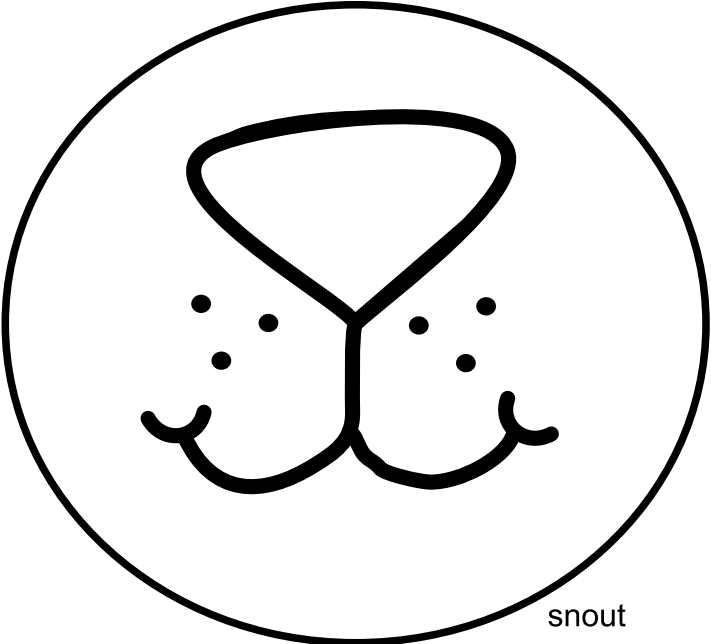

snout

tail

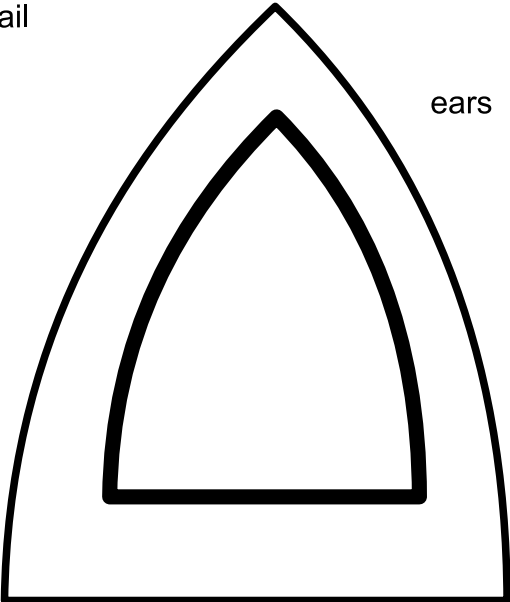

ears

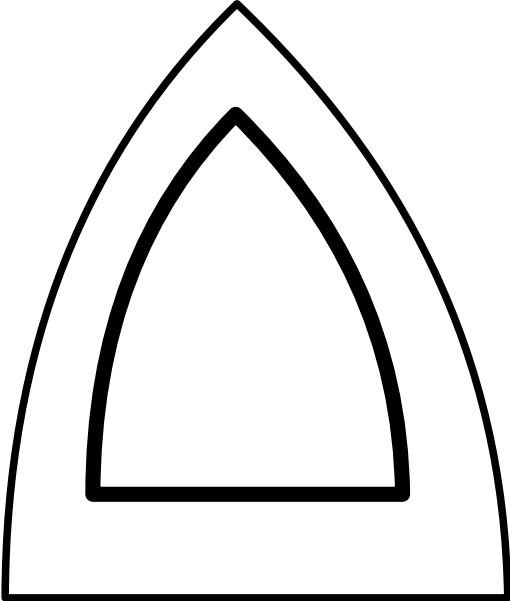

DOG

MATERIALS

- letter sized white construction paper (for base puppet)
- patterns (p. 247)
- markers or crayons
- scissors
- glue

INSTRUCTIONS

1. Make the basic puppet from the construction paper.
2. Color the pattern pieces and cut out.
3. Glue the pattern pieces onto the basic puppet. (see example)
4. Add freckles on the muzzle with crayons or markers.

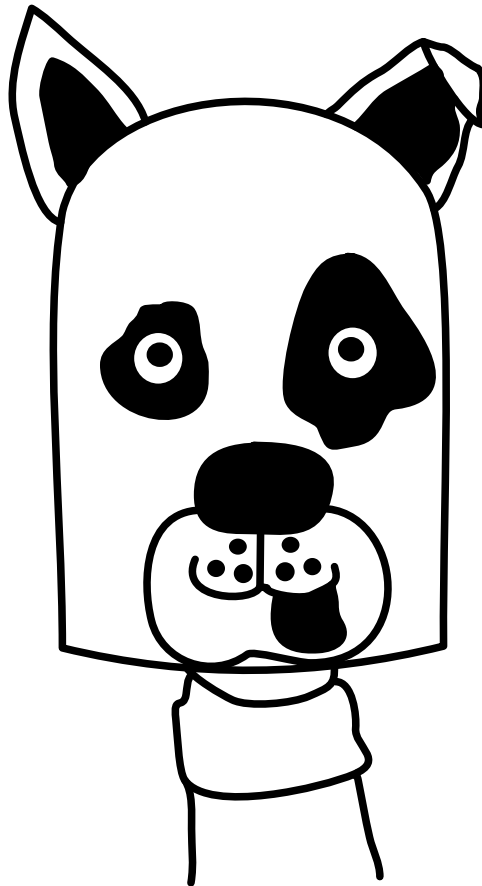

DOG PUPPET PATTERNS

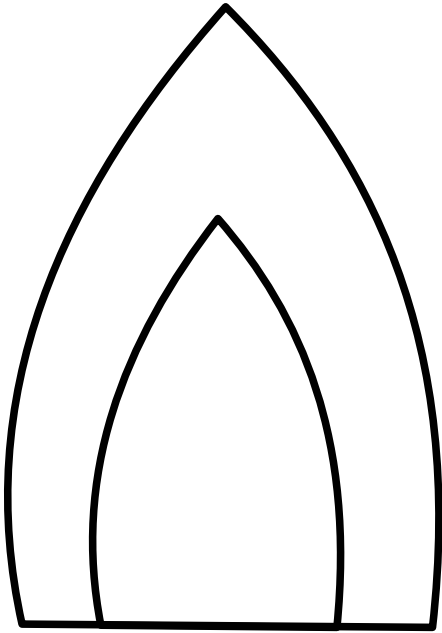

ears

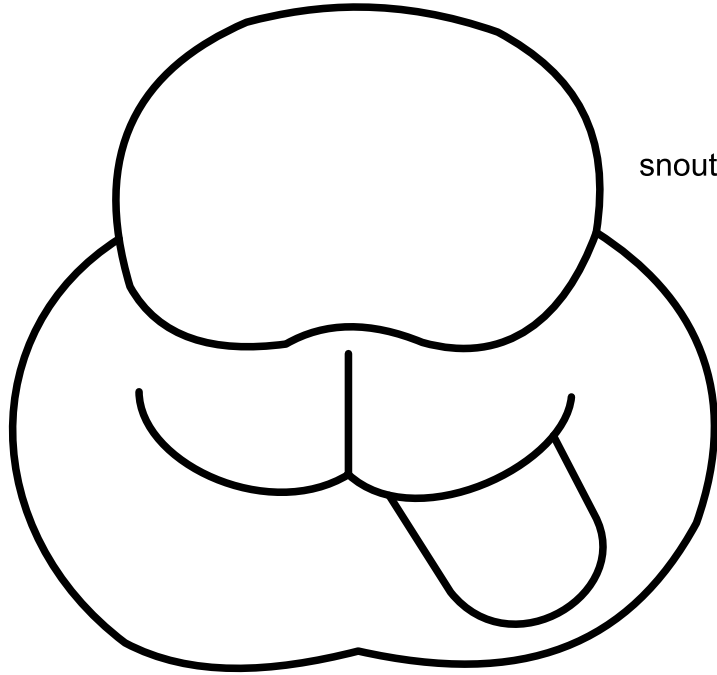

snout

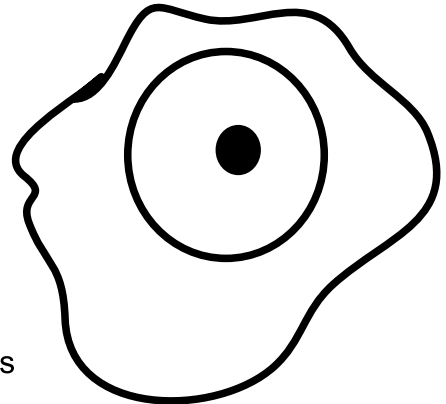
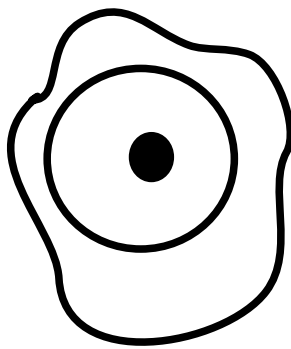
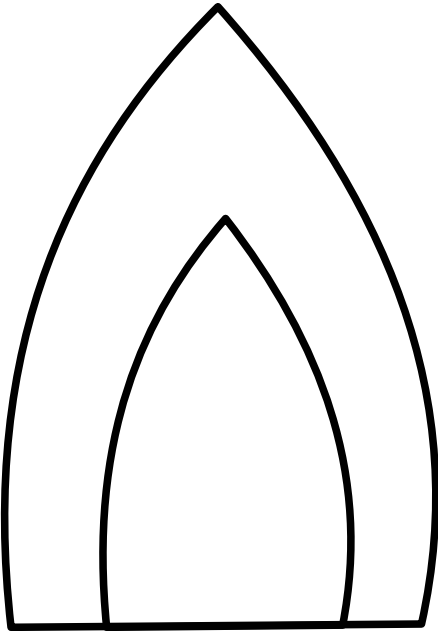

eyes

ELEPHANT

MATERIALS

- letter sized gray construction paper (for base puppet)
- patterns (p. 249)
- markers or crayons
- scissors
- glue

INSTRUCTIONS

1. Make the basic puppet from the construction paper.
2. Color the pattern pieces and cut out.
3. Glue the pattern pieces onto the basic puppet. (see example)
4. Draw eyes with crayons or markers.

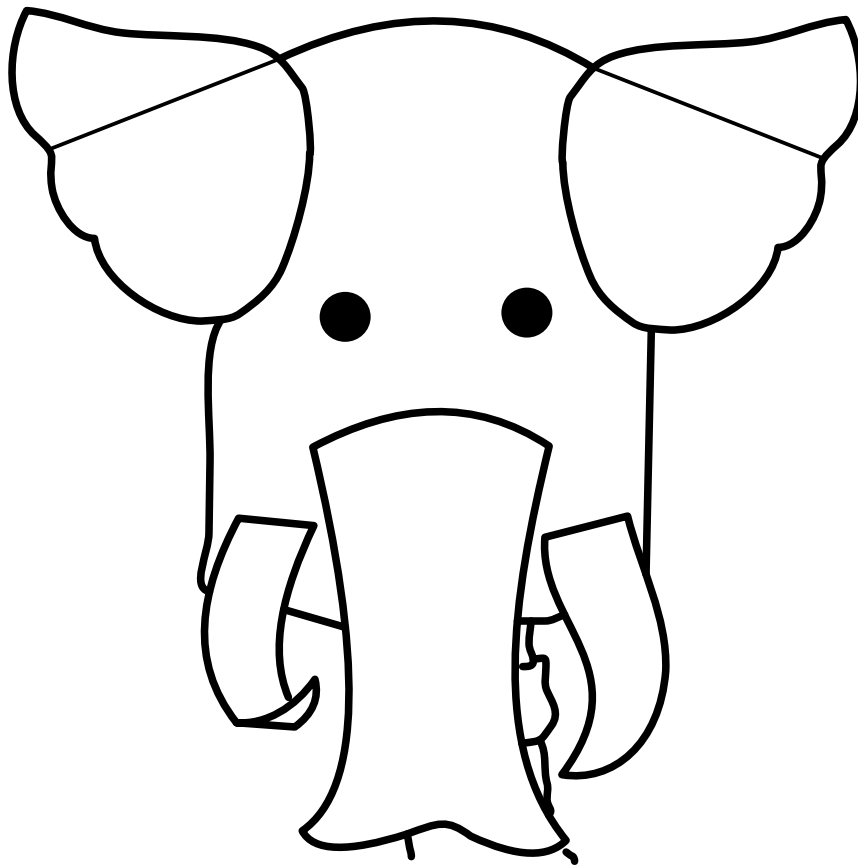

ELEPHANT PUPPET PATTERNS

ear

tusk

fold

fold

tusk

ear

trunk

HEN

MATERIALS

- letter sized yellow construction paper (for base puppet)
- patterns (p. 251)
- markers or crayons
- scissors
- glue

INSTRUCTIONS

1. Make the basic puppet from the construction paper.
2. Color the pattern pieces and cut out.
3. Glue the pattern pieces onto the basic puppet. (see example)

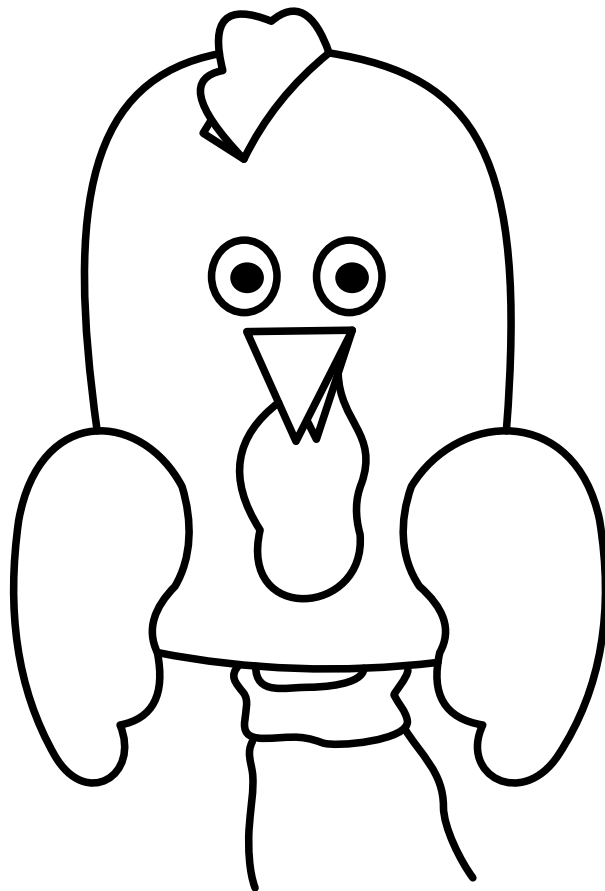

HEN PUPPET PATTERNS

comb

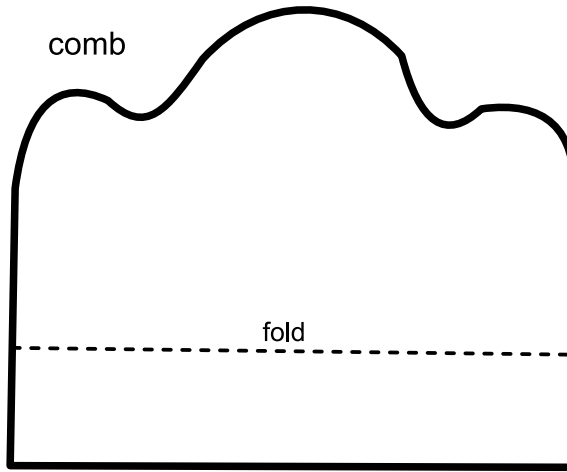

eyes

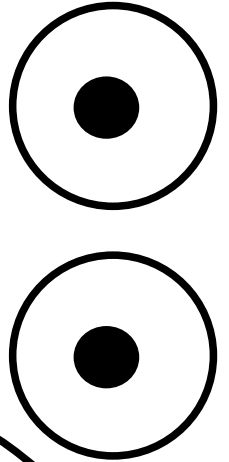

waddle

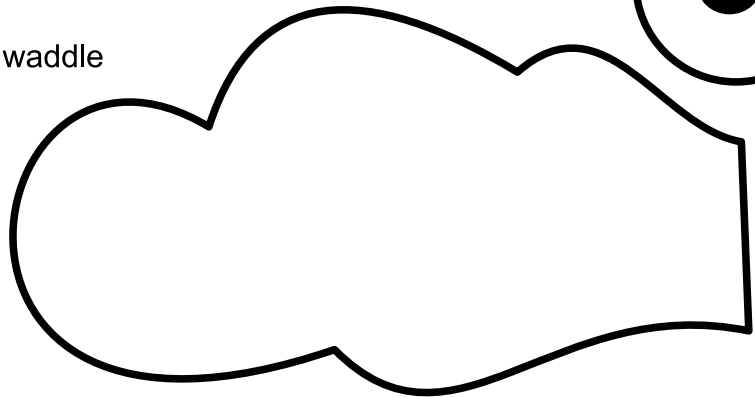

wings

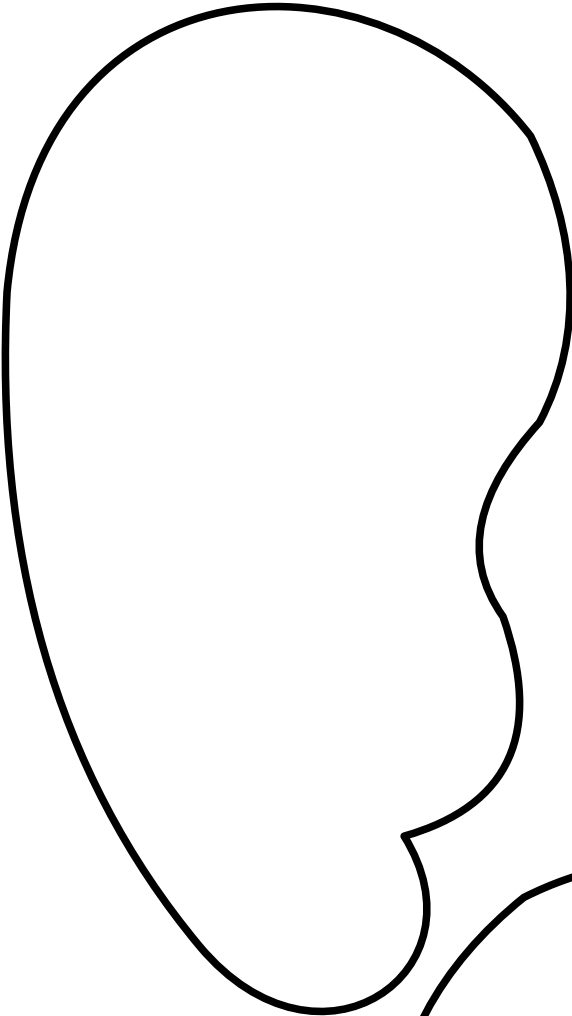

fold

beak

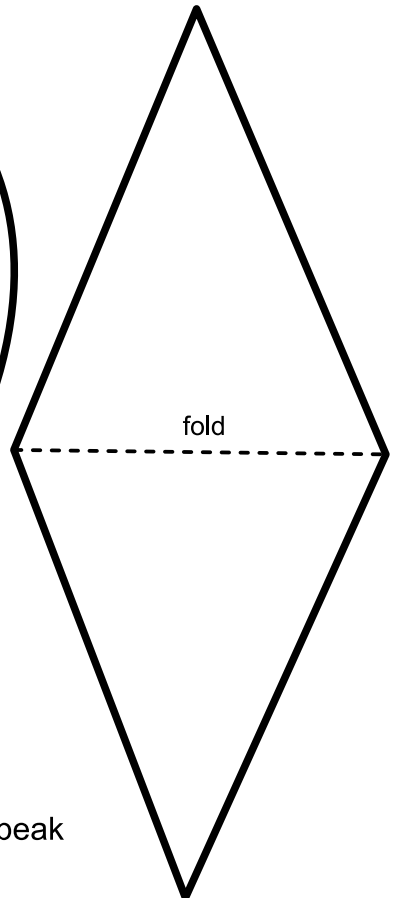

KNIGHT

MATERIALS

- letter sized gray construction paper (for base puppet)
- patterns (p. 253)
- markers or crayons
- scissors
- glue
- hole punch

INSTRUCTIONS

1. Make the basic puppet from the construction paper.
2. Color the pattern pieces and cut out.
3. Glue the pattern pieces onto the basic puppet. (see example)
4. Punch holes along the lower edge of the puppet.

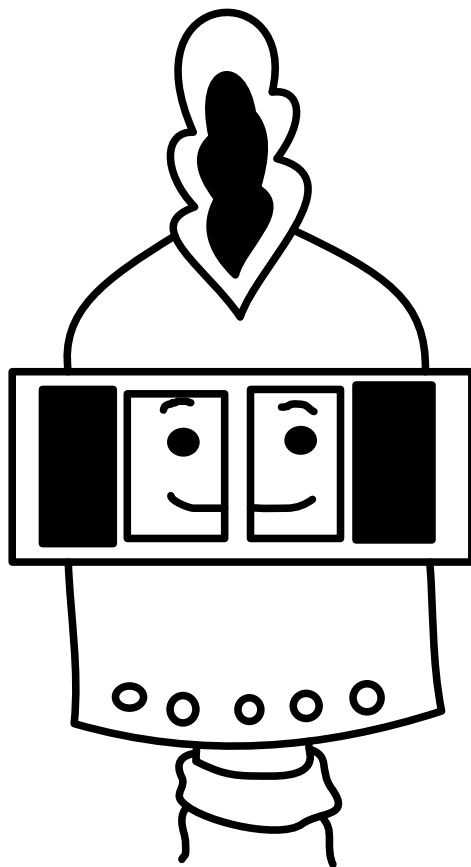

faceplate

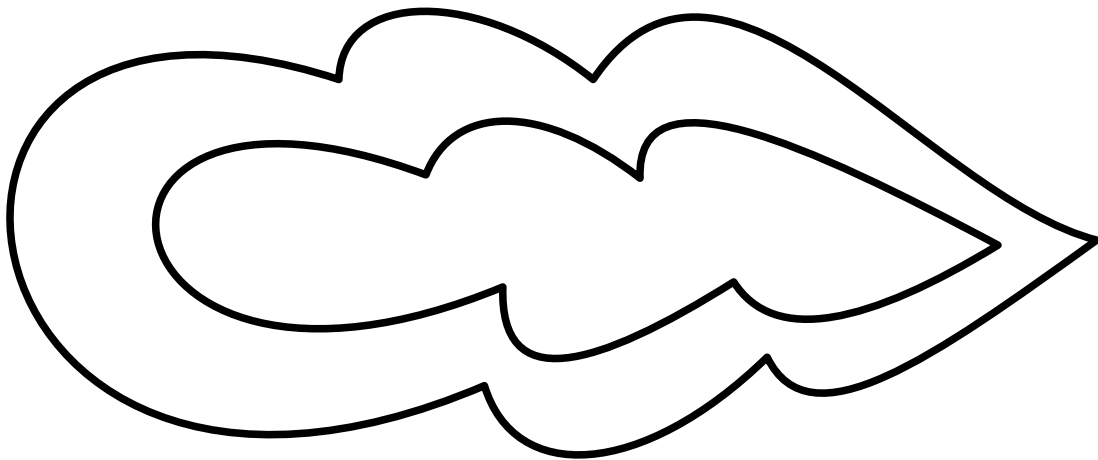
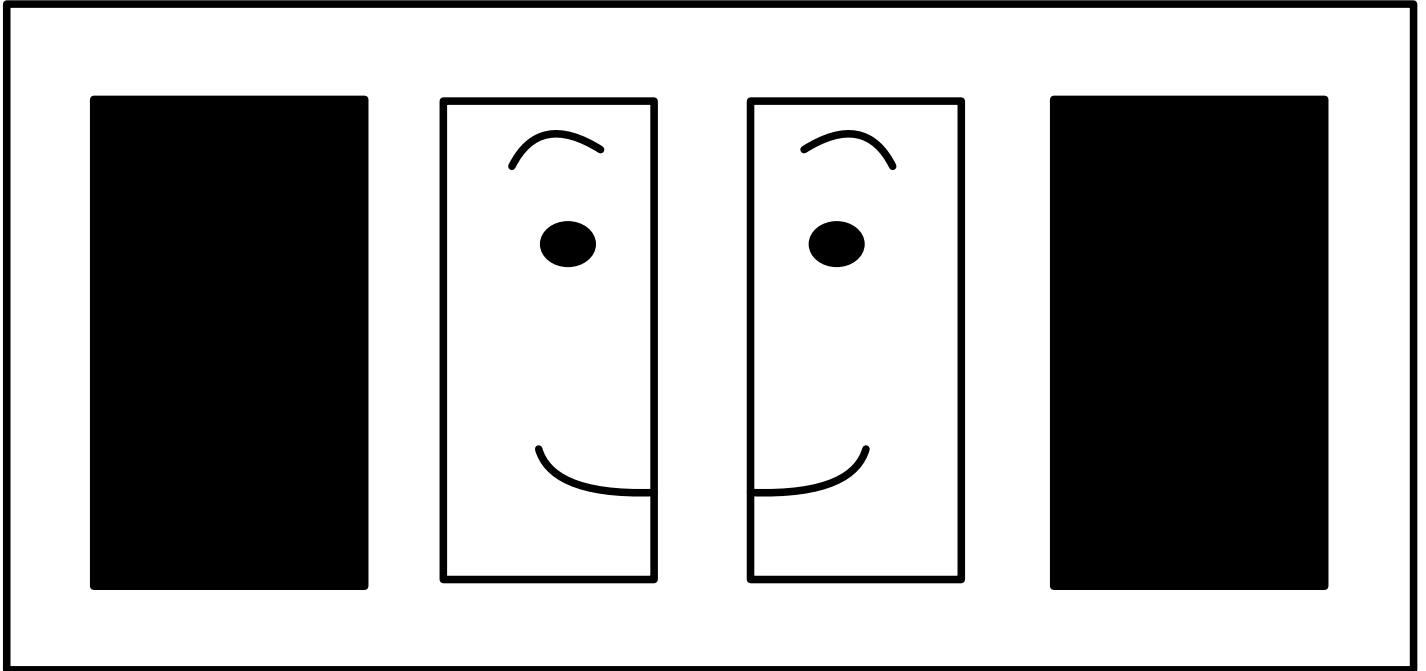

plume for helmet

LAMB

MATERIALS

- letter sized white construction paper (for base puppet)
- patterns (p. 255)
- markers or crayons
- scissors
- glue

INSTRUCTIONS

1. Make the basic puppet from the construction paper.
2. Color the pattern pieces and cut out.
3. Glue the pattern pieces onto the basic puppet. (see example)
4. Draw eyes with crayons or markers.

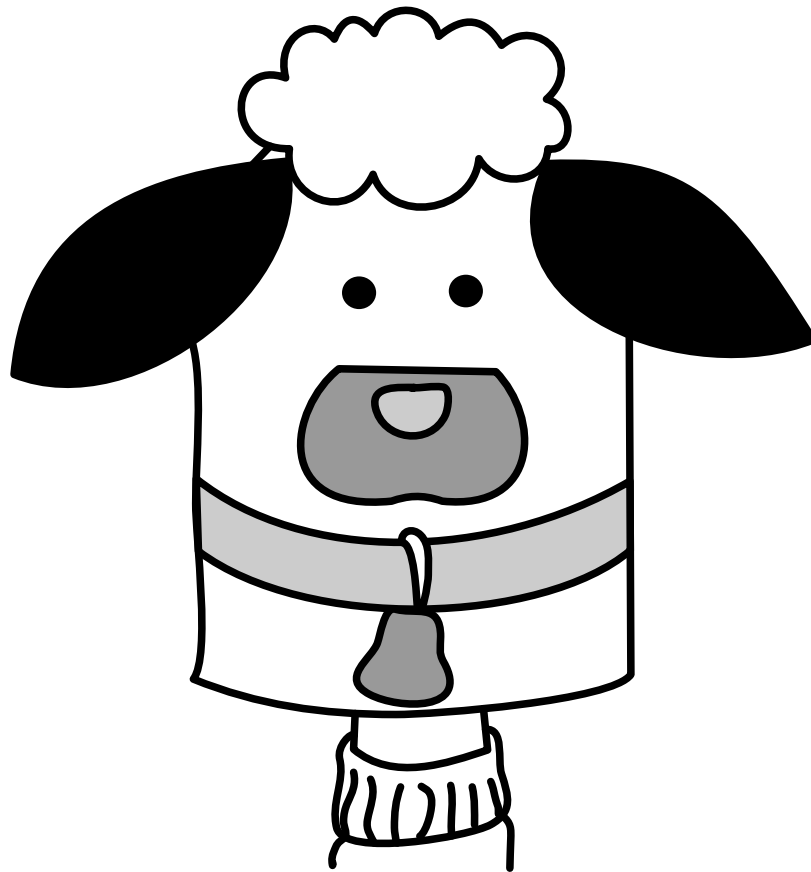

LAMB PUPPET PATTERNS

bell

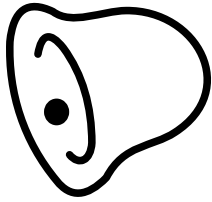

topknot

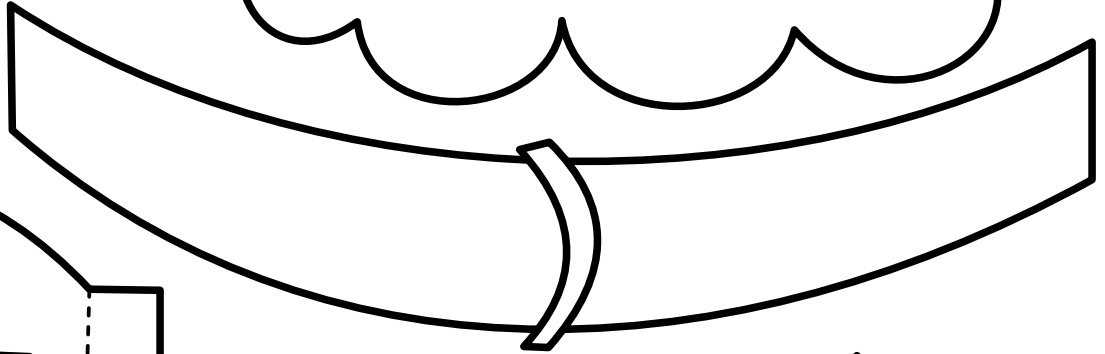
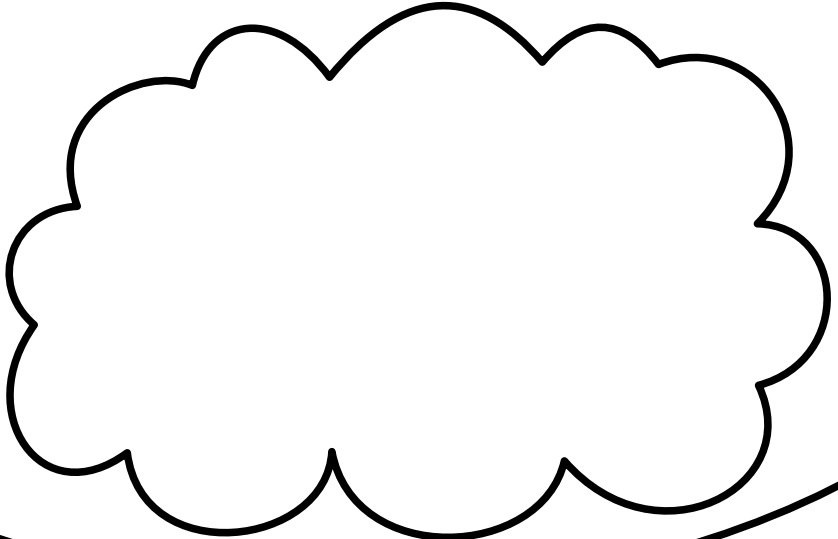

collar

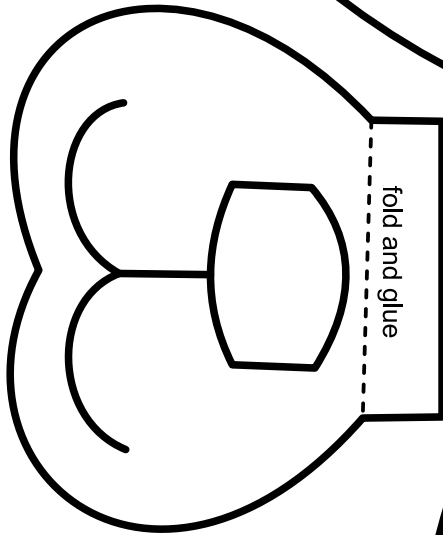

muzzle

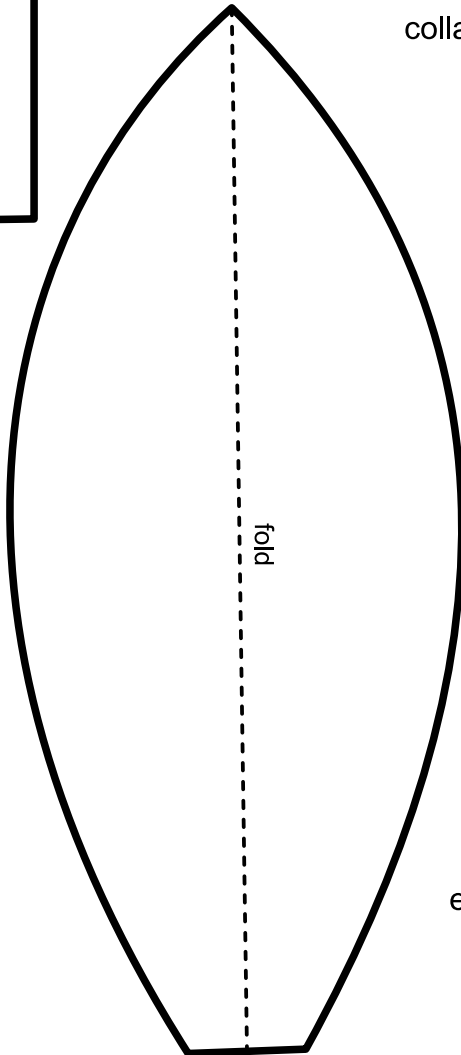

fold

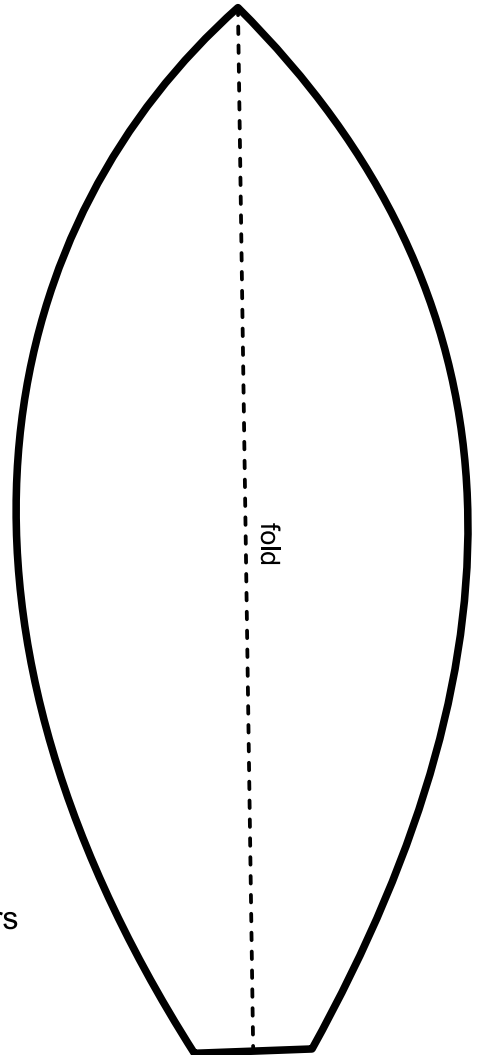

fold

ears

LION

MATERIALS

- letter sized yellow construction paper (for base puppet)
- patterns (p. 257)
- markers or crayons
- scissors
- glue

INSTRUCTIONS

1. Make the basic puppet from the construction paper.
2. Color the pattern pieces and cut out.
3. Glue the pattern pieces onto the basic puppet. (see example)
4. Draw eyes with crayons or markers.

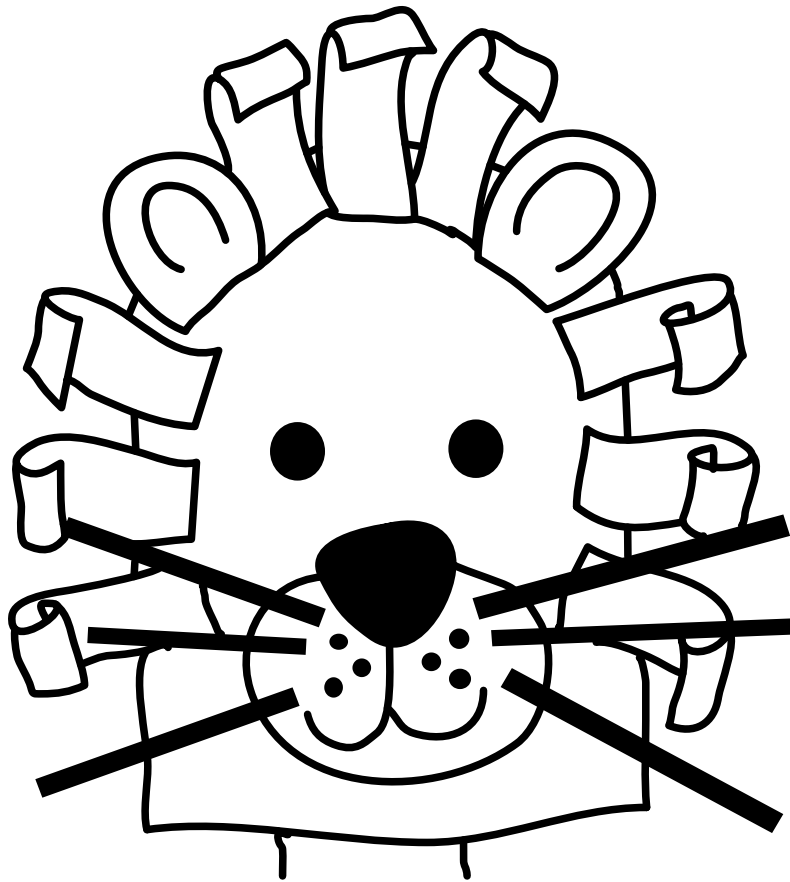

LION PUPPET PATTERNS

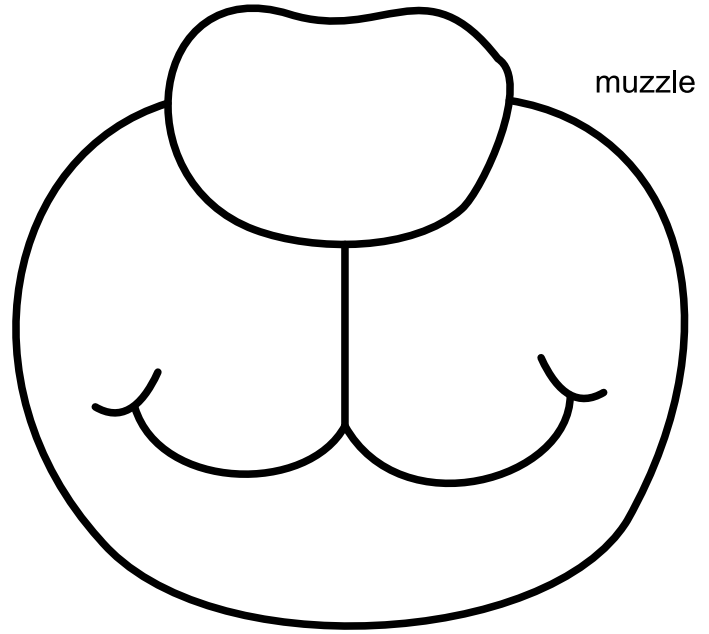
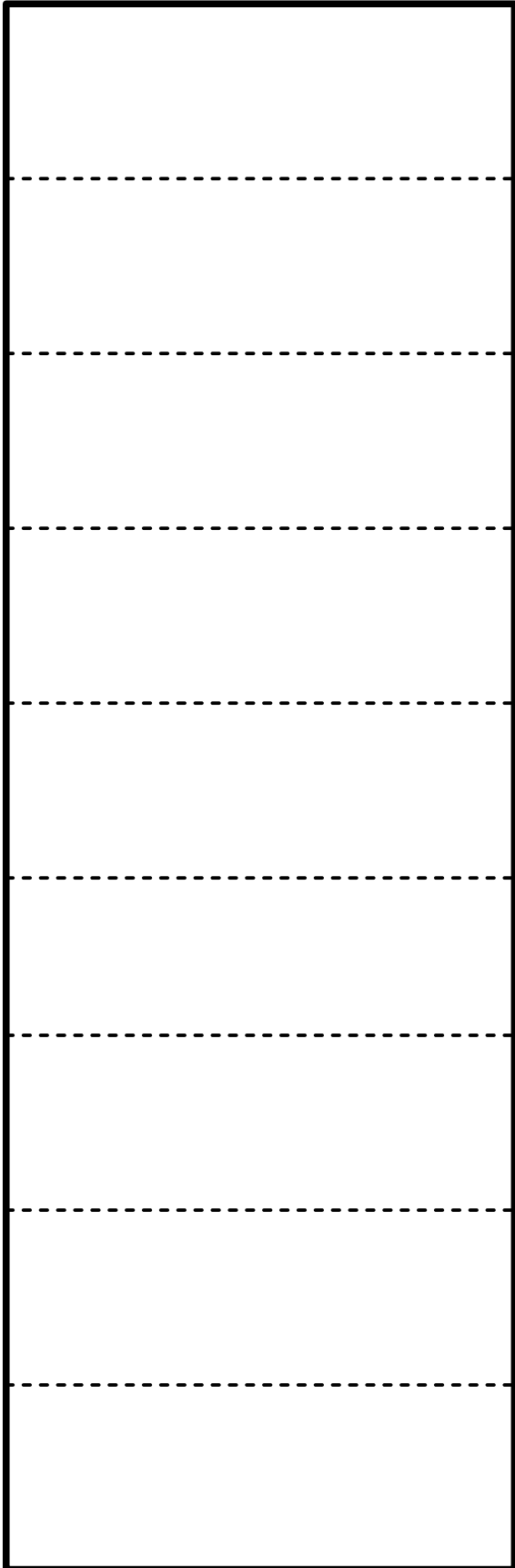

muzzle

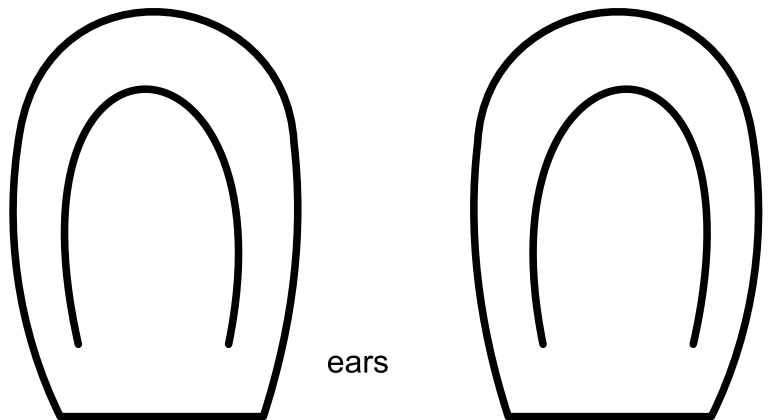

ears

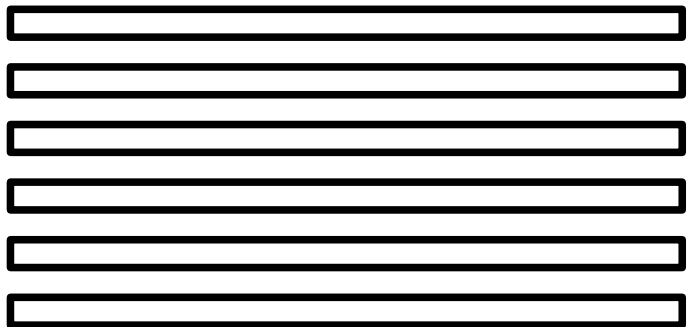

whiskers

mane
curl on a pencil

MONKEY

MATERIALS

- letter sized brown construction paper (for base puppet)
- patterns (p. 259)
- markers or crayons
- scissors
- glue

INSTRUCTIONS

1. Make the basic puppet from the construction paper.
2. Color the pattern pieces and cut out.
3. Glue the pattern pieces onto the basic puppet. (see example)

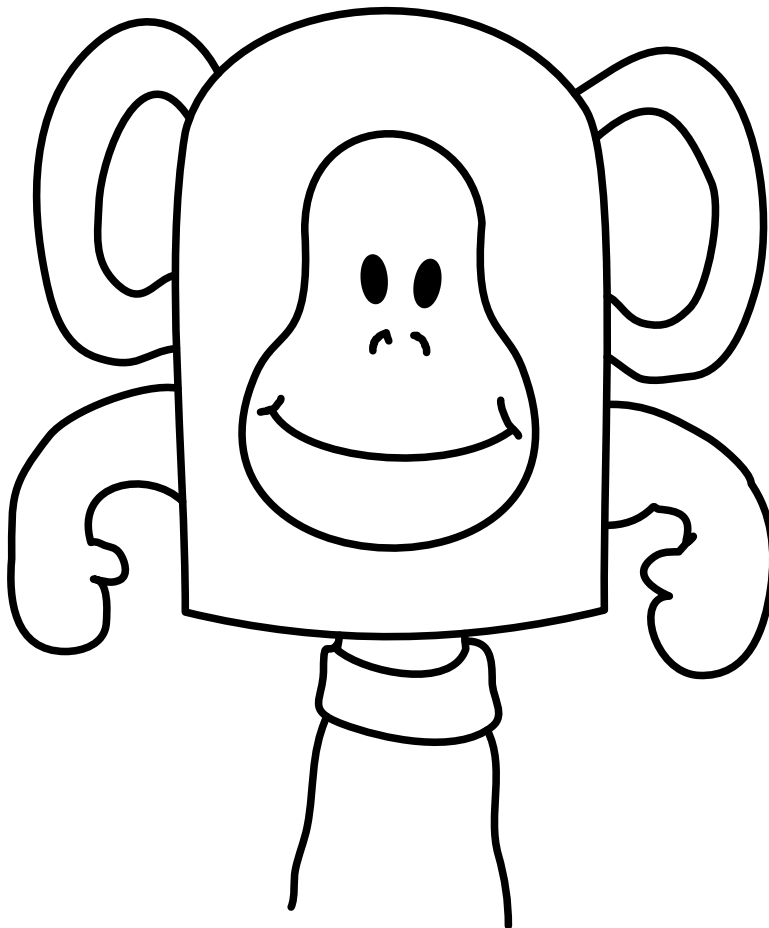

MONKEY PUPPET PATTERNS

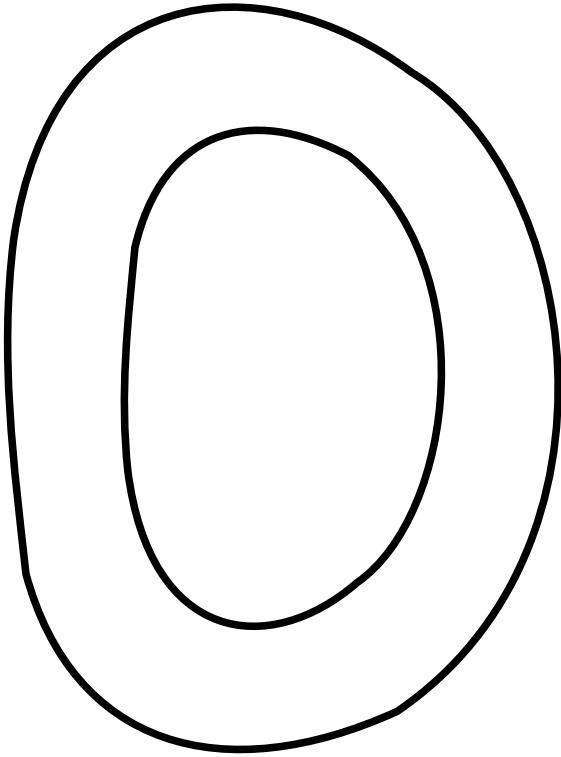

ears

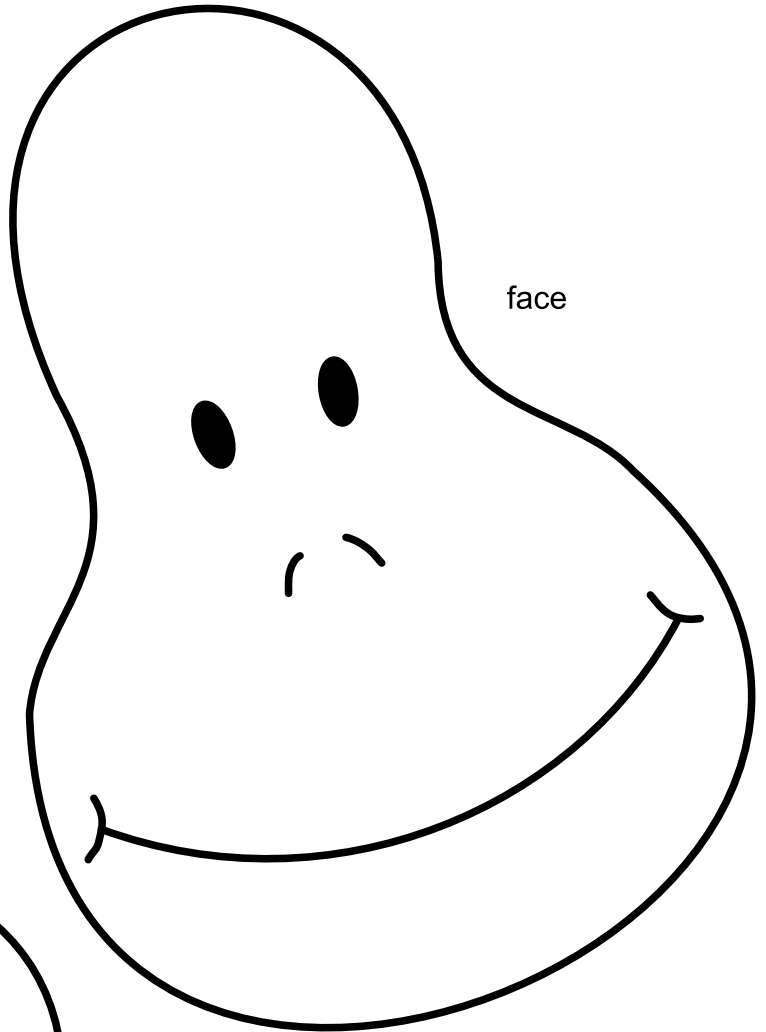

face

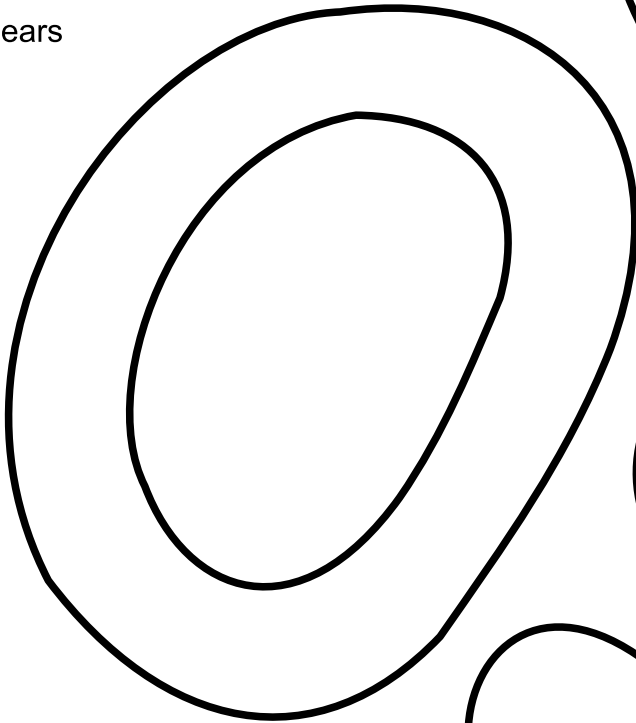

arms

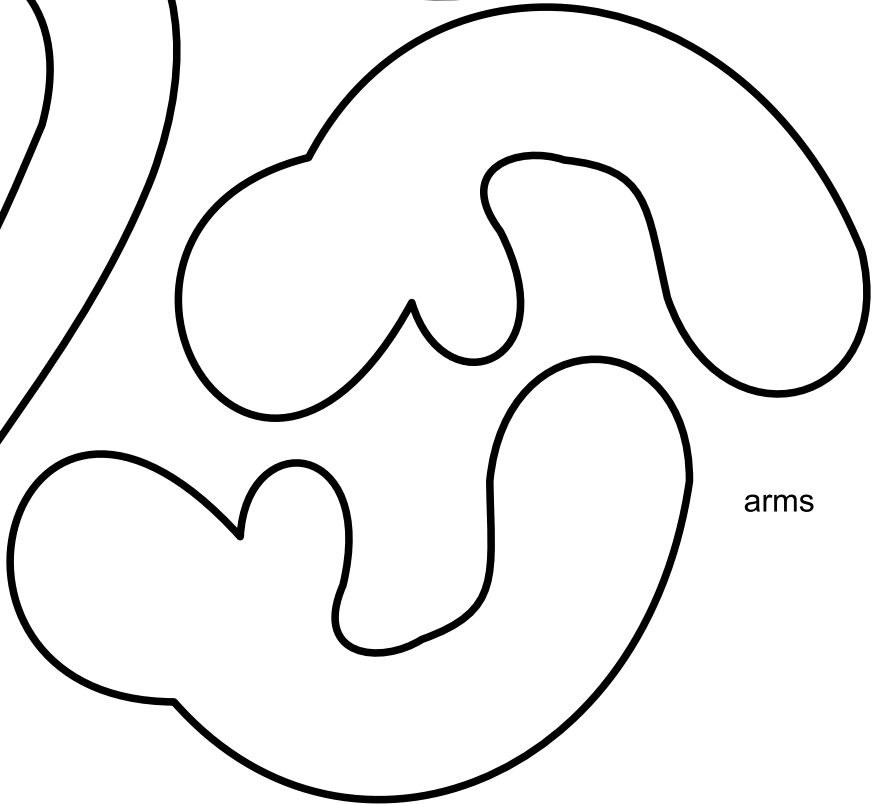

MOUSE

MATERIALS

- letter sized gray construction paper (for base puppet)
- patterns (p. 261)
- markers or crayons
- scissors
- glue

INSTRUCTIONS

1. Make the basic puppet from the construction paper.
2. Color the pattern pieces and cut out.
3. Glue the pattern pieces onto the basic puppet. (see example)
4. Draw eyes with crayons or markers.

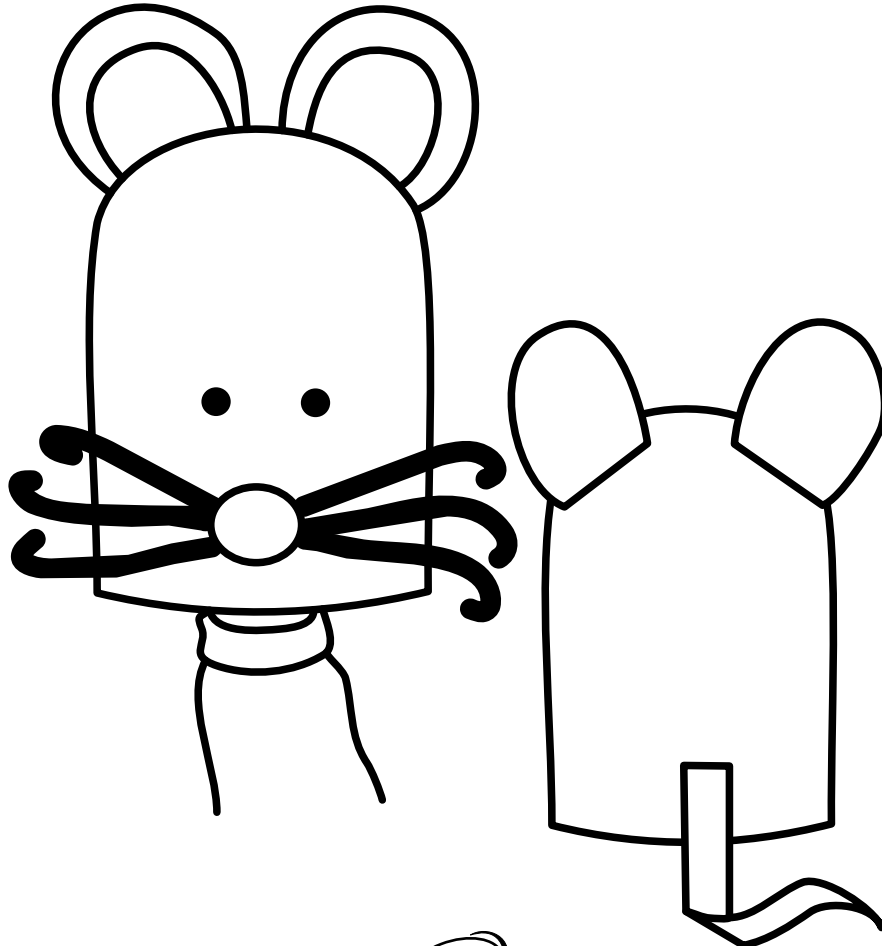

MOUSE PUPPET PATTERNS

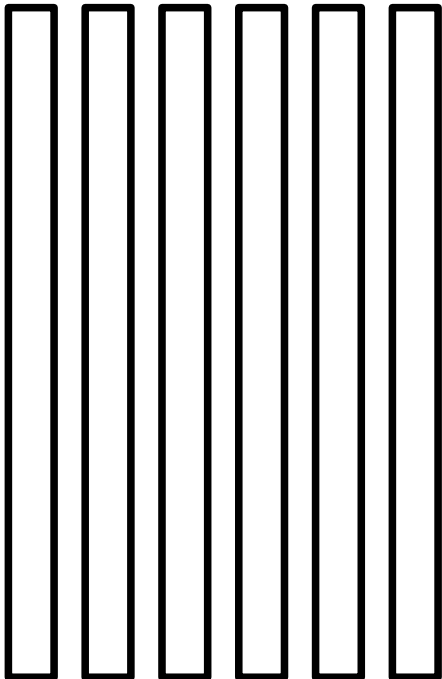

whiskers
Curl on a pencil

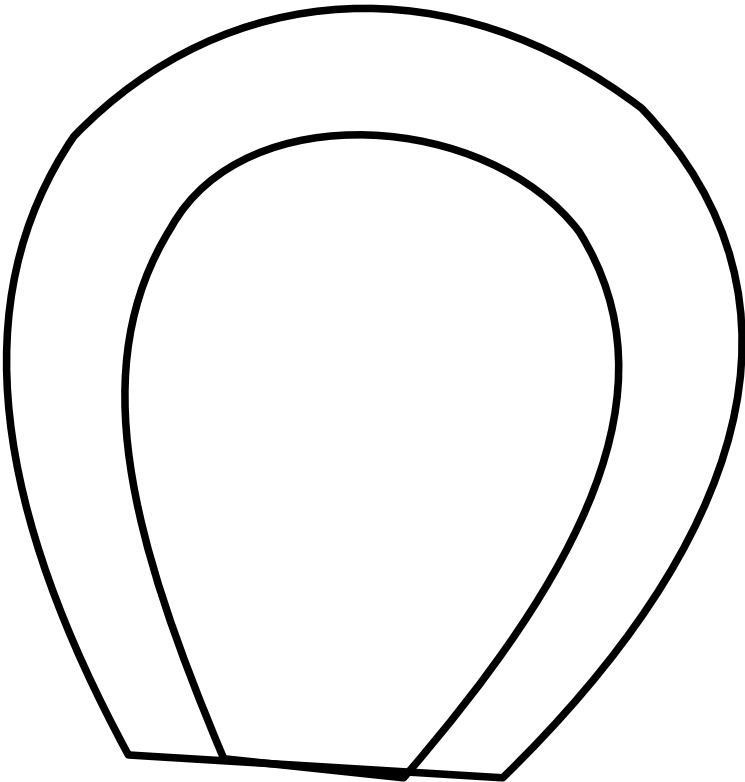

ears

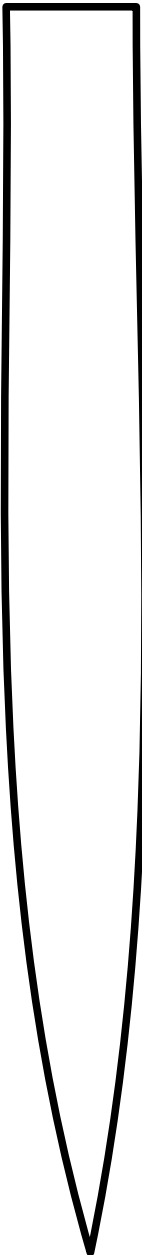

tail

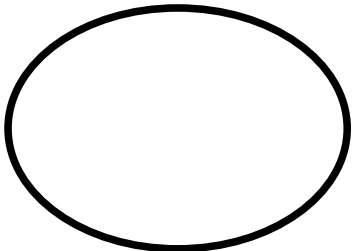

nose

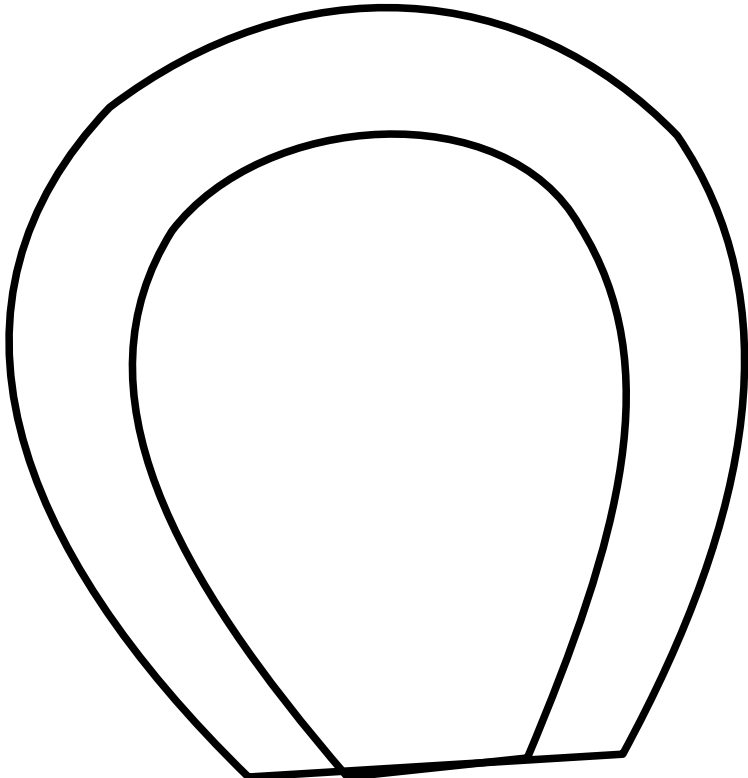

OCTOPUS

MATERIALS

- letter sized light pink construction paper (for base puppet)
- patterns (p. 263)
- markers or crayons
- scissors
- glue

INSTRUCTIONS

1. Make the basic puppet from the construction paper.
2. Color the pattern pieces and cut out.
3. Glue the pattern pieces onto the basic puppet. (see example)
4. Draw a mouth with crayons or markers.

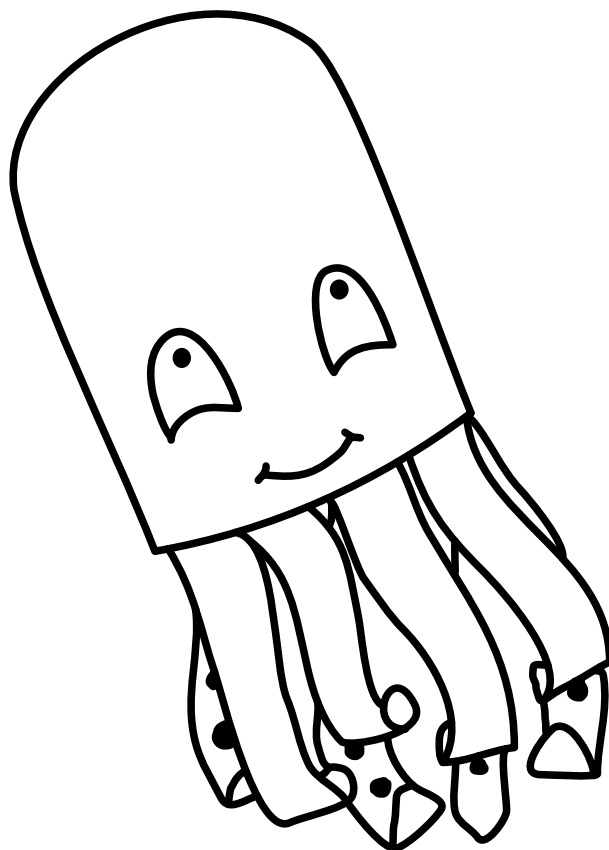

OCTOPUS PUPPET PATTERNS

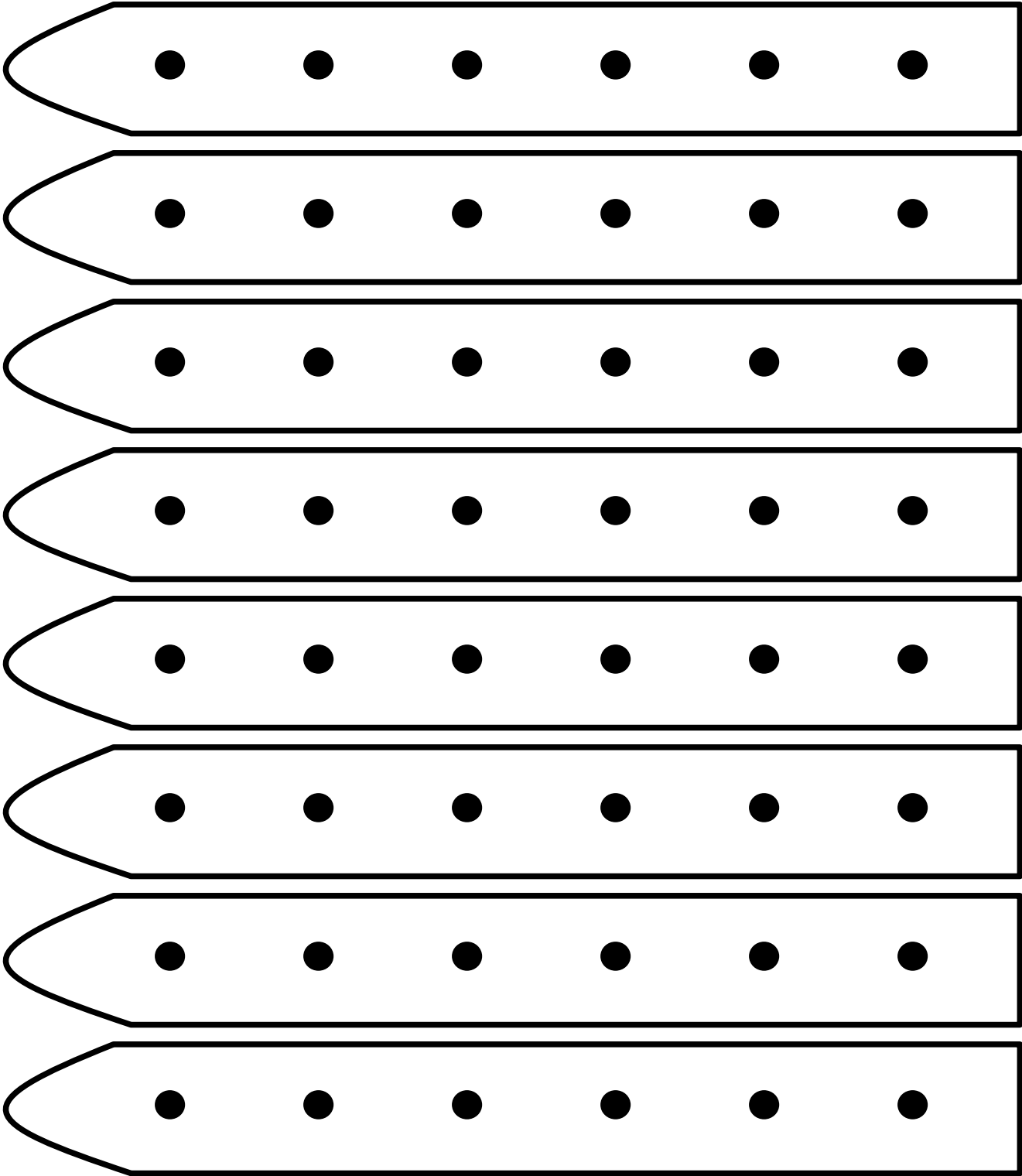

eyes

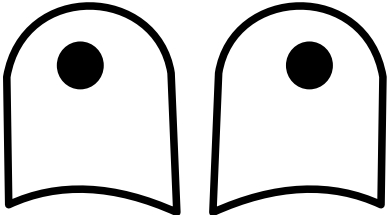

tentacles

PIG

MATERIALS

- letter sized light gray construction paper (for base puppet)
- patterns (p. 265)
- markers or crayons
- scissors
- glue

INSTRUCTIONS

1. Make the basic puppet from the construction paper.
2. Color the pattern pieces and cut out.
3. Glue the pattern pieces onto the basic puppet. (see example)
4. Draw eyes with crayons or markers.

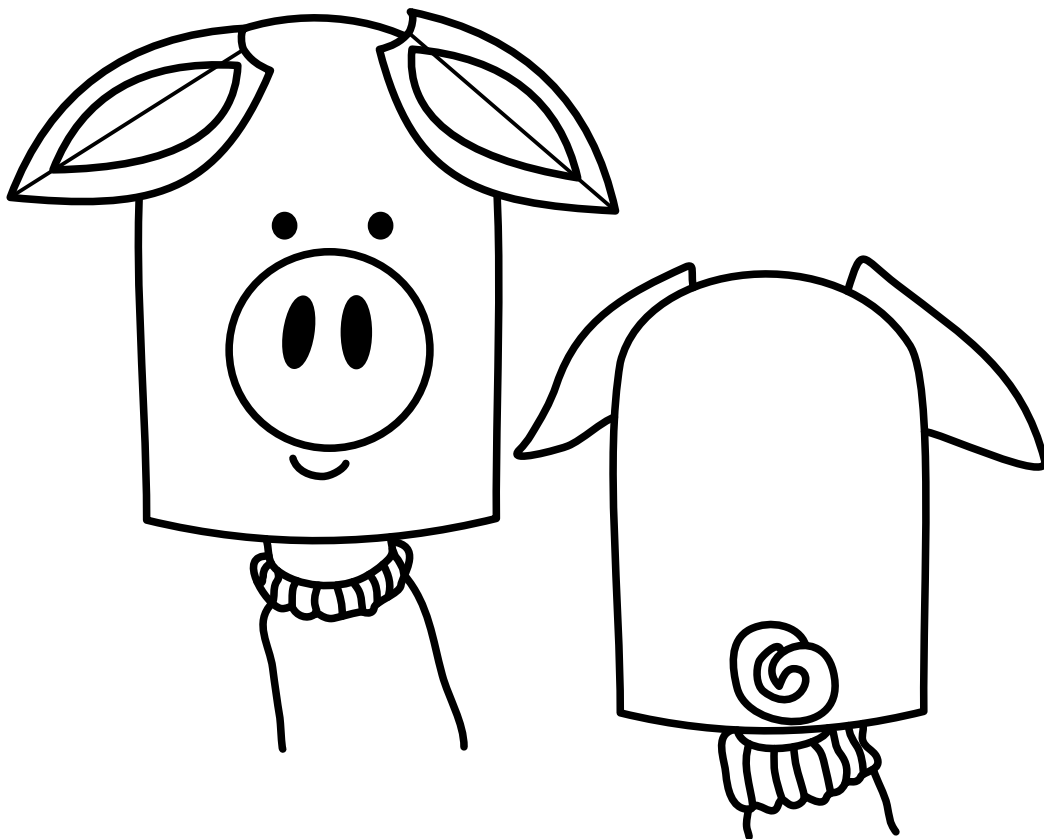

PIG PUPPET PATTERNS

tail

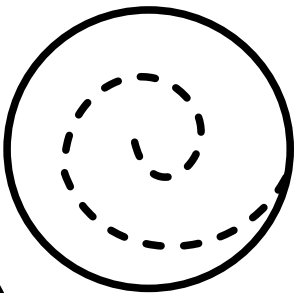

(CUT ALONG THE DOTTED LINE)

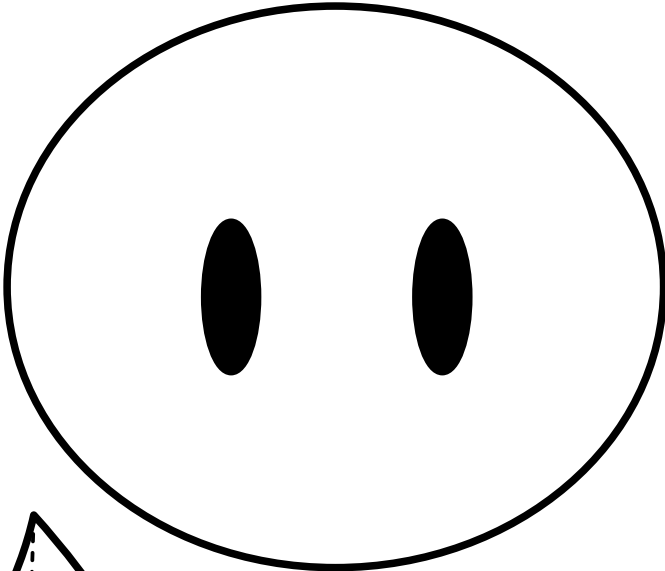

snout

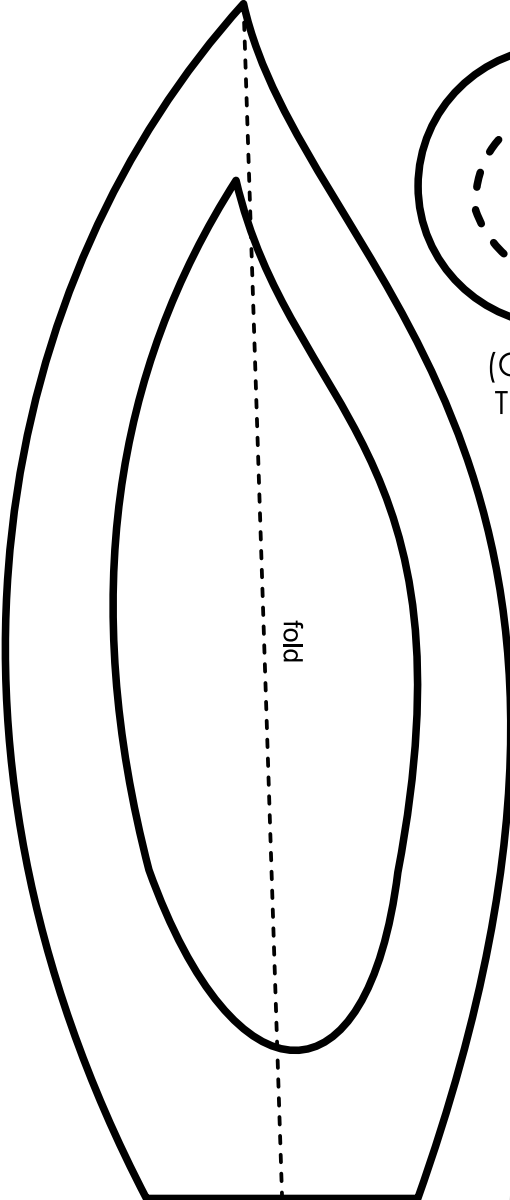

fold

ears

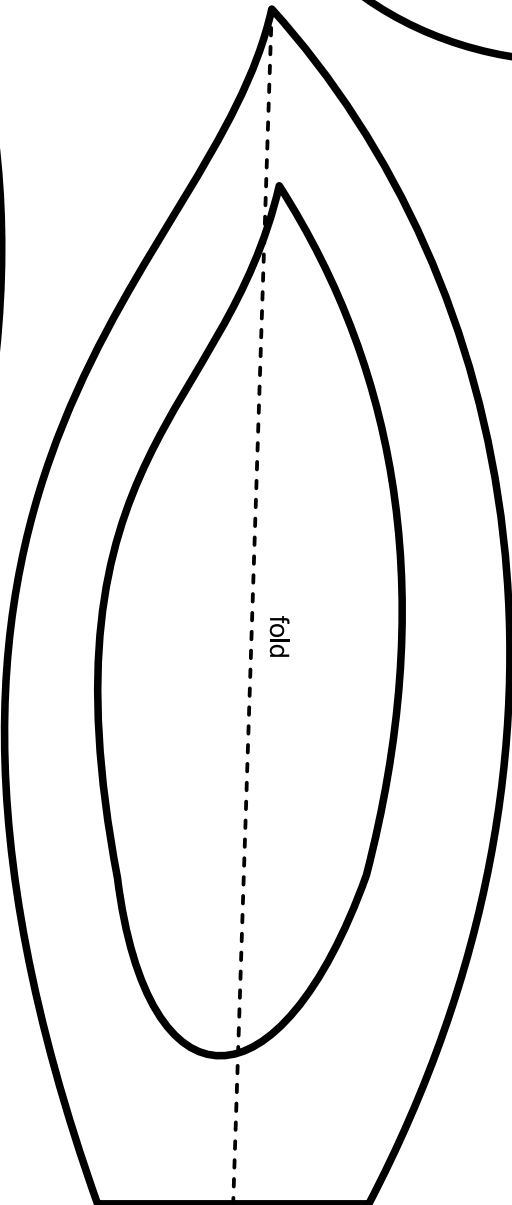

fold

PRINCESS

MATERIALS

- letter sized tan construction paper (for base puppet)
- patterns (p. 267)
- markers or crayons
- scissors
- glue
- lace strip (optional)

INSTRUCTIONS

1. Make the basic puppet from the construction paper.
2. Color the pattern pieces and cut out.
3. Glue the pattern pieces onto the basic puppet. (see example)
4. Draw eyes, a nose, mouth and other details with crayons or markers.

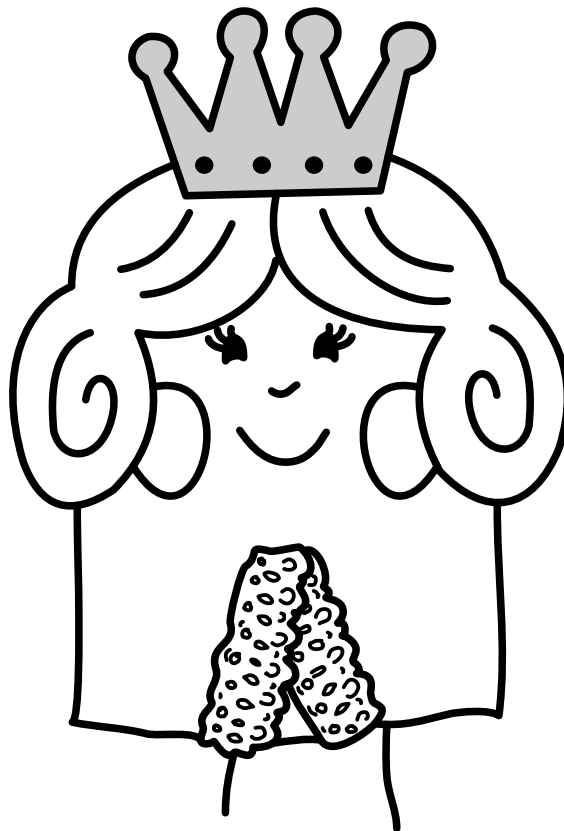

cheeks

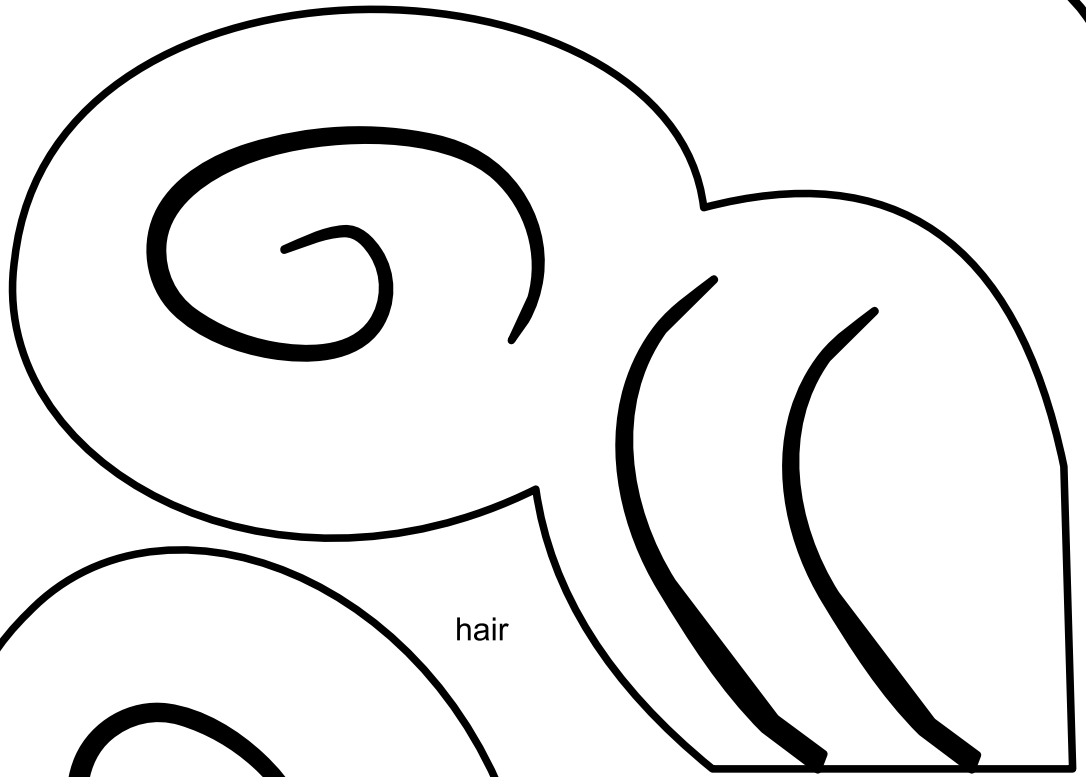
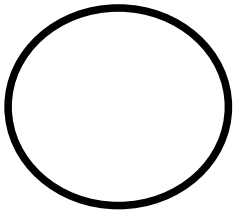
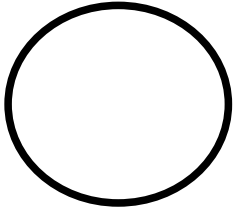

hair

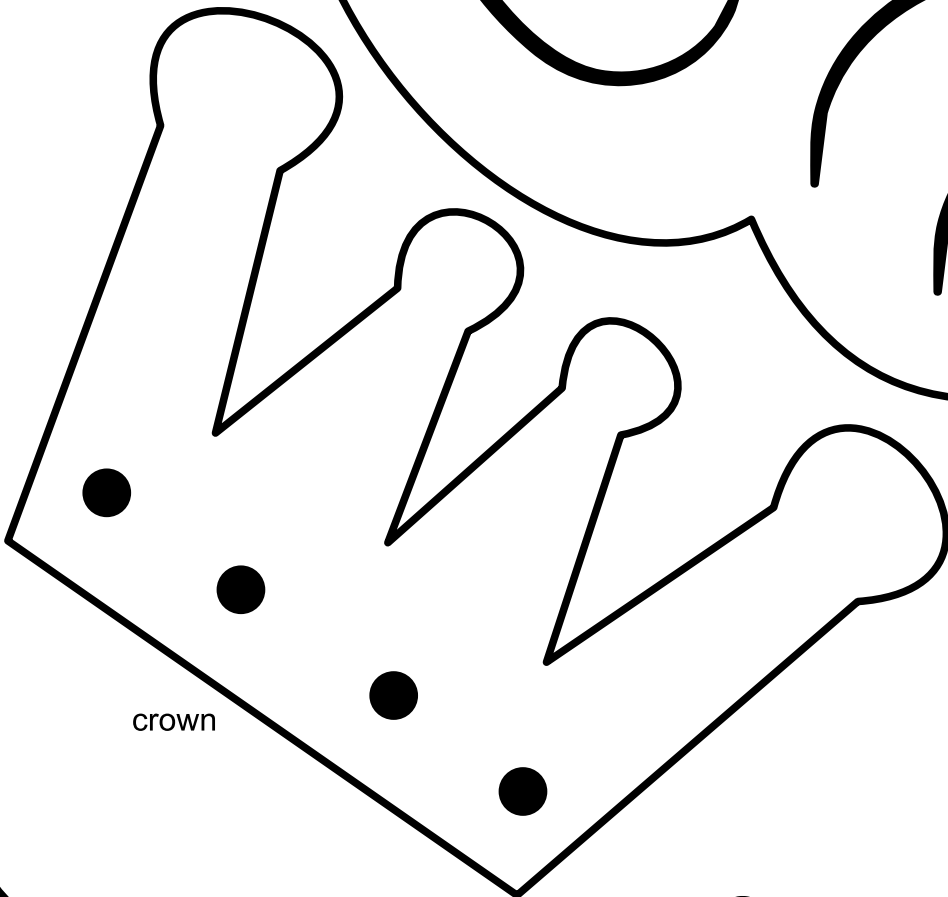

crown

RACCOON

MATERIALS

- letter sized gray construction paper (for base puppet)
- patterns (p. 269)
- markers or crayons
- scissors
- glue

INSTRUCTIONS

1. Make the basic puppet from the construction paper.
2. Color the pattern pieces and cut out.
3. Glue the pattern pieces onto the basic puppet. (see example)

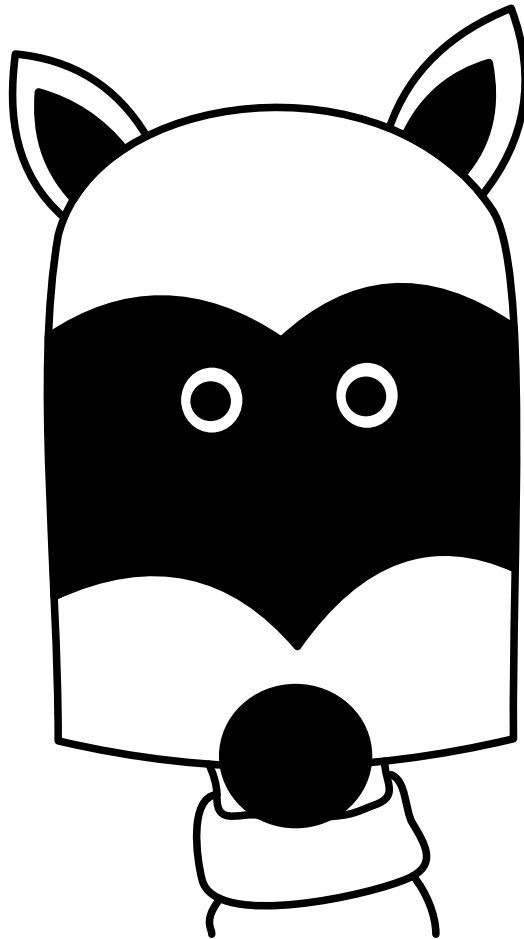

RACCOON PUPPET PATTERNS

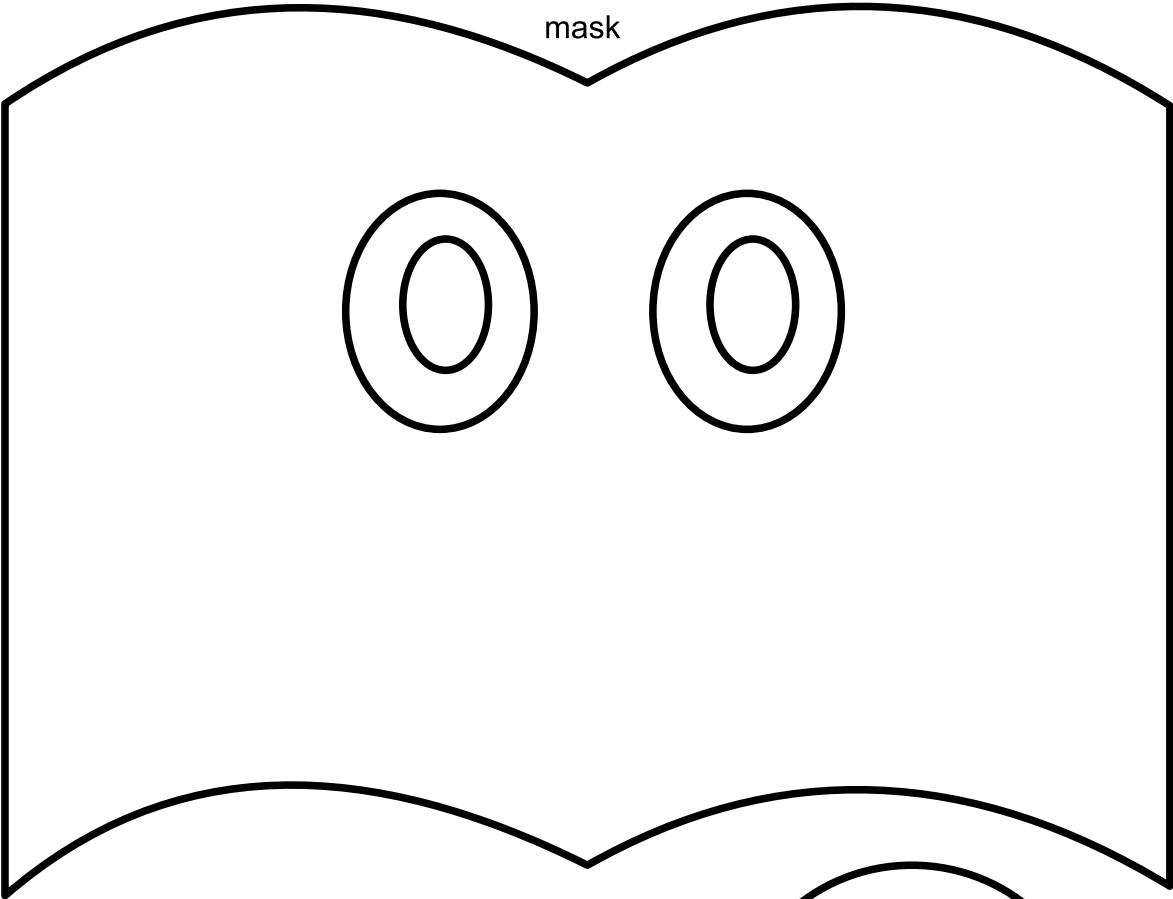

mask

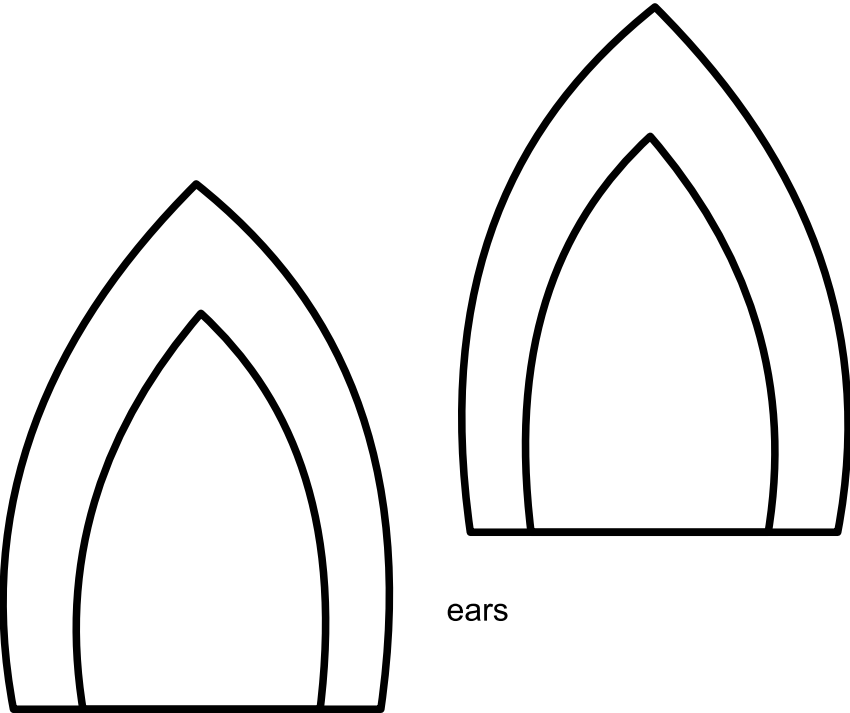

ears

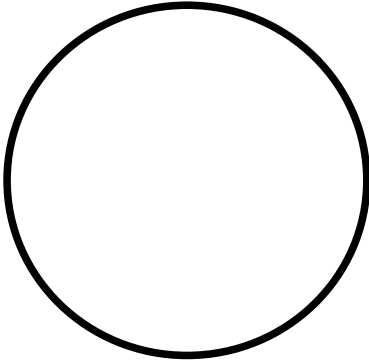

nose

ROBOT

MATERIALS

- letter sized yellow construction paper (for base puppet)
- patterns (p. 271)
- markers or crayons
- scissors
- glue

INSTRUCTIONS

1. Make the basic puppet from the construction paper.
2. Color the pattern pieces and cut out.
3. Glue the pattern pieces onto the basic puppet. (see example)
4. Draw details with crayons or markers.

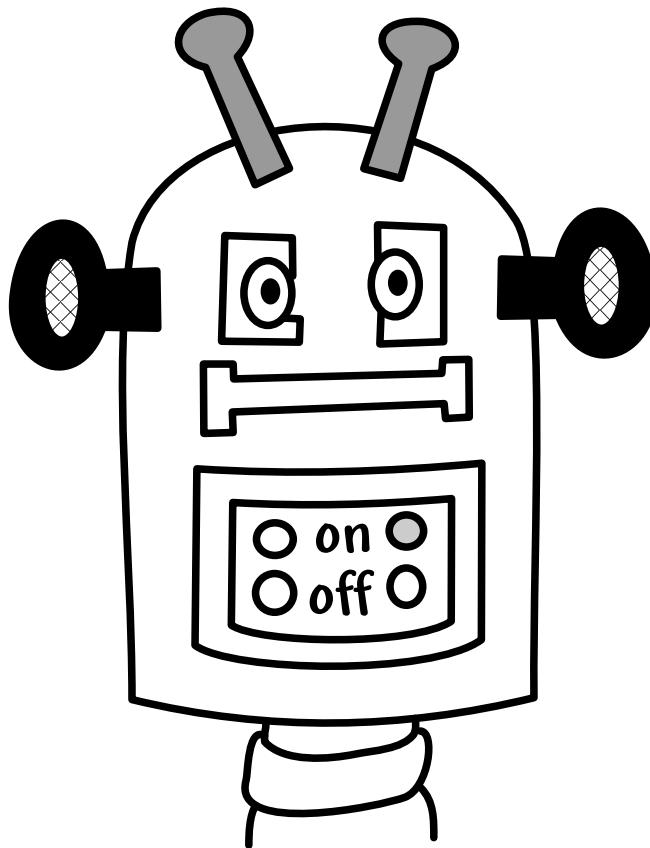

ROBOT PUPPET PATTERNS

eyes

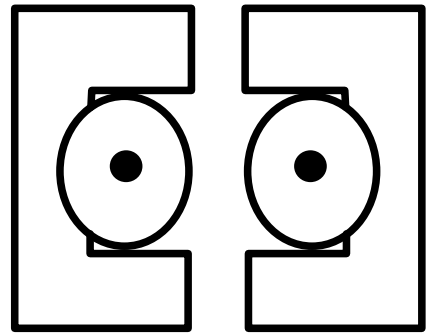

earpieces

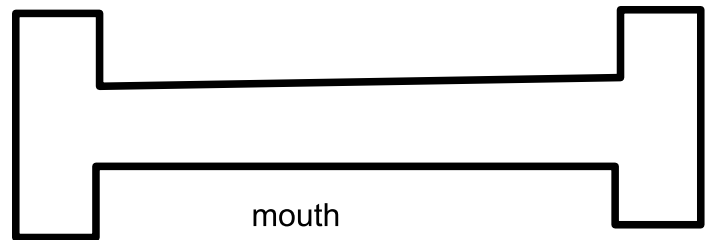
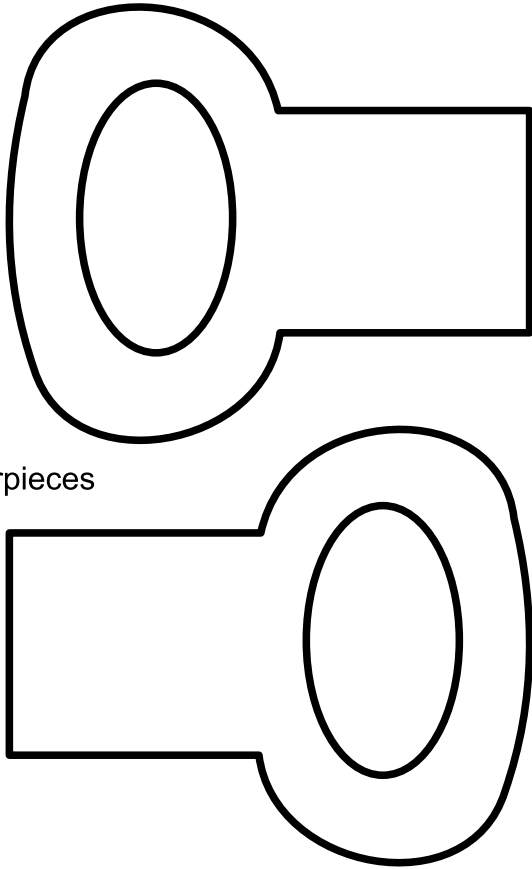

mouth

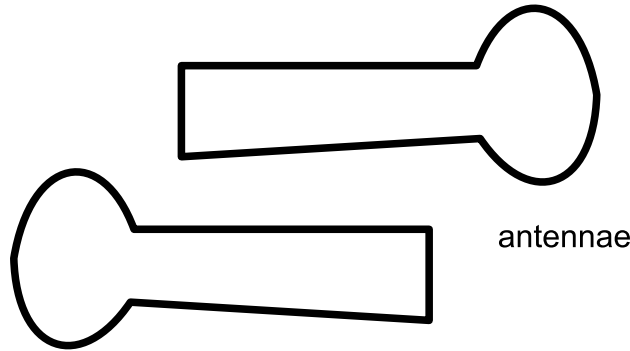

antennae

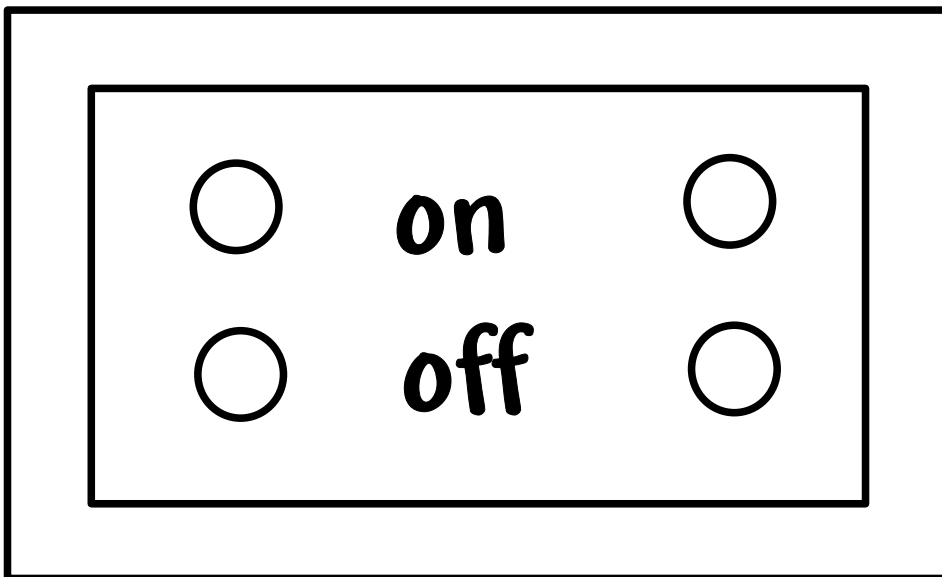

control box

SNAIL

MATERIALS

- letter sized brown construction paper (for base puppet)
- patterns (p. 273)
- markers or crayons
- scissors
- glue
- 1 mt. white yarn (cut in half)

INSTRUCTIONS

1. Make the basic puppet from the construction paper.
2. Color the pattern pieces and cut out.
3. Glue the pattern pieces onto the basic puppet. (see example)
4. Make a spiral curl of glue on the mitt. Place one piece of yarn on the glue and cut any leftover yarn. (see fig. 1) Repeat on the other side of the mitt.
5. Draw details with crayons or markers.

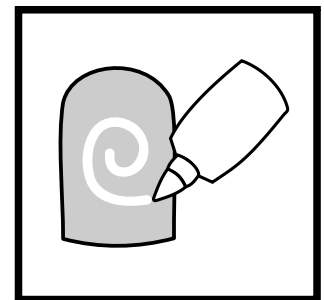
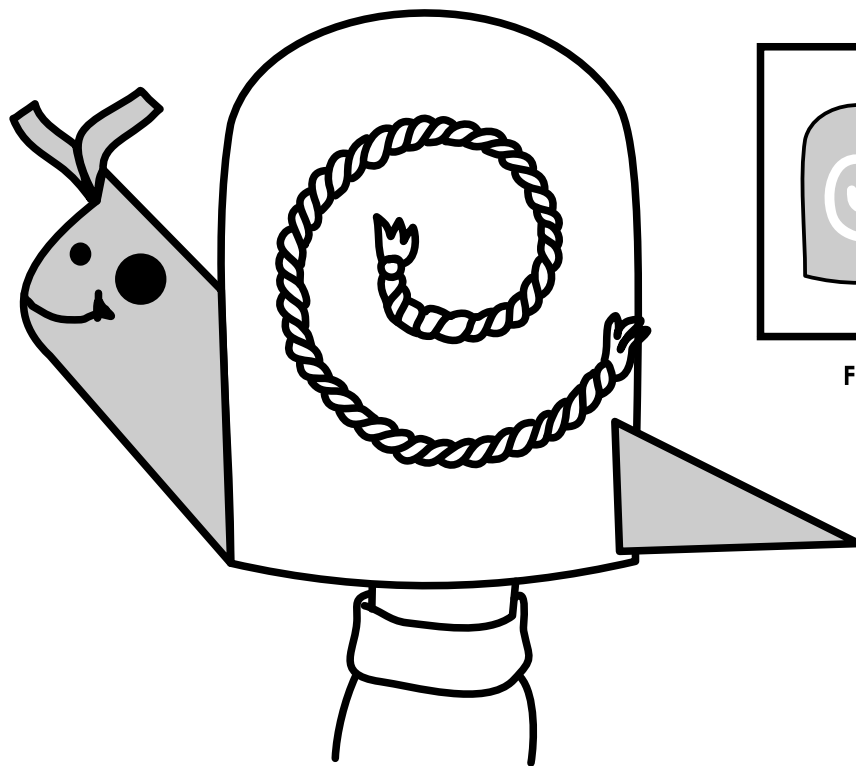

FIGURE 1

SNAIL PUPPET PATTERNS

head

fold

tail

273

PUPPETS

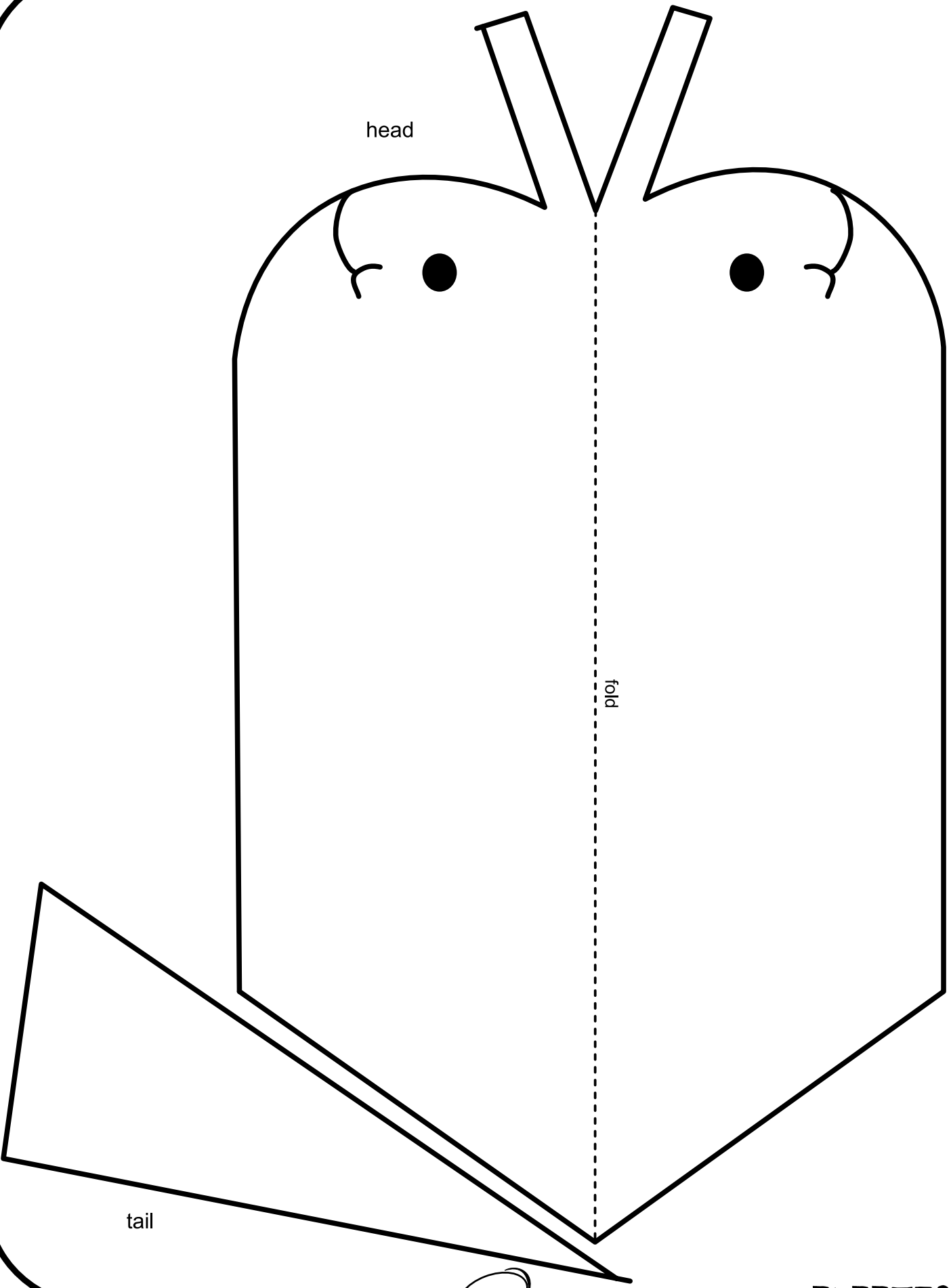

TORTOISE

MATERIALS

- letter sized brown construction paper (for base puppet)
- patterns (p. 275)
- markers or crayons
- scissors
- glue

INSTRUCTIONS

1. Make the basic puppet from the construction paper.
2. Color the pattern pieces and cut out.
3. Glue the pattern pieces onto the basic puppet. (see example)
4. Cut out the mitt pieces between the front and back feet. (see fig. 1)

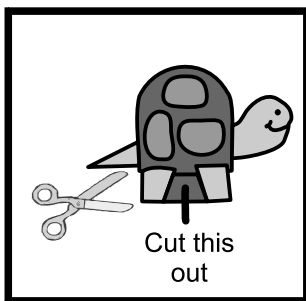
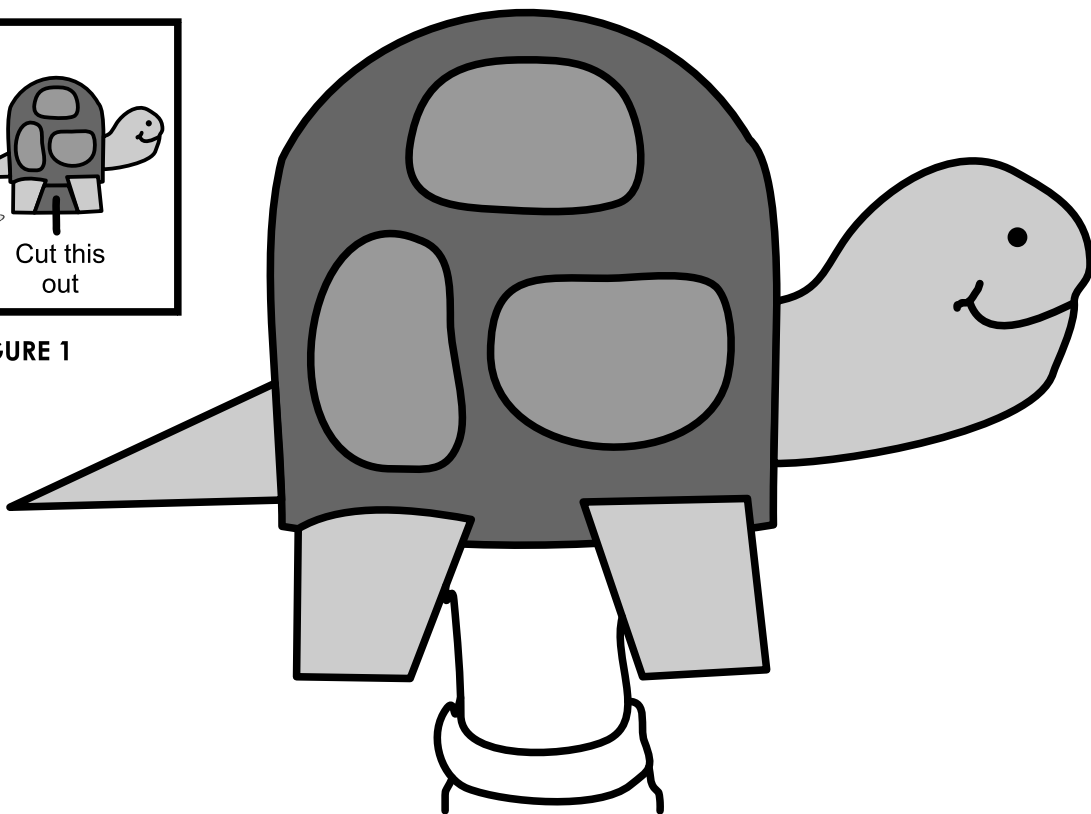
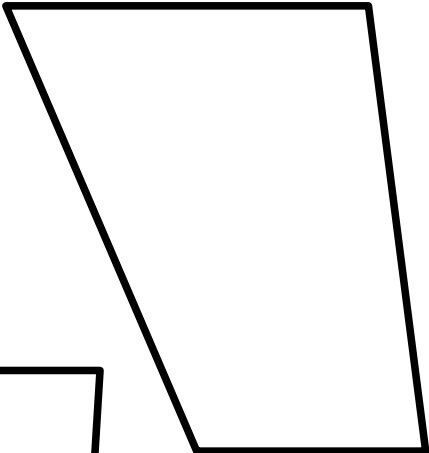

FIGURE 1



TORTOISE PUPPET PATTERNS

front leg



head

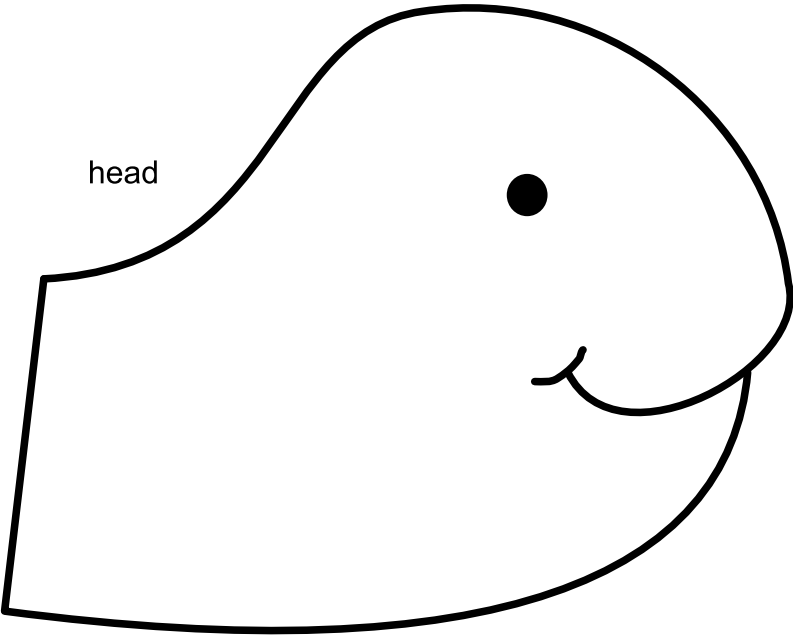

tail

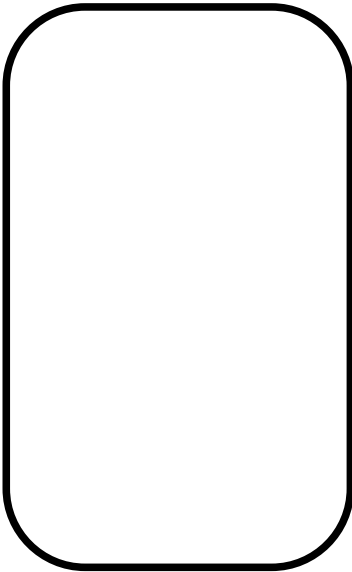
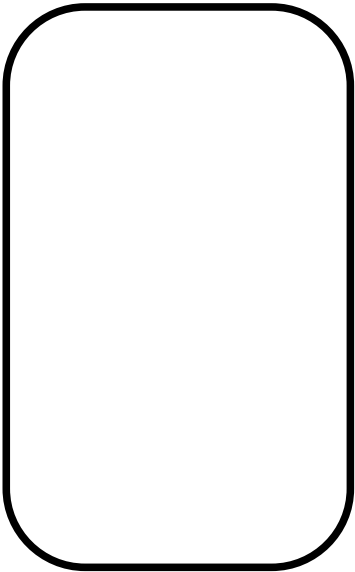
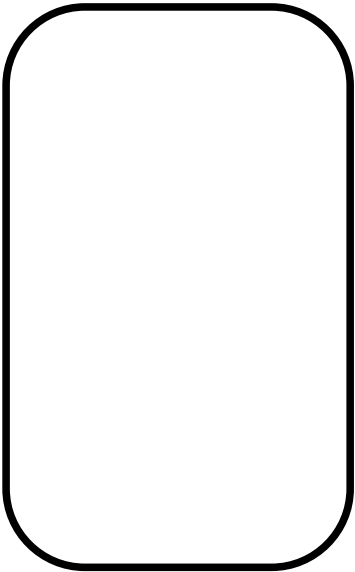
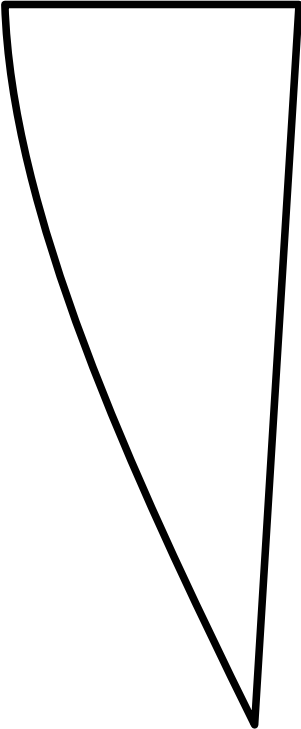

spots for the shell

back leg

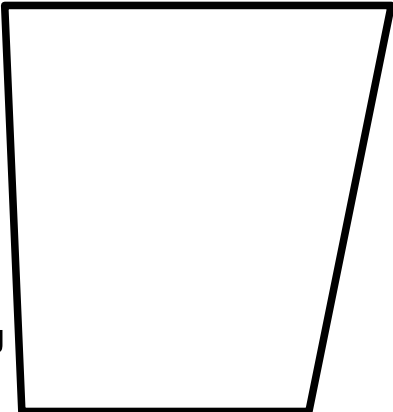

WALRUS

MATERIALS

- letter sized brown construction paper (for base puppet)
- patterns (p. 277)
- markers or crayons
- scissors
- glue

INSTRUCTIONS

1. Make the basic puppet from the construction paper.
2. Color the pattern pieces and cut out.
3. Glue the pattern pieces onto the basic puppet. (see example)
4. Draw eyes with crayons or markers.

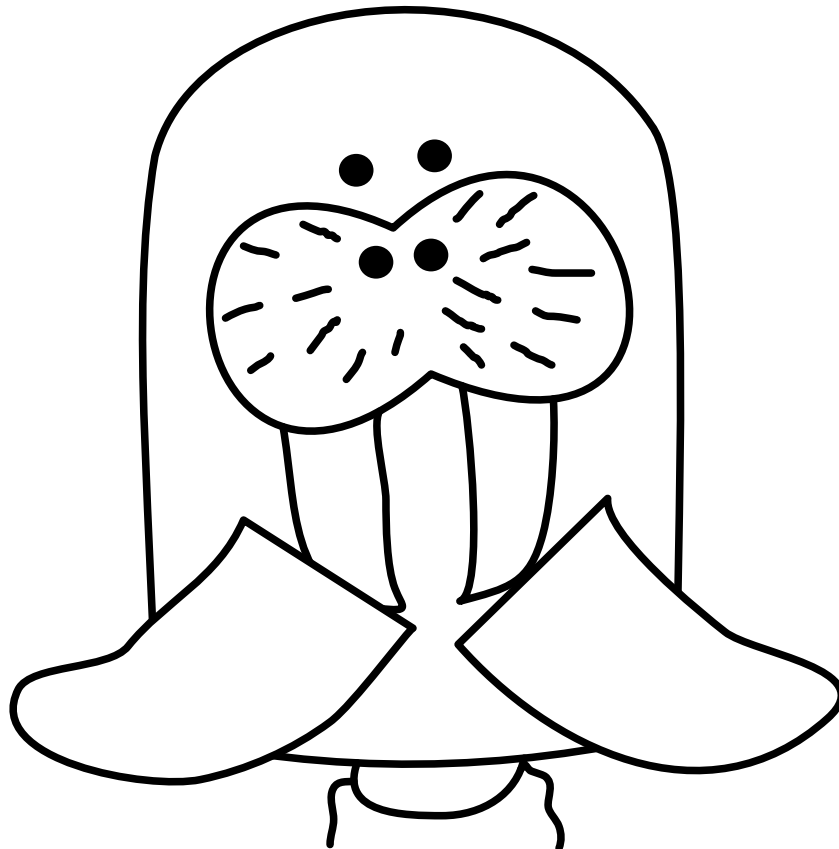

WALRUS PUPPET PATTERNS

flipper

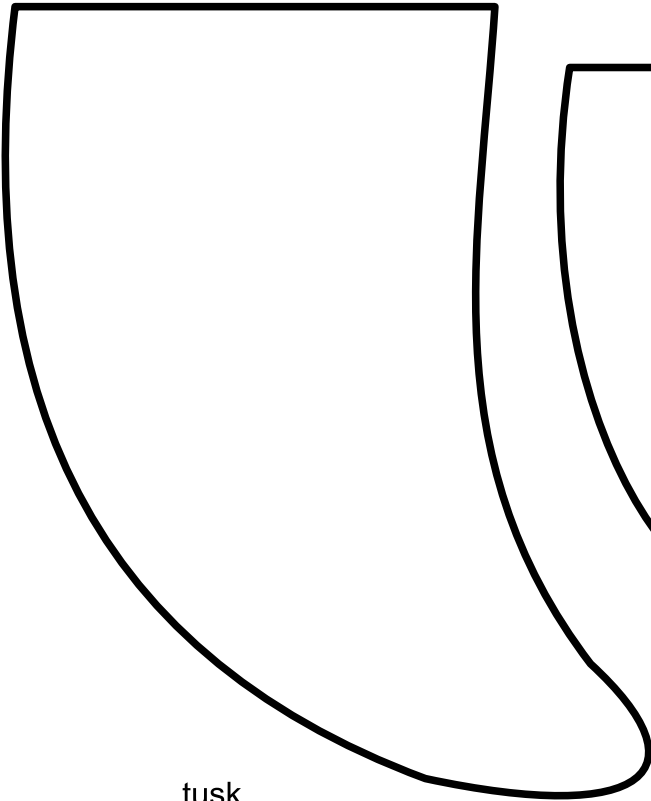

tusk

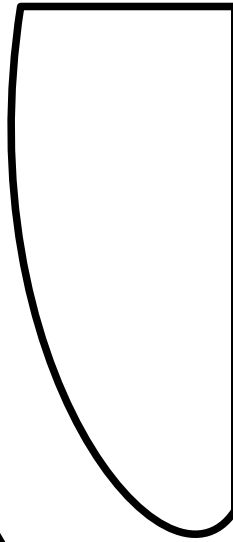

flipper



tusk

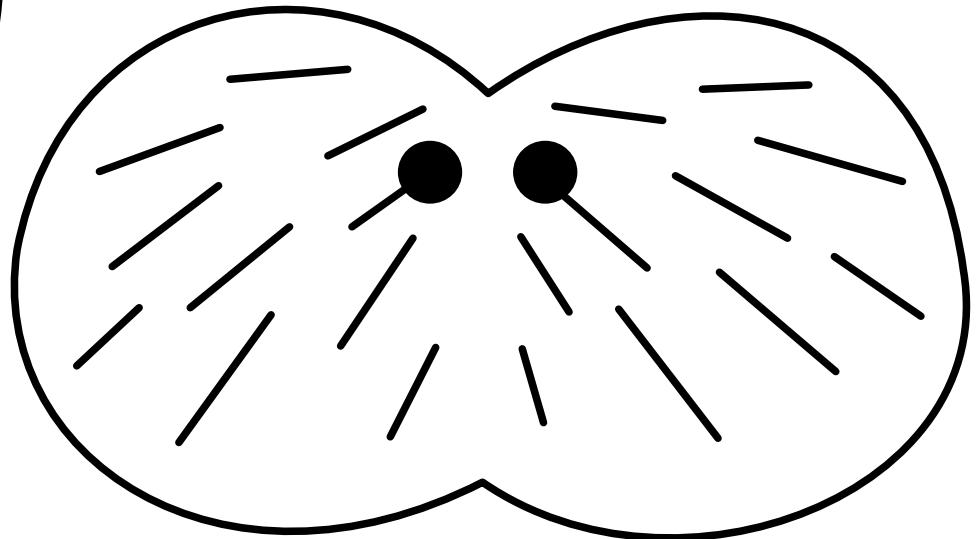
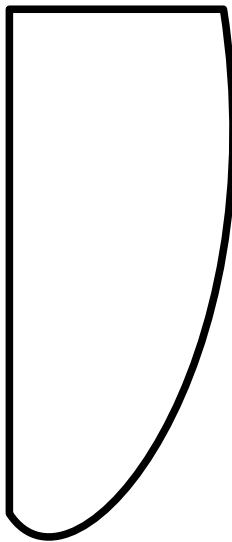

muzzle

WHALE

MATERIALS

- letter sized gray construction paper (for base puppet)
- patterns (p. 279)
- markers or crayons
- scissors
- glue

INSTRUCTIONS

1. Make the basic puppet from the construction paper.
2. Color the pattern pieces and cut out.
3. Glue the pattern pieces onto the basic puppet. (see example)
4. Draw a mouth with crayons or markers.

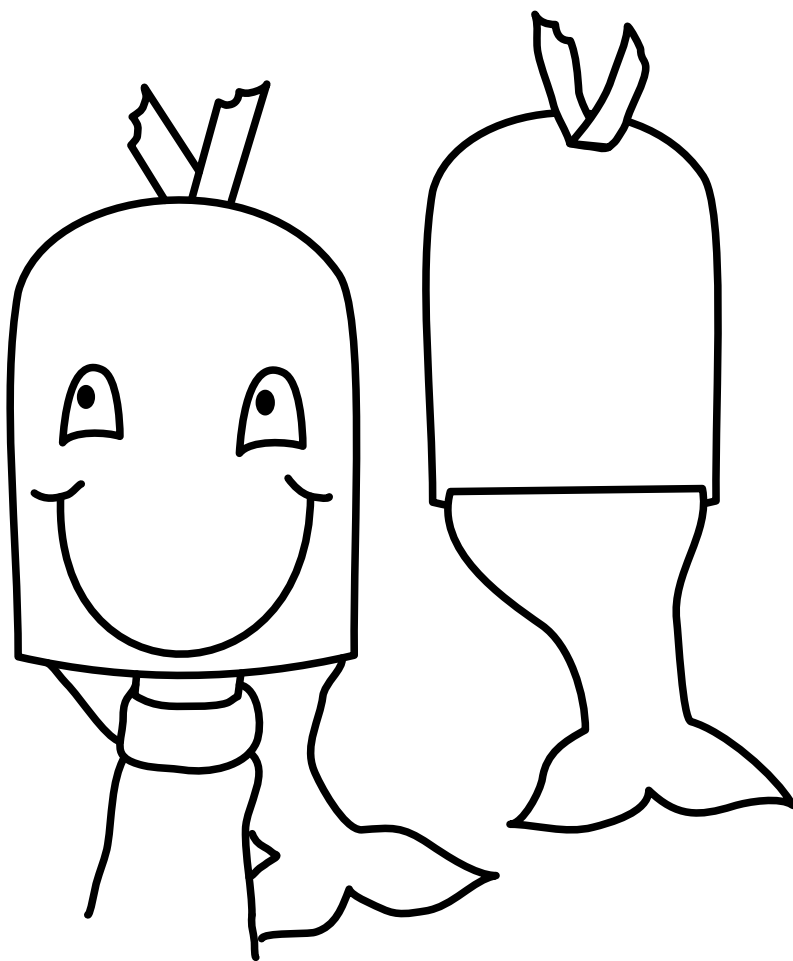

WHALE PUPPET PATTERNS

spout

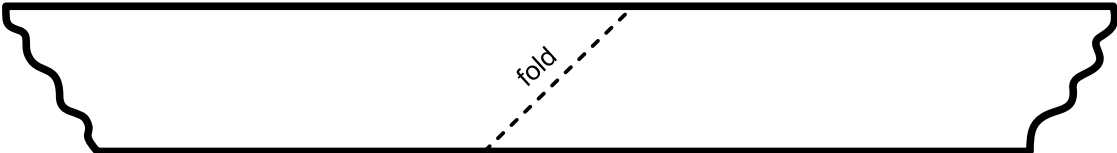

tail

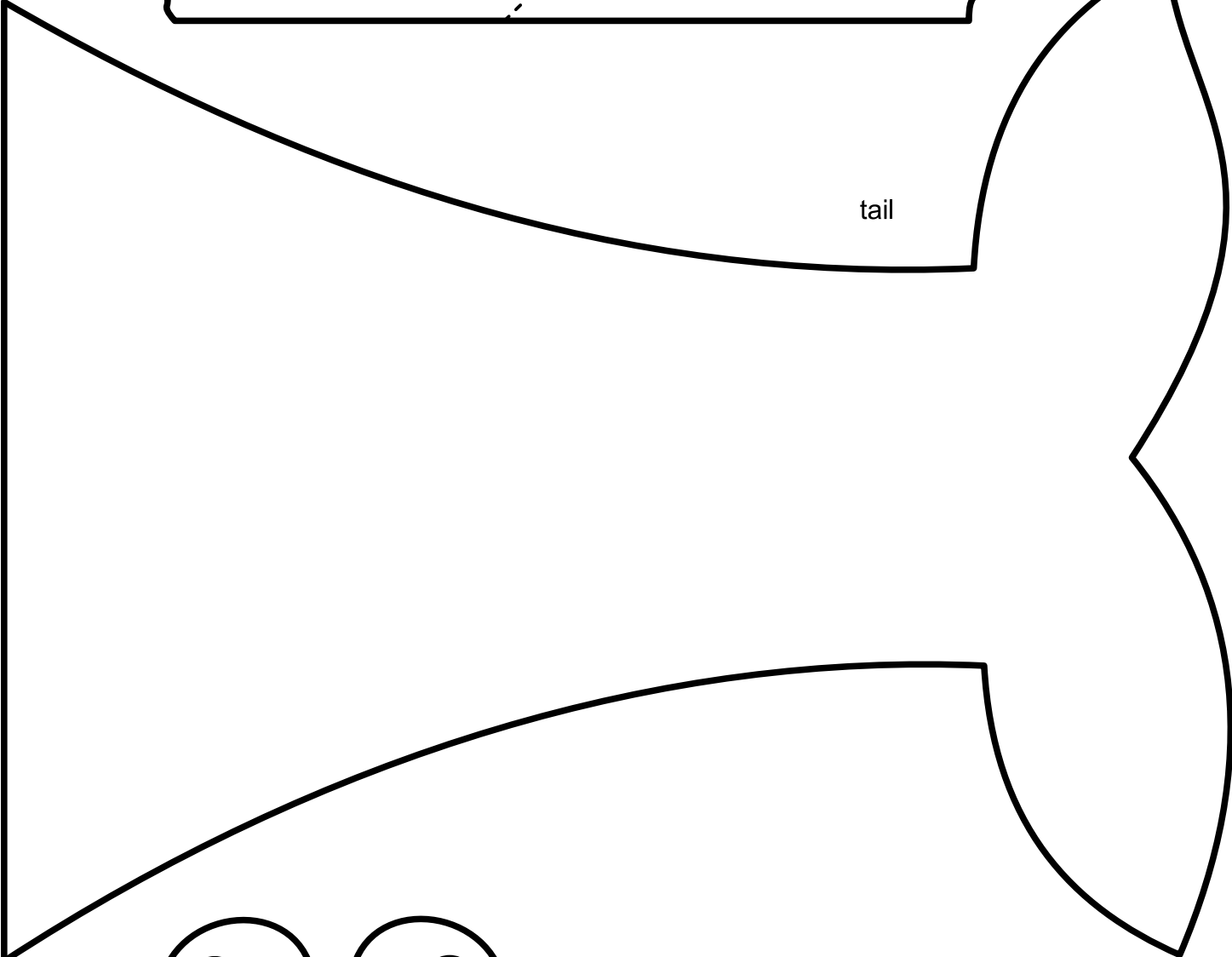

eyes

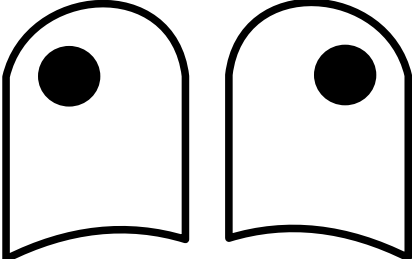

TOYS

AMBULANCE

MATERIALS

- ½ liter milk carton (clean)
- 1/4 liter milk carton (clean)
- 6 plastic soda caps
- velcro
- scissors
- red gumdrop (optional)

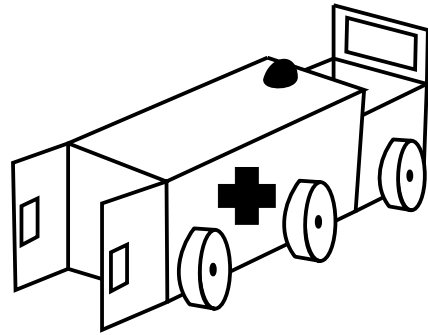

INSTRUCTIONS

1. Cut off three spout flaps from the 1/4 liter milk carton. Cut a window shape on the remaining flap and glue two soda caps on for wheels. (see fig. 1)
2. Cut off two opposite spout flaps from the ½ liter milk carton. (see fig. 2) Glue remaining soda caps on for wheels.
3. Use velcro to hold flaps closed and to attach both ambulance sections. Glue the gumdrop on top for the emergency light. (see fig. 3)

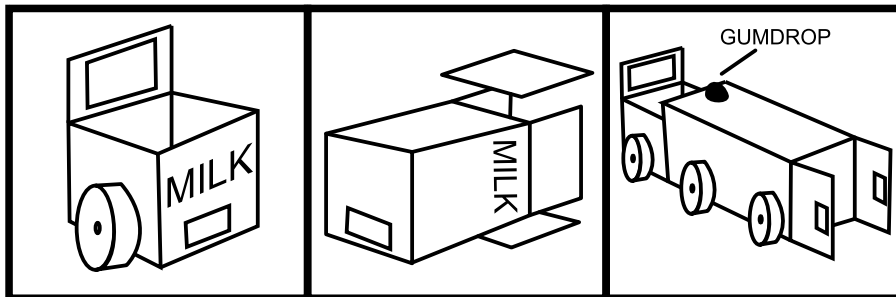

FIGURE 1

FIGURE 2

FIGURE 3

BULLDOZER

MATERIALS

- two ½ liter milk cartons (clean)
- 1/4 liter milk carton (clean)
- pasta box
- corrugated cardboard
- 4 paper fasteners
- tape
- scissors

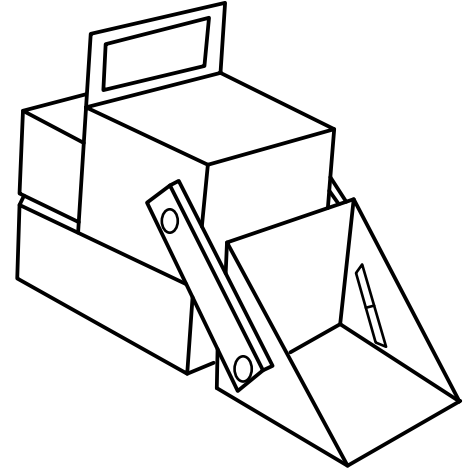

INSTRUCTIONS

1. Cut off three spout flaps from 1 ½ liter milk carton. Cut out a window shape on remaining flap. (see fig. 1)
2. Cut off spout flaps from the 1/4 liter milk carton. (see fig. 2)
3. Cut the remaining ½ liter milk carton in half diagonally to make the scoop. (see fig. 3)
4. Cut the pasta box in half. (see fig. 4)
5. Tape two strips of corrugated cardboard around one half of the pasta box. (see fig. 5)
6. Tape the ½ liter milk carton with the windshield on its side to the pasta box. Slide the 1/4 milk carton into the opening. (see fig. 6)
7. Use the paper fasteners to attach two strips of cardboard (from remaining piece of pasta box) to the sides of the ½ liter milk carton to raise and lower the scoop. (see fig. 7)

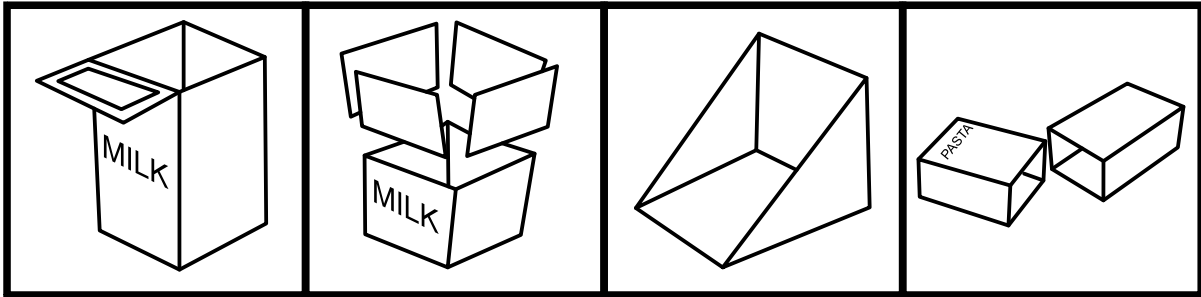

FIGURE 1

FIGURE 2

FIGURE 3

FIGURE 4

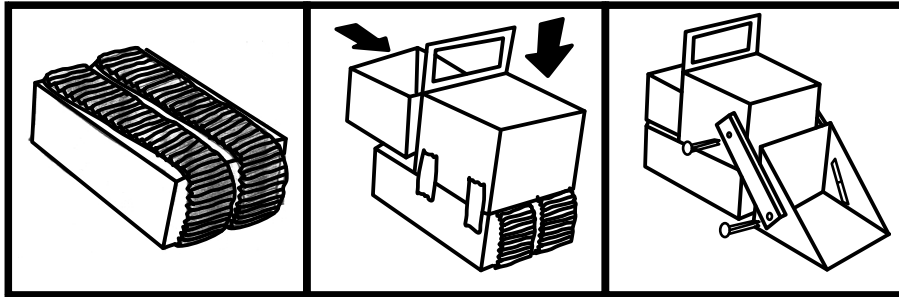

FIGURE 5

FIGURE 6

FIGURE 7

CEREAL BOX BRIDGE

MATERIALS

- large cardboard cereal box
- recycled aluminum foil
- tape
- scissors

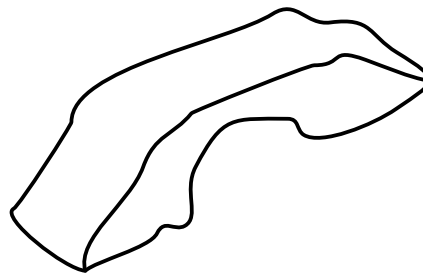

INSTRUCTIONS

1. Cut the cereal box in half the long way. Tape the ends of one half closed. (see fig. 1)
2. Cut diagonally across both corners of the half cereal box that has the ends closed. (see fig. 2)
3. Cut the short sides of the second half of the box to make flaps. (see fig. 3)
4. Tape the box corners under the flaps of the half box. Cut out a semi-circle in the center to make the arch of the bridge. (see fig. 4)
5. Wrap the bridge in aluminum foil and use tape to hold in place.

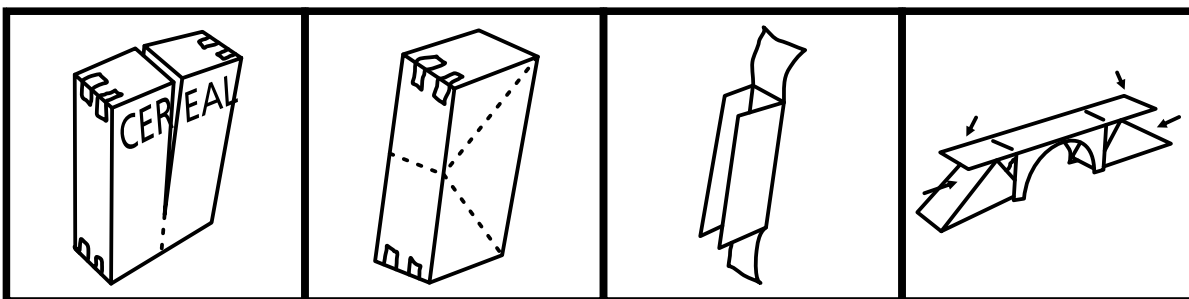

FIGURE 1

FIGURE 2

FIGURE 3

FIGURE 4

CEREAL BOX SUITCASE

MATERIALS

- medium cardboard cereal box
- cardboard (folder)
- wide ribbon
- gift wrap paper
- 2 paper fasteners
- tape
- scissors

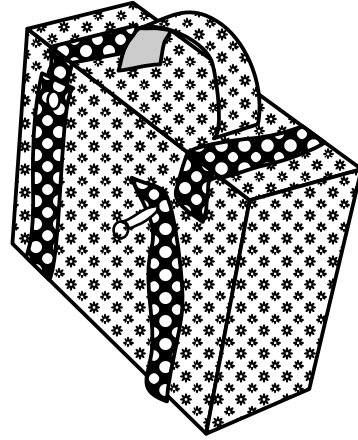

INSTRUCTIONS

1. Cut around three sides of the front panel of the cereal box. Cut two slits on the side of the box. (see fig. 1)
2. Cut out a handle from the cardboard. Cut two pieces of ribbon long enough to wrap around the box. (see fig. 2)
3. Wrap the box and handle with the gift wrap paper (wrap top flap separately to open and close). Tape in place. (see fig. 3)
4. Put the ends of the handle into the side slits and tape to hold. Wrap the ribbons around the suitcase and hold in place with the paper fasteners. (see fig. 4)

* Have the children make luggage tags for their suitcases. *

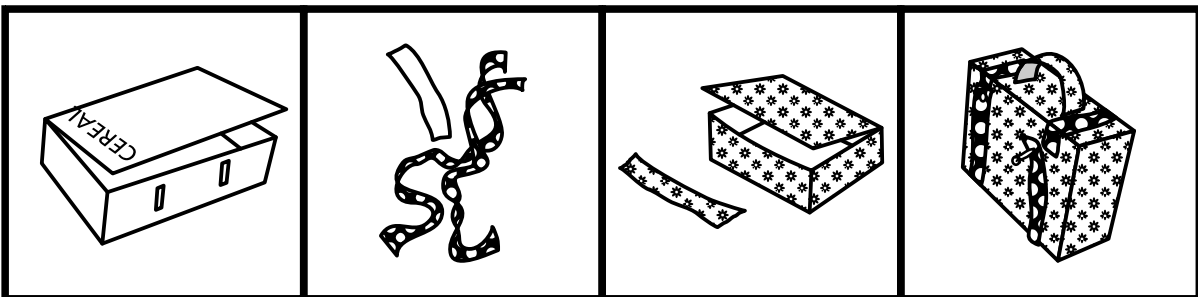

FIGURE 1

FIGURE 2

FIGURE 3

FIGURE 4

CHUBBY TURTLES

MATERIALS

- 1 empty half liter plastic container
- 1 thick plastic thread spool
- 1 plastic needle or stick
- 1 ping pong ball or similar size styrofoam ball
- cardboard
- colored adhesive tape
- clear tape
- a long piece of thin rope
- scissors
- hot glue gun

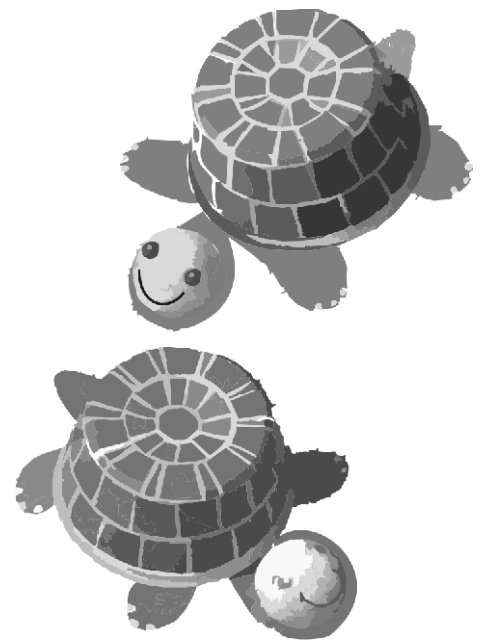

INSTRUCTIONS

1. Cut out rectangles from the colored tape and tape them on the plastic container, trying to make it look like a turtle's shell. (see example)
2. Trace a turtle shape onto the cardboard, making sure the head is bigger than the ball. (see fig. 1) Cut out.
3. Cover the cardboard turtle shape with the colored tape.
4. Cut out a rectangle in the center of the turtle shape to fit the plastic spool (horizontally). This will help the turtle roll. (see fig. 2)
5. Cut out a circle at the head so that the ball fits through. (see fig. 2)
6. Glue or draw a face onto the ball. Put it into the hole and secure it with clear tape on the bottom side.
7. Put the stick or plastic needle through the plastic spool. Place it into the rectangle and secure both ends of the stick to the cardboard with clear tape.
8. Place the turtle's shell on top and secure with clear tape from underneath.
9. Tape or glue the thin rope to the bottom of the turtle's head. Now you can pull it and it will go wherever you go!

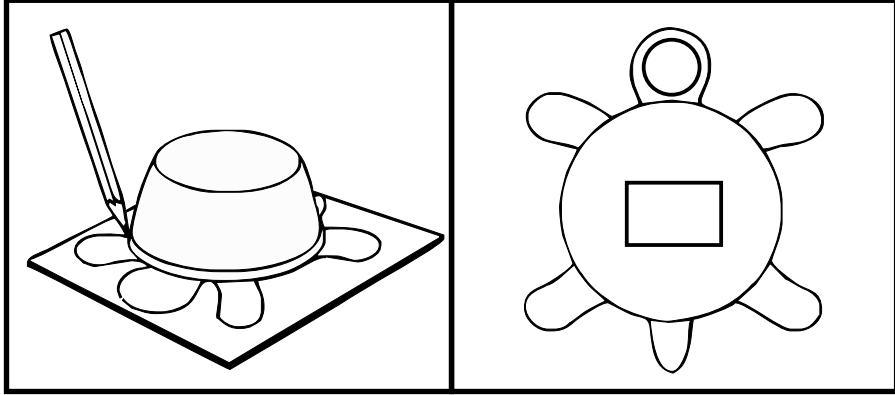

FIGURE 1

FIGURE 2

FIRE ENGINE

MATERIALS

- 1 lt. milk carton (clean)
- ½ lt. milk carton (clean)
- ¼ lt. milk carton (clean)
- cardboard toothpaste box
- plastic strawberry basket
- velcro
- 6 plastic soda caps (for wheels)
- 4 paper fasteners
- tape
- scissors
- red gumdrop (optional)

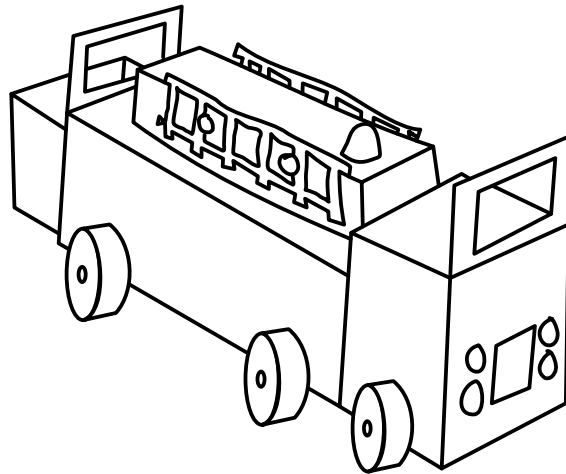

INSTRUCTIONS

1. Cut off three spout flaps from the 1 lt. and ½ lt. milk cartons. Cut a window shape on the remaining flaps. (see fig. 1)
2. Cut off the four spout flaps from the ¼ lt. milk carton. (see fig. 2)
3. Cut the strawberry basket to make ladders. (see fig. 3)
4. Cut the toothpaste box in half lengthwise. (see fig. 4)
5. Lay the 1 lt. milk carton on its side and bend back the windshield. Slide the ¼ lt. milk carton into the opening. Glue two sets of wheels to the 1 lt. milk carton. (see fig. 5)
6. Attach one set of wheels to the ½ lt. milk carton. Use velcro to hold the milk cartons together. (see fig. 6)
7. Hang the ladders on the half toothpaste box using the paper fasteners. Tape box on top of the 1 lt. milk carton. Glue on gumdrop for emergency light. (see fig. 7)

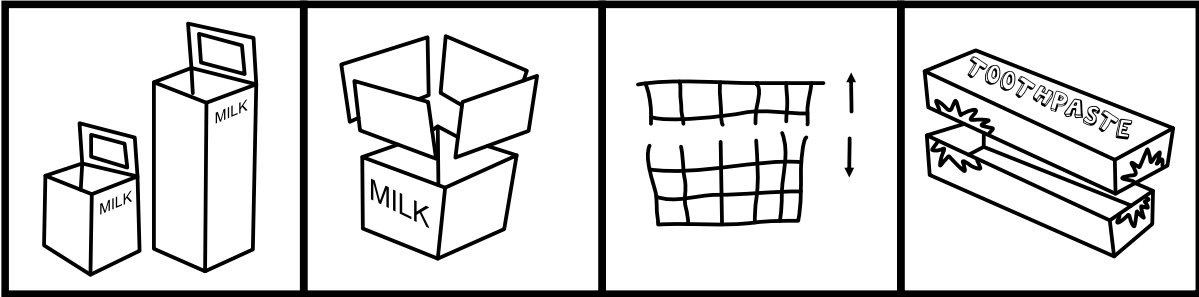

FIGURE 1

FIGURE 2

FIGURE 3

FIGURE 4

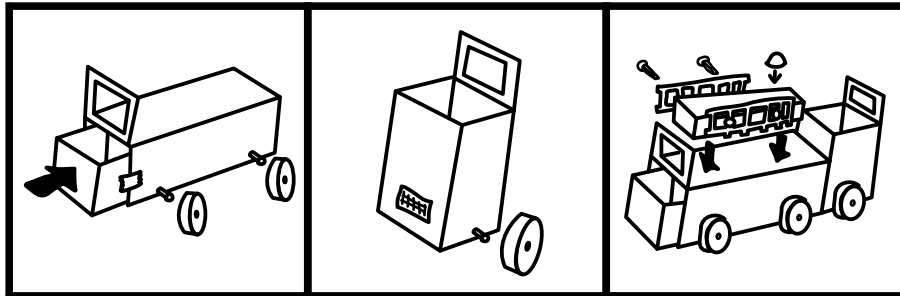

FIGURE 5

FIGURE 6

FIGURE 7

FIREWORKS AND MUSIC PINWHEEL

MATERIALS

- pinwheel pattern (p. 293)
- colors, crayons, markers
- paper fastener or brad
- cardboard (folder, cereal box)
- scissors

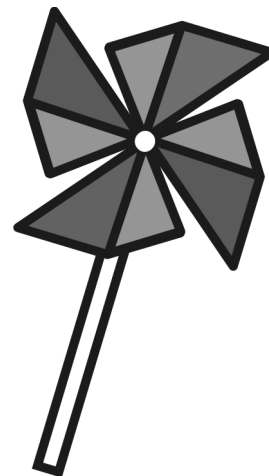

INSTRUCTIONS

1. Color and decorate the pinwheel pattern.
2. Cut out the pattern along the solid line and cut the dotted lines.
3. Fold every other corner in towards the center of the pinwheel.
4. Push a paper fastener through all the paper layers.
5. Cut a long thin strip of cardboard. (about 30 cms. X 2.5 cms.)
6. Push the paper fastener through one end of the cardboard strip and secure to make the pinwheel's handle.
7. Blow on to the pinwheel to make it spin.

FIREWORKS AND MUSIC PINWHEEL PATTERN

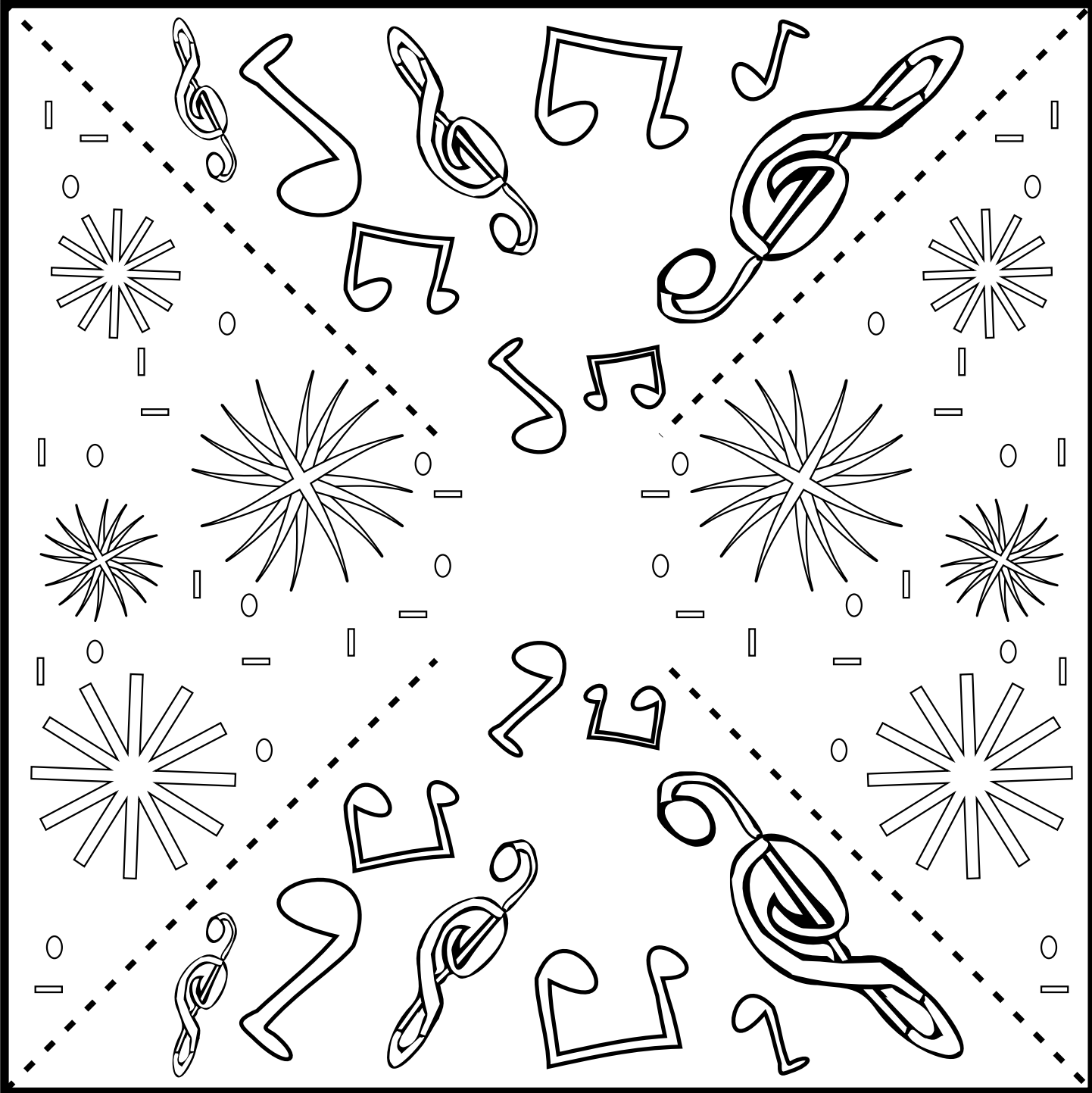

FISHING BOAT

MATERIALS

- 2 1/2 gallon milk cartons (clean)
- 1/4 lt. milk carton (clean)
- nylon net or cheese cloth
- 2 straws
- tape
- scissors
- nail or pointed tool
- gummy fish candy (optional)

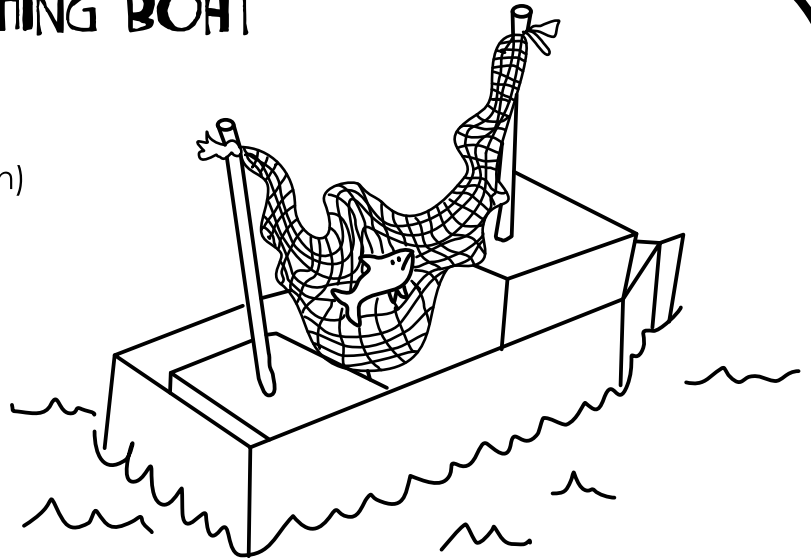

INSTRUCTIONS

1. Cut one 1/2 gallon milk carton in half lengthwise to make the basic boat. (see fig. 1)
2. Cut the second 1/2 gallon milk carton in half horizontally.
3. Cut off the four spout flaps from the 1/4 lt. milk carton. (see fig. 2)
4. Use the nail to poke a hole in the bottom of both these cartons. (see fig. 3)
5. Tape the cartons upside down on the boat. Push the straws through the holes to make masts. Tape the nylon net between the straws and add the fish. (see fig. 4)

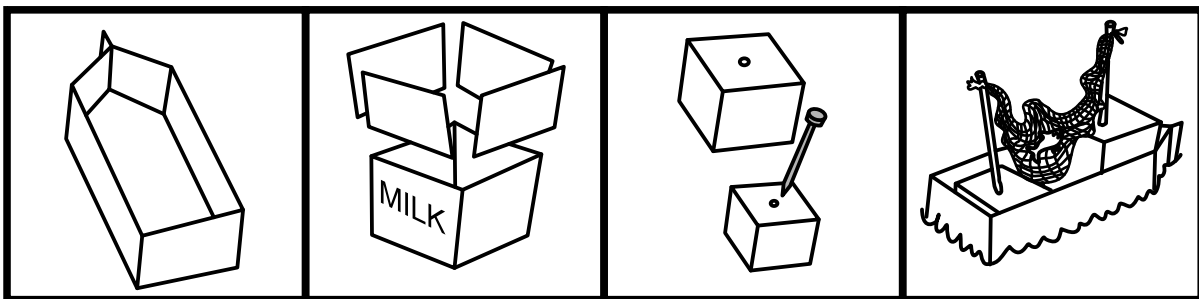

FIGURE 1

FIGURE 2

FIGURE 3

FIGURE 4

FLYING SAUCER

MATERIALS

- 2 heavy paper plates
- paper bowl
- tape or stapler
- scissors
- colored cellophane (optional)

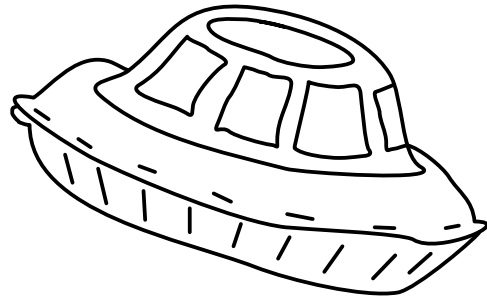

INSTRUCTIONS

1. Cut out openings around the sides and top of the paper bowl for windows. Cover openings with the colored cellophane. (see figs. 1-2)
2. Tape or staple one plate upside down on top of the second plate. Tape the bowl on top of the plates. (see fig. 3)

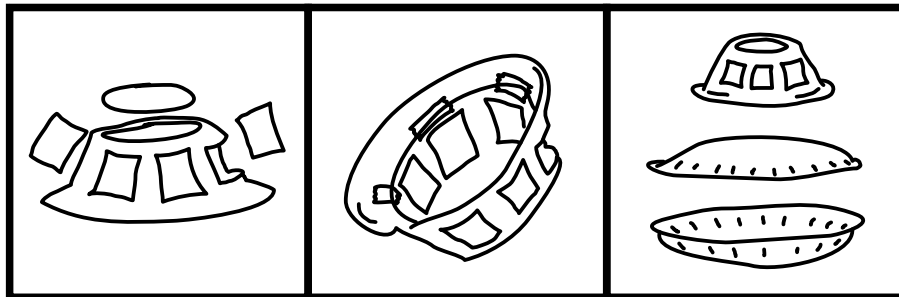

FIGURE 1

FIGURE 2

FIGURE 3

HIGH SPEED TRAIN

MATERIALS

- 3 1 lt. milk cartons (clean)
- tape
- velcro
- glue
- pasta wheels
- scissors

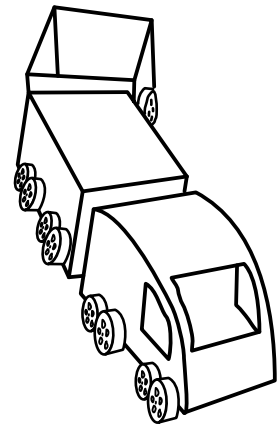

INSTRUCTIONS

1. Open the spouts of all milk cartons. Cut one carton in half lengthwise. Tape one half upside down on top of the other to make a coal car. (see fig. 1)
2. Cut off three spout flaps from the second carton. Cut half-way into the carton along both sides of the remaining flap. (see fig. 2)
3. Bend the flap down, then follow the curve and cut away the corners of the carton. (see fig. 3)
4. Cut out window shapes in the front and sides of the carton. Tape the front down to make a locomotive. (see fig. 4)
5. Tape down spout flaps on third carton. Cut out windows for a passenger car. (see fig. 5)
6. Glue pasta wheels to the cartons. Use velcro to hold the train cars together. (see fig. 6)

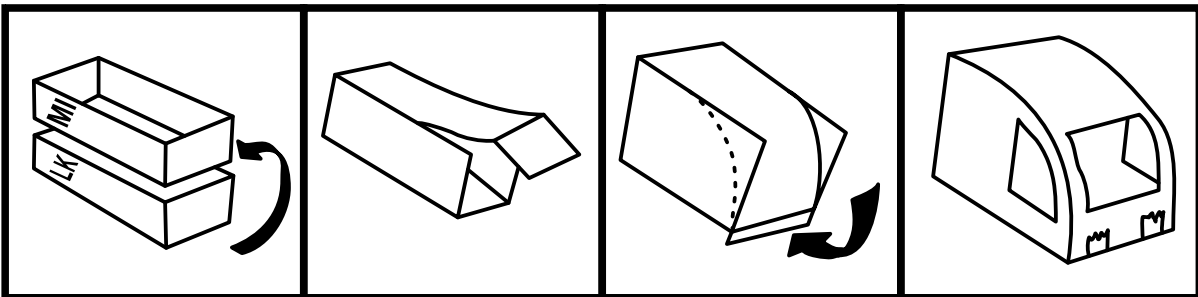

FIGURE 1

FIGURE 2

FIGURE 3

FIGURE 4

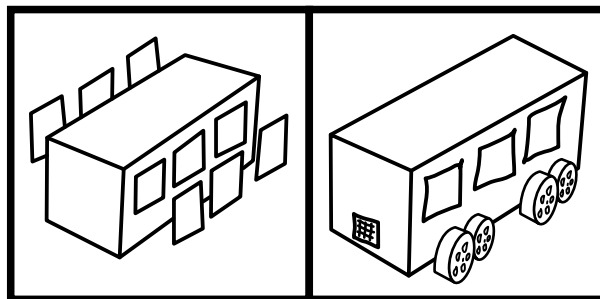

FIGURE 5

FIGURE 6

HOW HIGH CAN YOU FLY?

MATERIALS

- 1 sheet of paper, letter size
- star patterns
- colors, markers, crayons
- scissors
- glue
- 1 paper clip

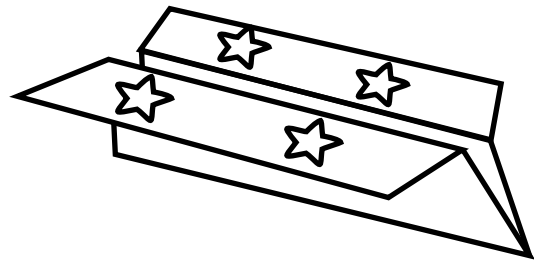

INSTRUCTIONS

1. Fold your paper sheet in half the long way. (see fig. 1)
2. Fold one corner down until it touches the folded edge and repeat on the other side. (see fig. 2)
3. Fold the top edge of one side down to make a wing and repeat on the other side. (see fig. 3)
4. Color and decorate the star patterns and the glider.
5. Cut out the star patterns and glue them onto the glider.
6. Place a paper clip on the bottom of the glider, near the tip. (see fig. 4)
7. Open the wings and throw the glider to see it fly!

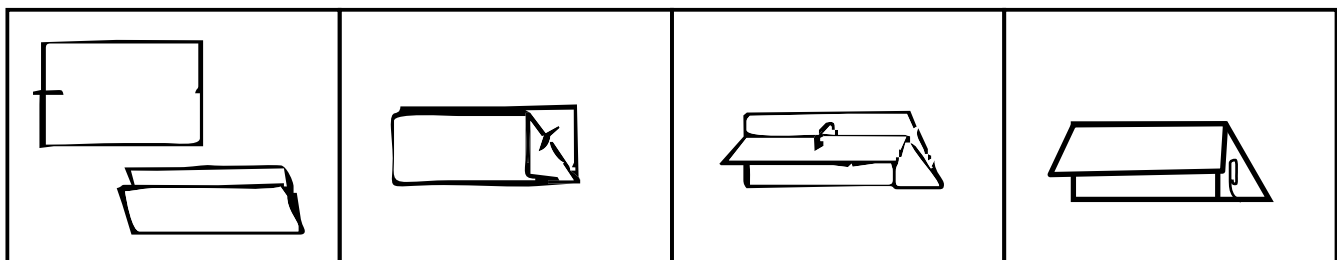
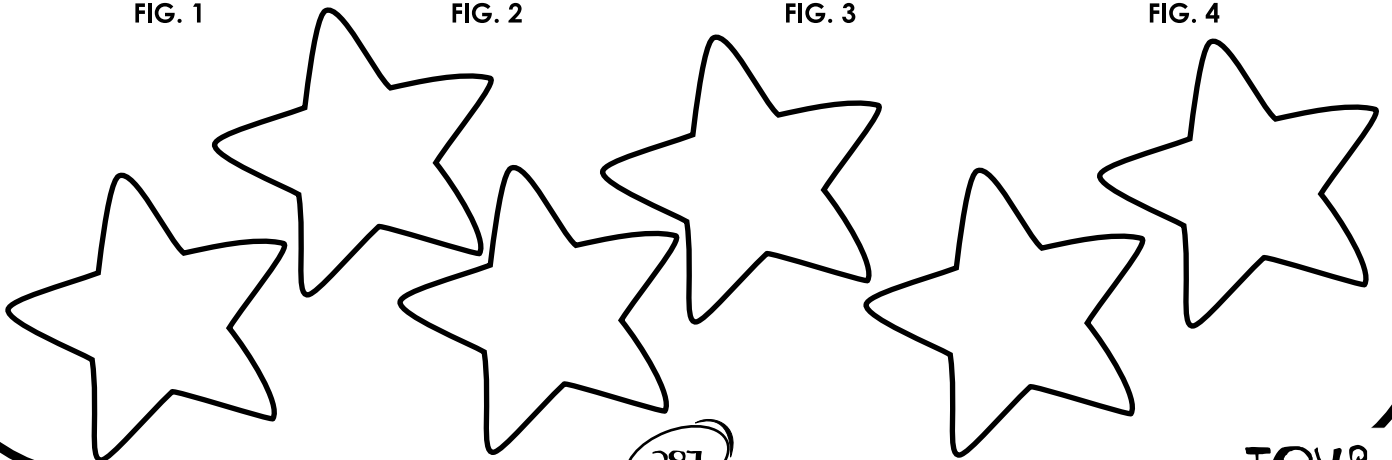

FIG. 1

FIG. 2

FIG. 3

FIG. 4



INDOOR TENNIS RACKET

MATERIALS

- old nylon stocking
- wire coat hanger
- masking tape
- scissors
- aluminum foil

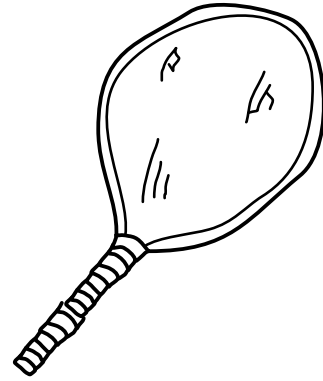

INSTRUCTIONS

1. Bend the shoulders of the hanger to make an oval shape. Straighten the hook to make a handle.
 2. Pull the nylon stocking over the oval. (see fig. 1)
 3. Cut off the excess stocking that hangs below the end of the handle.
 4. Wrap masking tape around and around the stocking and the wire handle to give it shape. (see fig. 2)
 5. Make an aluminum foil ball and bounce it on the racket.
- * Make two rackets and play indoor tennis. *

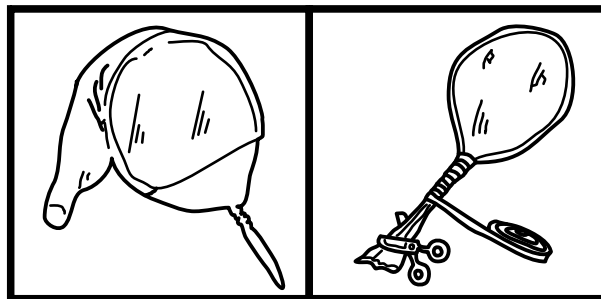

FIGURE 1

FIGURE 2

JAPANESE CARP KITE

MATERIALS

- large paper cup
- markers
- scissors
- crêpe paper
- stapler
- string

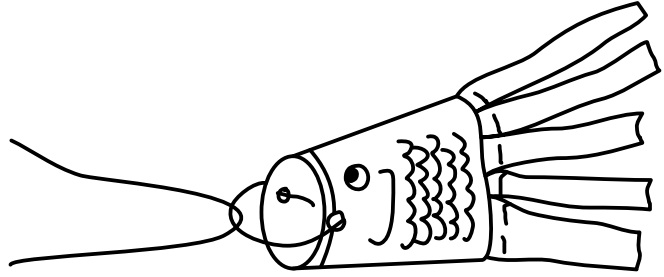

INSTRUCTIONS

1. Cut off the bottom of the paper cup.
2. The smaller end of the cup will be the fish's mouth. Use the markers to draw eyes, gills, and fins. (see fig. 1)
3. Cut the crêpe paper into long strips to make streamers. Staple streamers to the large end of the cup.
4. Poke two holes on opposite sides of the fish's mouth. Thread a short length of string through the two holes and knot the ends. Tie a long piece of string to the center of the short string so you can fly your kite. (see fig. 2)

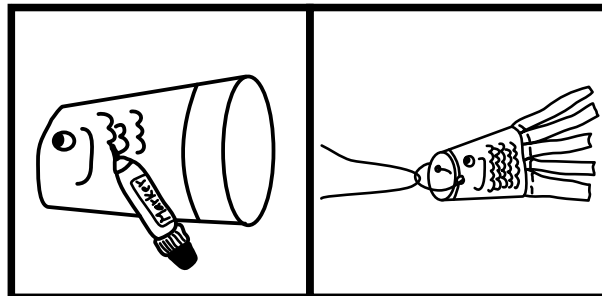

FIGURE 1

FIGURE 2

JET PLANE

MATERIALS

- patterns (p. 301)
- styrofoam plate
- aluminum foil
- tape
- scissors
- pencil

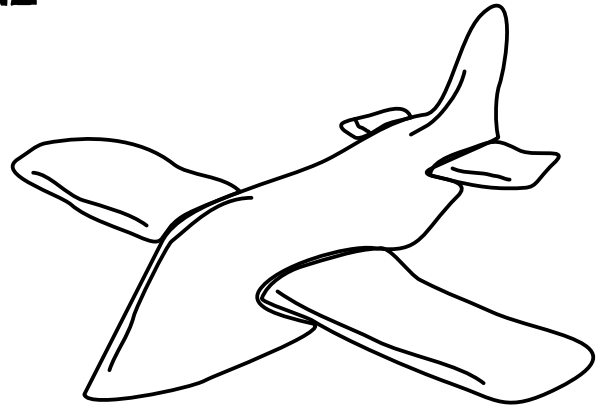

INSTRUCTIONS

1. Cut off the rim of the plate. Trace the patterns onto the center of the plate and cut out. Cut slits on the plane's body to insert the wings. (see fig. 1)
2. Wrap the wings and body of the plane in aluminum foil and tape in place. Slide the wings through the slits in the plane's body. (see fig. 2)
3. Throw your plane and see how far it flies.

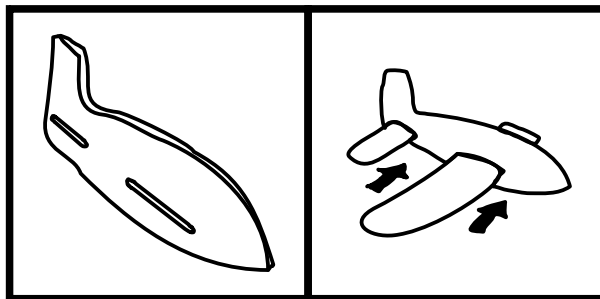
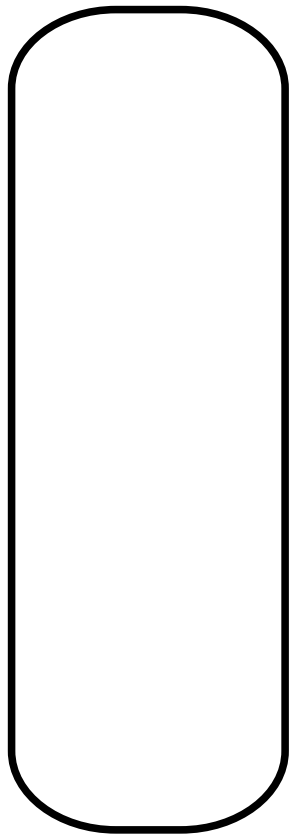
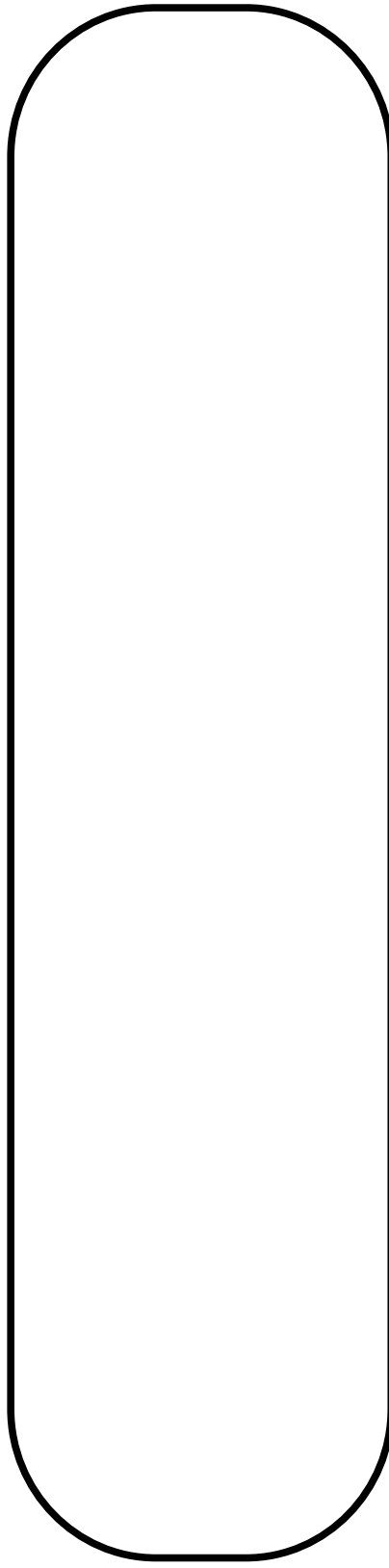
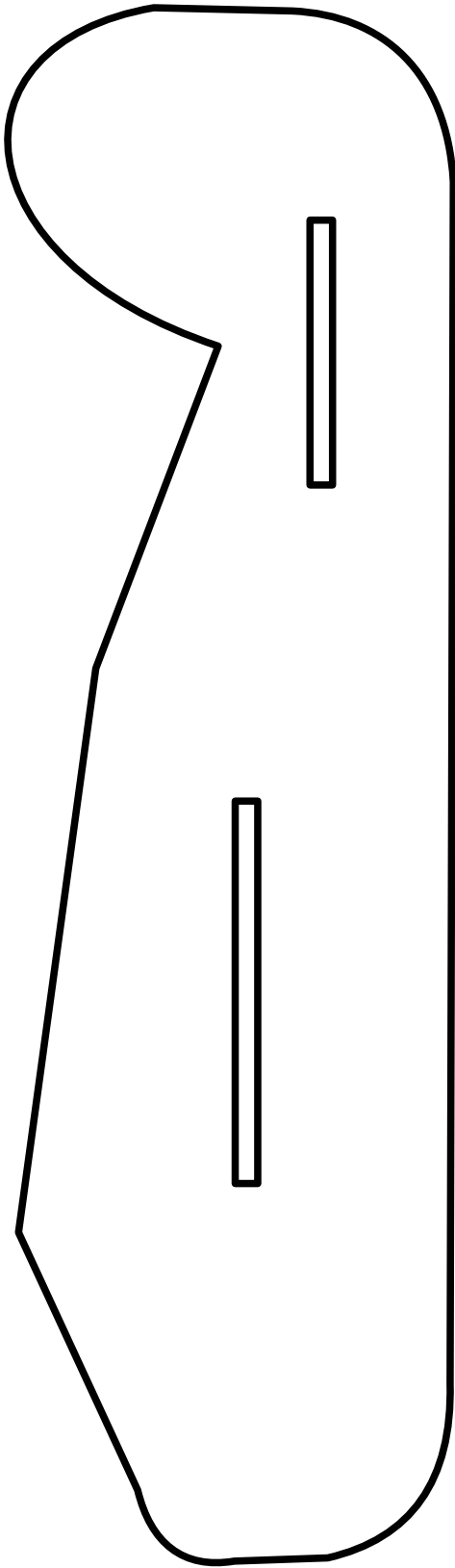

FIGURE 1

FIGURE 2



MILK CARTON TRAFFIC LIGHT

MATERIALS

- 1 lt. milk carton (clean)
- construction paper (black, red, yellow, green)
- string
- tape
- glue
- scissors

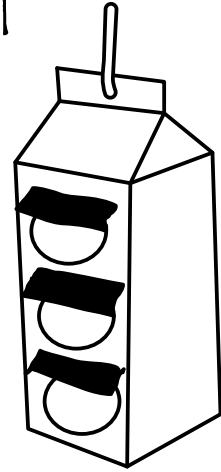

INSTRUCTIONS

1. Tape the spout flaps closed. Cut a hole through the spout of the milk carton. (see fig. 1)
2. Cut same sized circles from red, green, and yellow construction paper.
3. Cut three long, thin rectangles from black construction paper. (see fig. 2)
4. Wrap the milk carton with the black construction paper and tape in place. Glue the circles onto the carton in a traffic light pattern, and tape the small rectangles above. Tie the string through the hole to hang your light. (see fig. 3)

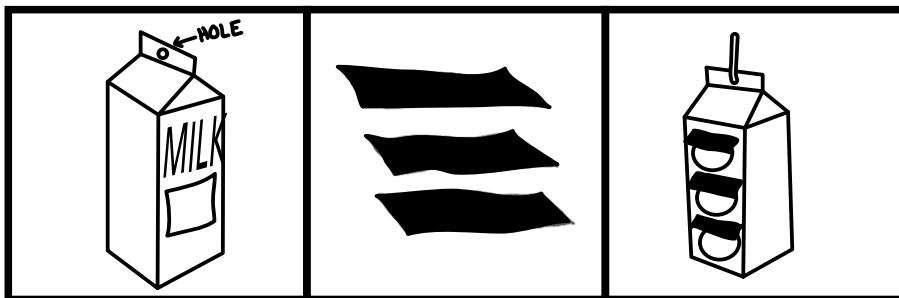

FIGURE 1

FIGURE 2

FIGURE 3

MINI GOLF

MATERIALS

- 12 half kilo cans (clean)
- acrylic paint, white and black
- oil paint, assorted colors
- paintbrushes
- hot glue gun
- wooden sticks, 1.2 cms. diameter x 80 cms. long
- sponge material
- small plastic or ping pong ball
- golf pattern (p. 304)
- thick cardboard (box)
- scissors

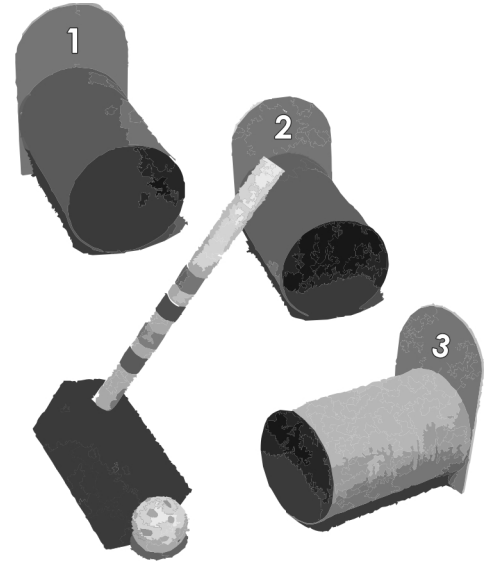

INSTRUCTIONS

1. Paint the cans black on the inside and white on the outside (first coat). Let dry.
2. Paint them again on the outside with the oil paints (colors of your choice) and let dry.
3. Use the pattern to trace the figure 12 times onto the thick cardboard and cut them out.
4. Paint the pieces and draw or paint the numbers from 1 to 12 on each one at the top.
5. Glue at the back of each can. (see example)
6. Paint the sticks white and let dry.
7. Cut out sponge rectangles 7.5 cms. long x 2.5 cms. wide and glue to the tip of each stick to make a golf club. (see fig. 1)
You're ready to play!

MINI GOLF PATTERN

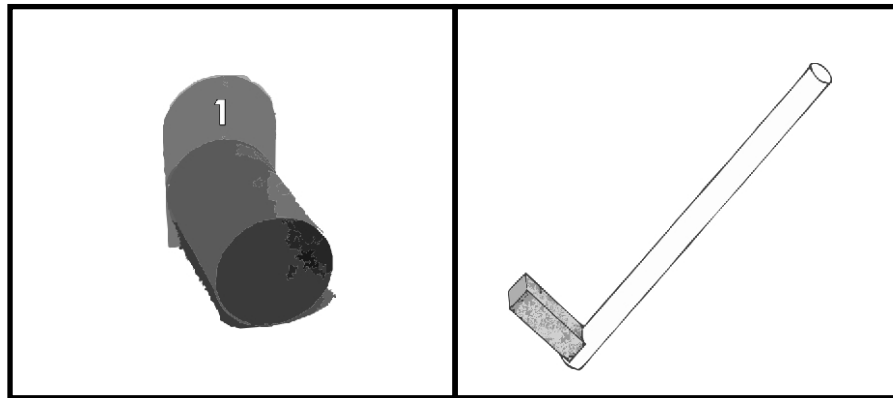

EXAMPLE

FIGURE 1

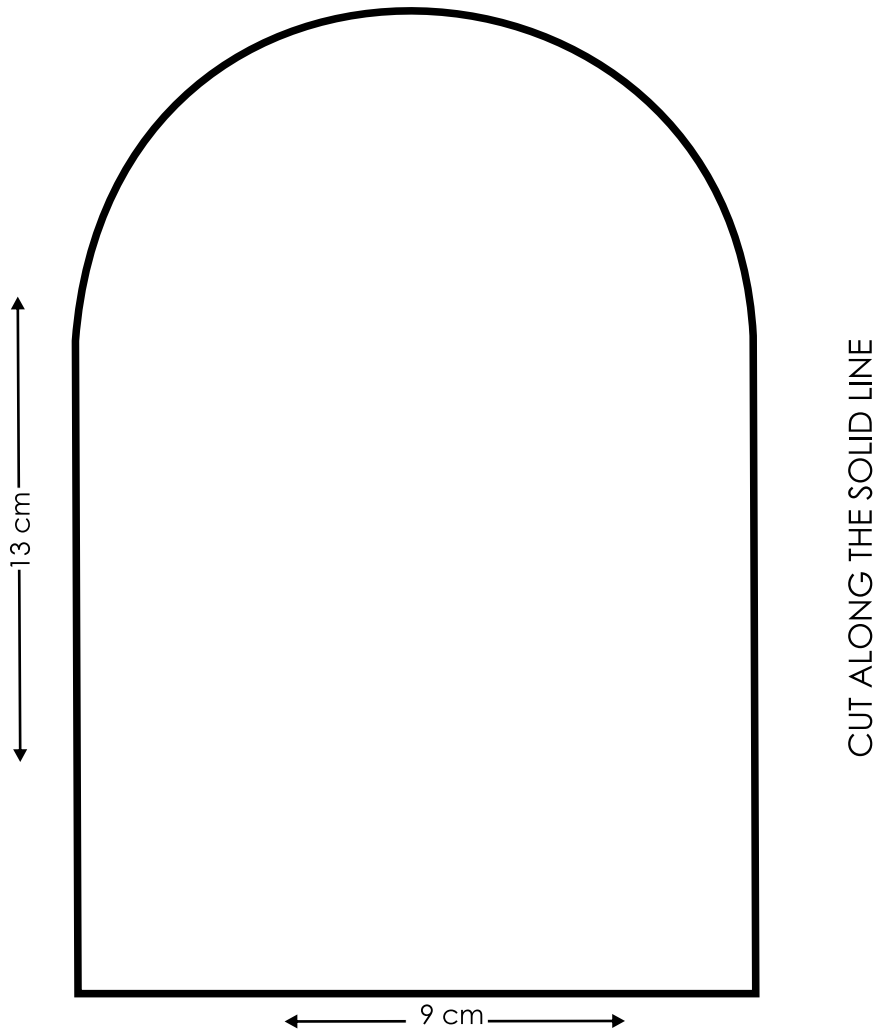

MINI VAN

MATERIALS

- 1/2 gallon milk carton (clean)
- tape
- scissors
- 4 plastic soda caps (for wheels)

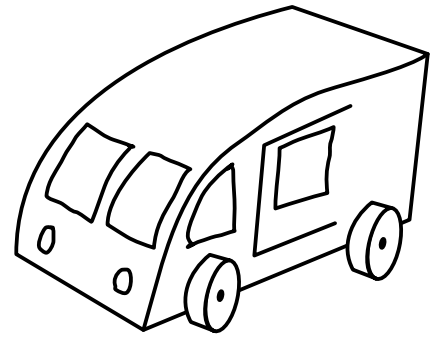

INSTRUCTIONS

1. Cut off three spout flaps from the milk carton. Cut half-way into the carton along both sides of the remaining flap. (see fig.1)
2. Bend the flap down, then follow the curve and cut away the corners of the carton. (see fig. 2)
3. Cut windows in the front and a door in the side of the carton. Tape the flap and attach the wheels for the mini van. (see fig. 3)

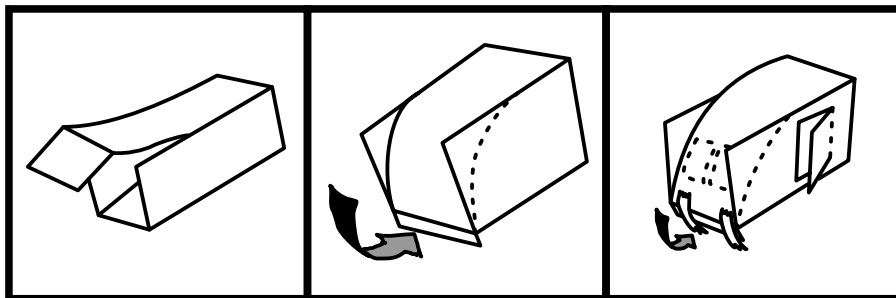

FIGURE 1

FIGURE 2

FIGURE 3

MOON BUGGY

MATERIALS

- 1/2 lt. milk carton (clean)
- tape
- scissors
- 4 plastic soda caps (for wheels)
- straw
- scrap paper
- aluminum foil

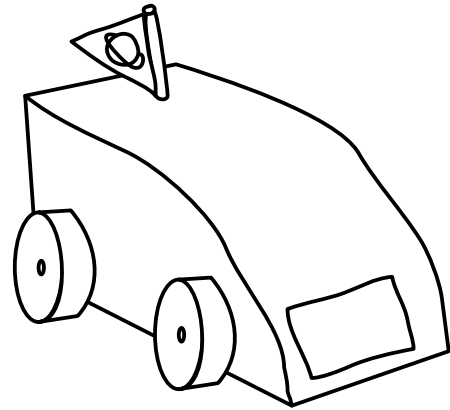

INSTRUCTIONS

1. Cut off three spout flaps from the milk carton. Cut half-way into the carton along both sides of the remaining flap. (see fig. 1)
2. Bend the flap down, then follow the curve and cut away the corners of the carton. (see fig. 2) Tape in place.
3. Cut windows in the front, wrap in aluminum foil, and cut a small hole at the top. Make a small flag out of scrap paper, tape it to the straw, and insert straw in the hole. (see fig. 3)
4. Glue soda caps on for wheels.

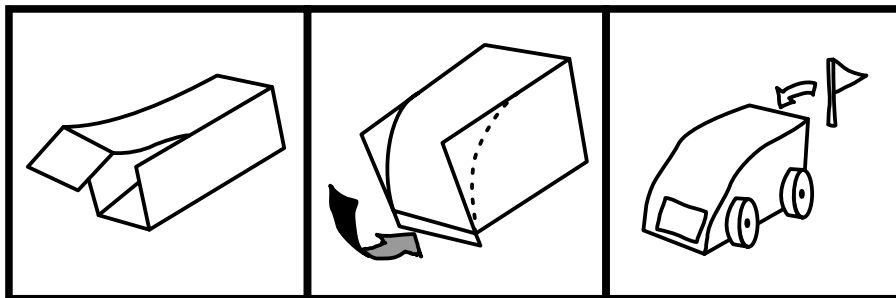

FIGURE 1

FIGURE 2

FIGURE 3

PAPER PINE TREES

MATERIALS

- green construction paper
- popsicle sticks
- egg carton
- glue
- scissors
- pattern (p. 308)
- pencil

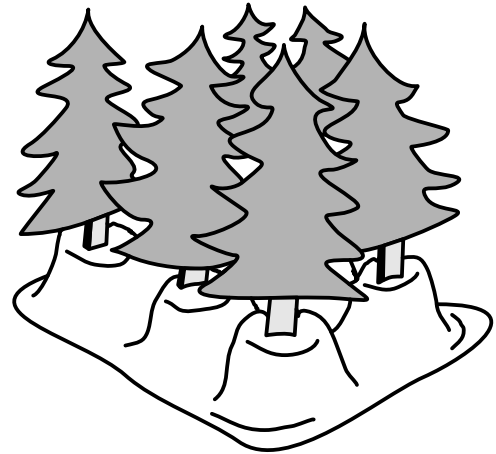

INSTRUCTIONS

1. Trace tree pattern onto green construction paper, Two pattern pieces for each tree you are going to make. Cut out. (see fig. 1)
2. Cut the egg carton in groups of six cups. (see fig. 2)
3. Glue trees onto popsicle sticks. One for the front and one for the back. (see fig. 3)
4. Turn the egg carton sections upside down. Dip the bottom of the popsicle sticks in glue and stick them into the bottom of the egg carton cups to make forest sections. (see example)

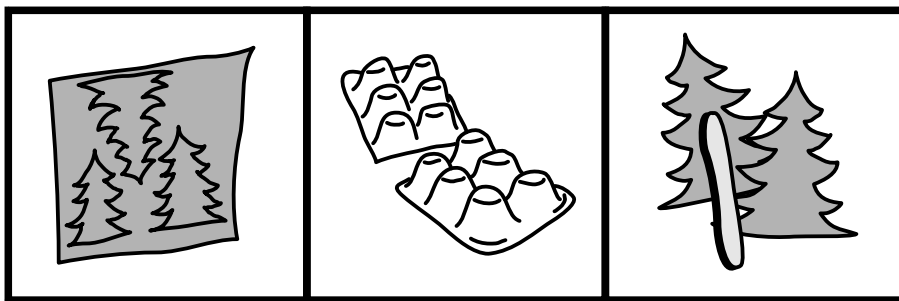
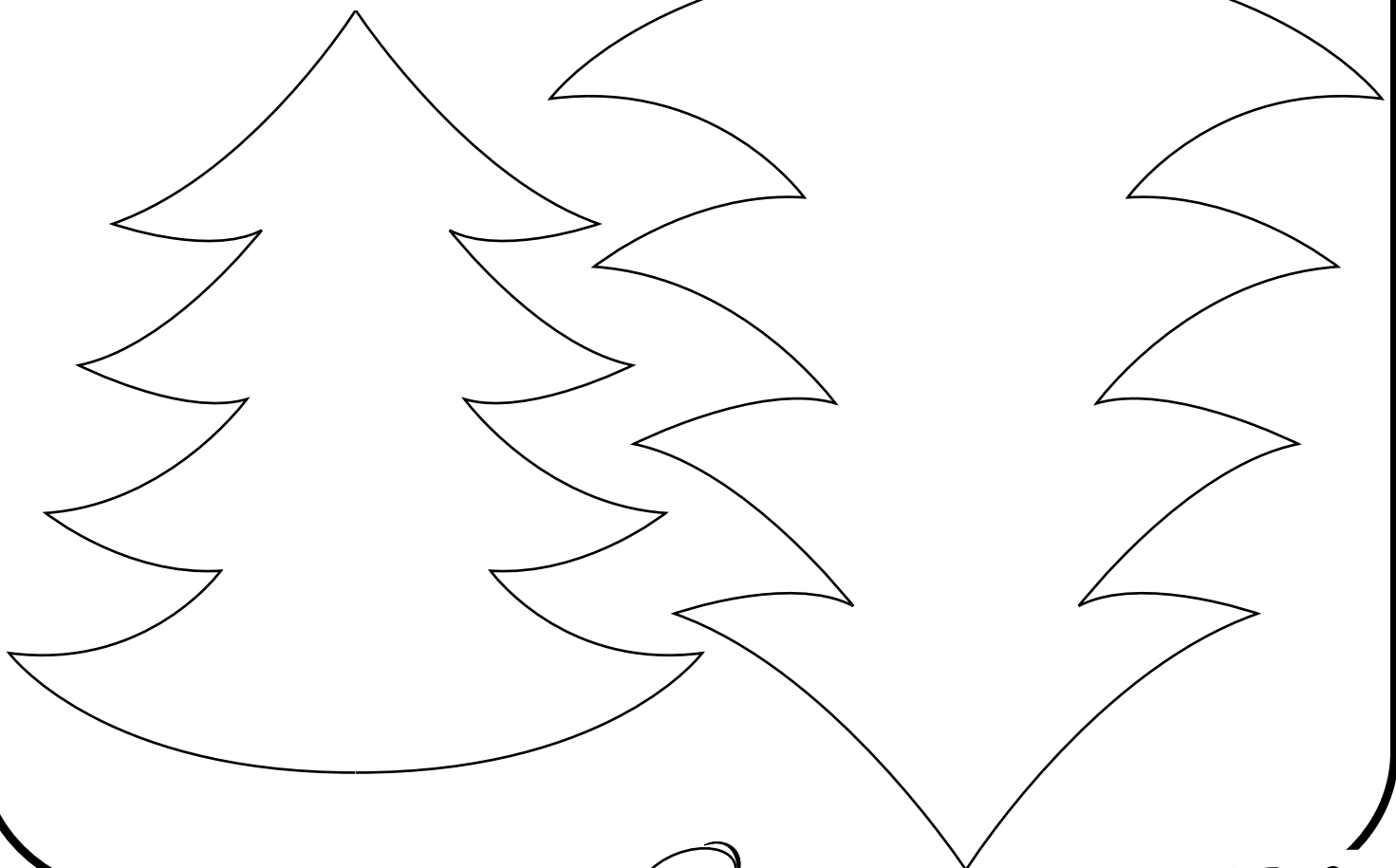
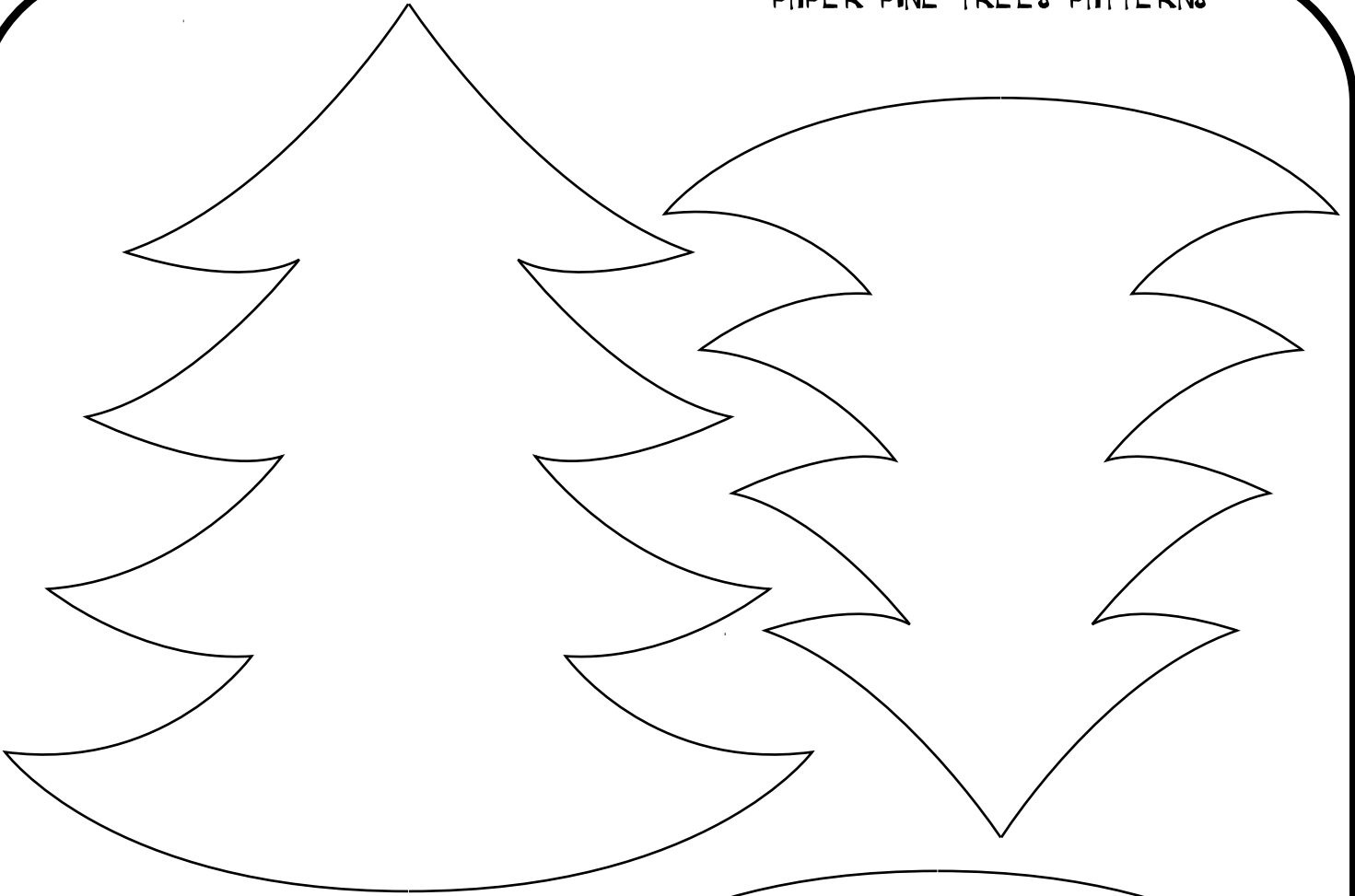

FIGURE 1

FIGURE 2

FIGURE 3

PAPER PINE TREES PATTERNS



POLICE VAN

MATERIALS

- 1/4 lt. milk carton (clean)
- 1/2 lt. milk carton (clean)
- velcro
- 6 plastic soda caps (for wheels)
- scissors
- red gumdrop (optional)

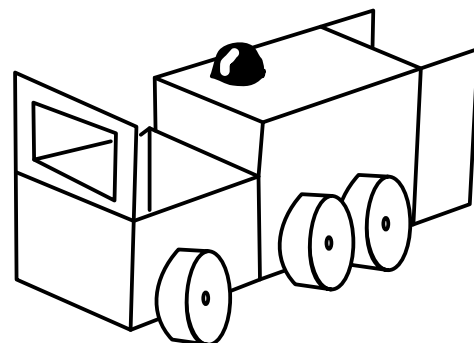

INSTRUCTIONS

1. Cut off three spout flaps from 1/4 liter milk carton. Cut out a window shape on remaining flap. (see fig. 1)
2. Cut off two opposite spout flaps from the 1/2 lt. milk carton to make the van. (see fig. 2)
3. Use velcro to attach cab and van together. Glue on plastic soda caps for wheels. (see fig. 3)
4. Glue red gumdrop on top for emergency light. (see example)

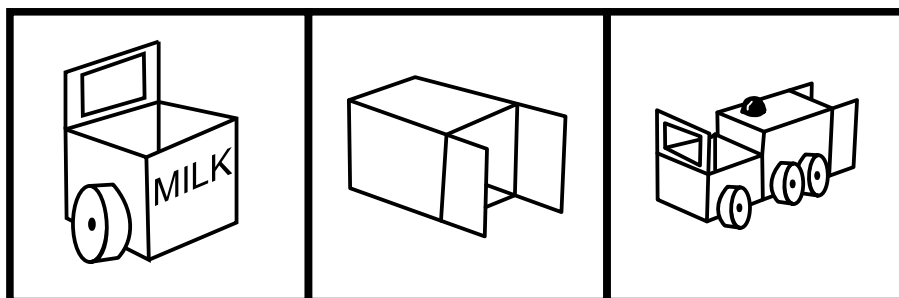

FIGURE 1

FIGURE 2

FIGURE 3

PRETZEL LOG CABIN

MATERIALS

- 1/4 lt. milk carton (clean)
- stick pretzels
- glue
- wax paper
- table knife
- construction paper

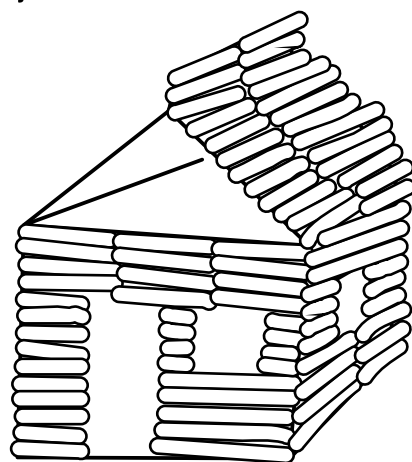

INSTRUCTIONS

1. Cover your work surface with wax paper.
2. Glue the milk carton spout closed.
3. Make windows and a door shape from construction paper, cut out, and glue in place onto the milk carton. (see fig. 1)
4. Glue one pretzel at a time onto the sides and top of the milk carton until it is completely covered. (see fig. 2)

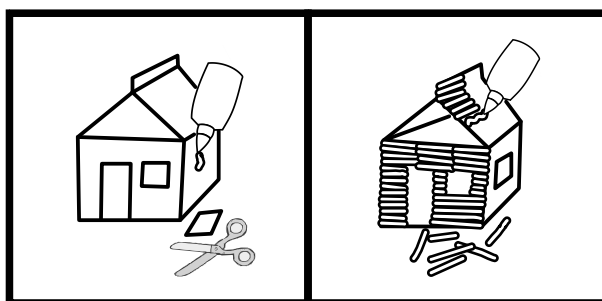

FIGURE 1

FIGURE 2

ROCKING HORSE

MATERIALS

- paper plate
- toilet paper tube
- construction paper
- yarn
- scissors
- glue
- crayons or markers
- pattern (p. 312)

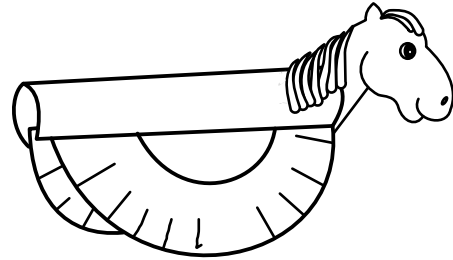

INSTRUCTIONS

1. Fold the paper plate in half.
2. Cut the toilet paper tube from end to end. Slide the folded side of the paper plate into the slit of the toilet paper tube and glue in place. (see fig. 1)
3. Fold the construction paper in half and trace the horse's head pattern. Cut out. Draw on the face with markers or crayons. (see fig. 2)
4. Glue the neck ends of the horse's head to the sides of the toilet paper tube.
5. Use the yarn to make the horse's mane and tail. Glue in place.
6. Pull the edges of the paper plate slightly apart to make the rocker.

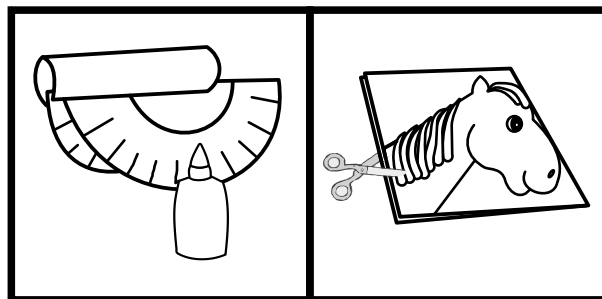
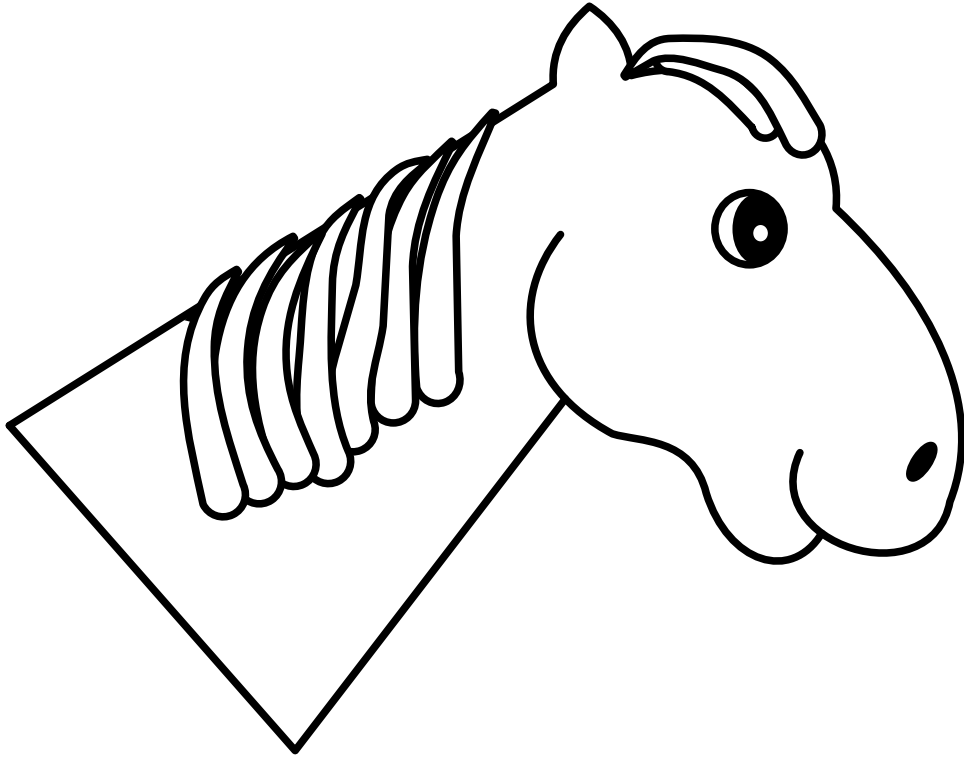

FIGURE 1

FIGURE 2

ROCKING HORSE PATTERN



ROWBOAT

MATERIALS

- 1/2 lt. milk carton (clean)
- 2 popsicle sticks
- tape
- scissors
- nail or pointed tool

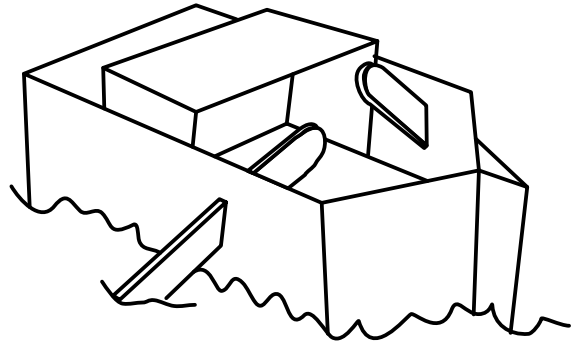

INSTRUCTIONS

1. Cut the milk carton in half lengthwise to make a boat shape. (see fig. 1)
2. Cut 2.5 cms. off the bottom of the remaining half milk carton to make a bench. (see fig. 2)
3. Using the nail, punch small holes at each side of the boat. (see fig. 3)
4. Push popsicle sticks through the holes for oars. Tape the bench inside the boat. (see example)

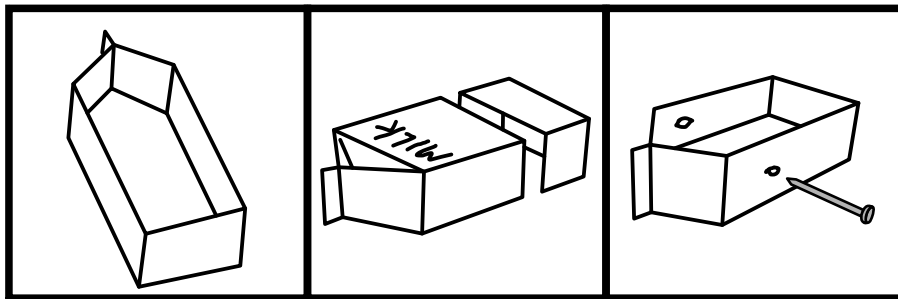

FIGURE 1

FIGURE 2

FIGURE 3

SAILBOAT

MATERIALS

- 2 half gallon milk cartons (clean)
- straw
- construction paper scraps
- tape
- scissors
- nail or pointed tool

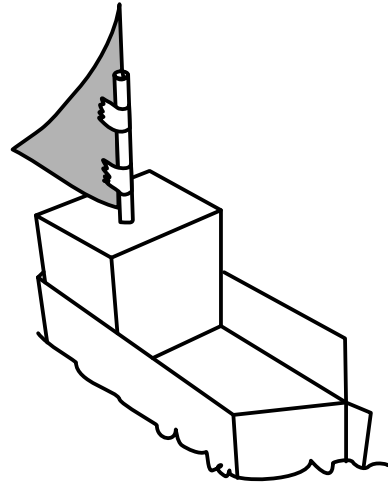

INSTRUCTIONS

1. Cut the milk carton in half lengthwise to make a boat shape. (see fig. 1)
2. Cut the second milk carton in half horizontally. (see fig. 2)
3. Use the nail to poke a hole in the bottom of the half milk carton. (see fig. 3)
4. Cut a slit halfway into the straw. (see fig. 4)
5. Tape the half carton upside down in the boat. Push the straw into the hole to make a mast. Cut a sail shape from the construction paper scraps, slide it into the straw's slit, and tape in place. (see example)

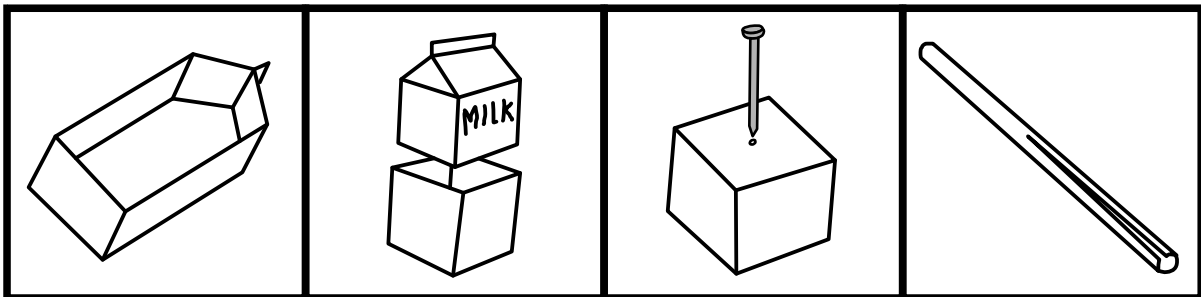

FIGURE 1

FIGURE 2

FIGURE 3

FIGURE 4

SHOE BOX GARAGE

MATERIALS

- cardboard shoe box with lid
- glue
- markers
- tape
- scissors

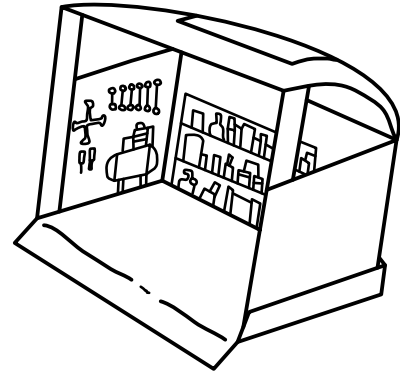

INSTRUCTIONS

1. Cut off the front panel of the shoe box. Also cut along the bottom edges of the box to make a flap. Cut out a rectangle in the center of the flap you just made. (see fig. 1)
2. Cut the resulting rectangle in half. (see fig. 2)
3. Cut one edge of the lid so that it is flat. Turn the box upside down on the lid and tape the rectangle halves to the sides to make a curved roof for your garage. (see fig. 3)
4. Use markers to draw shelves and tools.

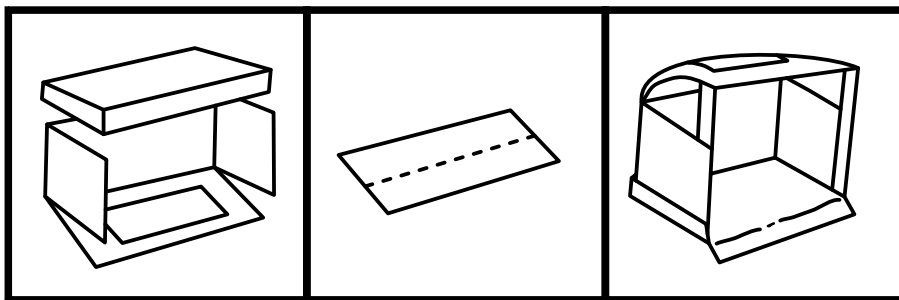

FIGURE 1

FIGURE 2

FIGURE 3

SPACE SHUTTLE

MATERIALS

- toilet paper tube
- cardboard (folder, cereal box)
- aluminum foil
- tissue paper streamers (red, orange, yellow)
- tape
- scissors

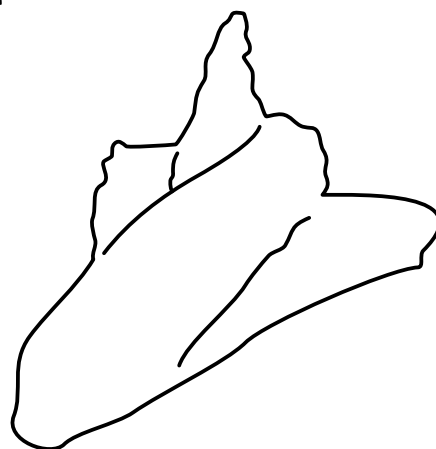

INSTRUCTIONS

1. Cut slits around one end of the toilet tube approx. 2 cms. apart from each other. Cut one slit on the other end 2 cms. before the edge. (see fig. 1)
2. Trace the patterns onto cardboard and cut out.
3. Tape together the slits in one end of the toilet tube to make a pointed shape. Wrap in aluminum foil.
4. Wrap the wings and tail in aluminum foil. Tape the tube onto the wings, and push tail through the end slit. (see fig. 2)
5. Tape tissue paper streamers inside the tail end of the space shuttle for flames.

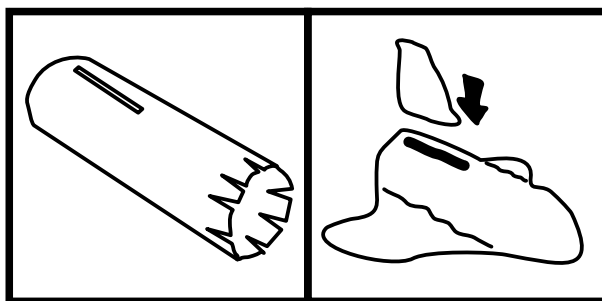

FIGURE 1

FIGURE 2

STEAM ROLLER

MATERIALS

- 1/4 Lt. milk carton (clean)
- 1/2 Lt. milk carton (clean)
- pasta box
- toilet paper tube
- 2 paper fasteners
- cardboard (folder, cereal box)
- tape
- pipe cleaner
- scissors
- nail
- 2 plastic caps from a 20 Lt. water bottle

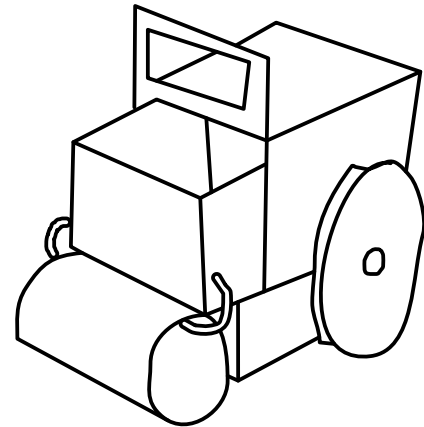

INSTRUCTIONS

1. Cut off three spout flaps from 1/2 Lt. milk carton. Cut out a window shape on remaining flap. (see fig. 1)
2. Cut off the four spout flaps from the 1/4 Lt. milk carton. (see fig. 2)
3. Trace the outline of the plastic caps onto the cardboard and cut out. (see fig. 3)
4. Cut the pasta box in half horizontally. (see fig. 4)
5. Tape 1/2 Lt. milk carton on its side to the top of the half pasta box. Bend the windshield and slide the 1/4 Lt. milk carton into the opening. (see fig. 5)
6. Use nail to punch a hole through the cardboard wheels and the plastic bottle caps. Put a paper fastener through both and attach to the pasta box. (see fig. 6)
7. Use the nail to punch small holes at the sides of the 1/4 Lt. milk carton. (see fig. 7)
8. Put the pipe cleaner through the toilet paper tube and then through the small holes in the 1/4 Lt. milk carton. Tape in place. (see fig. 8)

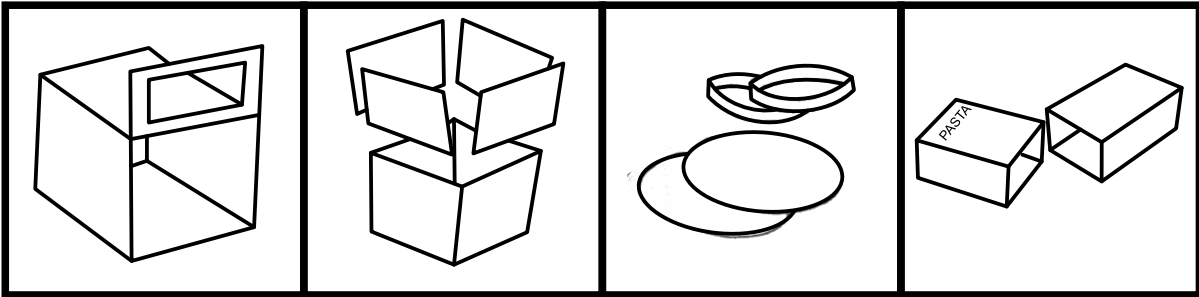

FIGURE 1

FIGURE 2

FIGURE 3

FIGURE 4

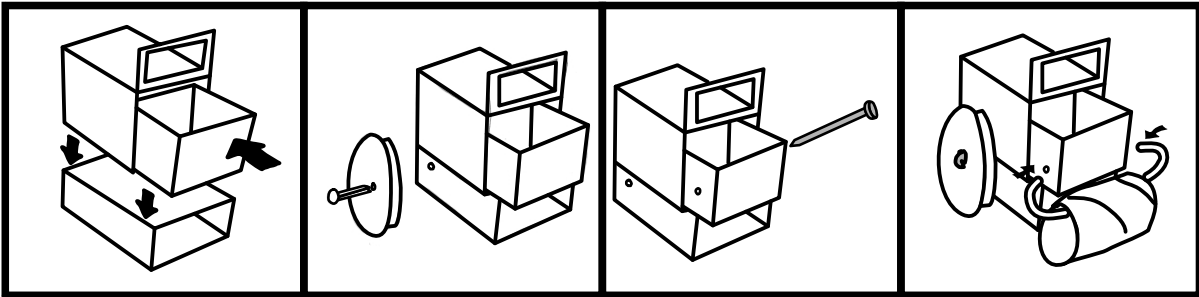

FIGURE 5

FIGURE 6

FIGURE 7

FIGURE 8

SUBMARINE

MATERIALS

- paper towel tube
- 1 egg carton cup
- pipe cleaner
- aluminum foil
- flexible straw
- glue
- tape
- scissors

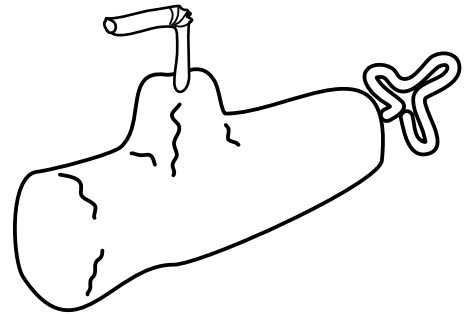

INSTRUCTIONS

1. Cut slits around both ends of the paper towel tube approx. 2 cms. apart from each other. (see fig. 1)
2. Squeeze the slits together and tape in place to close both ends. Tape the egg carton cup on top to make a submarine shape. (see fig. 2)
3. Wrap the submarine in aluminum foil. Twist the pipe cleaner into a propeller shape, and glue to the back end of the submarine. (see fig. 3)
4. Cut the straw in half, and glue the bendable part on top of the submarine for a periscope. (see fig. 4)

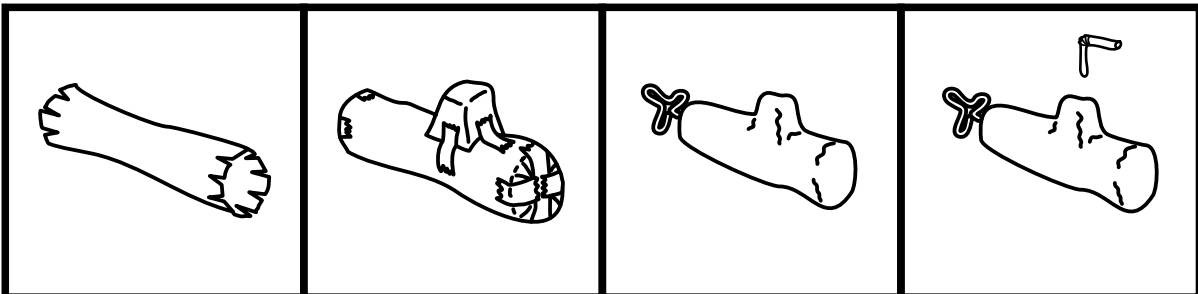

FIGURE 1

FIGURE 2

FIGURE 3

FIGURE 4

POPSICLE STICK TRAIN TRACK

MATERIALS

- popsicle sticks
- heavy paper or construction paper (letter size)
- glue
- tape

INSTRUCTIONS

1. Tape the paper end to end to make one long sheet.
2. Glue popsicle sticks lengthwise onto the paper. Glue crosswise sticks to make a train track. (see example)

